



DS Implants™

DS OmniTaper™  
Surgical manual

 Dentsply  
Sirona

This manual is designed for use by clinicians who have undergone at least basic prosthetic and in-clinic implant training. Staying current on the latest trends and treatment techniques in implant dentistry through continued education is the responsibility of the clinician.

All products may not be regulatory cleared/released/licensed in all markets. Please contact the local Dentsply Sirona sales office for current product assortment and availability.

To improve readability for our customers, Dentsply Sirona does not use ® or ™ in body copy. However, Dentsply Sirona does not waive any right to the trademark and nothing herein shall be interpreted to the contrary.

Product illustrations are not to scale.

# CONTENTS

<b>1. Introduction to DS OmniTaper</b> .....	4
Implant design.....	4
Color coding.....	5
Implant-abutment connection.....	5
Restorative solutions.....	5
TempBase.....	6
Bone-specific preparation protocol.....	7
<b>2. Treatment planning</b> .....	8
Conventional treatment planning.....	8
Computer-guided treatment planning.....	8
Clinical application.....	9
Torque guide.....	9
<b>3. Instruments</b> .....	10
Drills.....	10
Try-in Implant.....	12
Implant Driver.....	13
Torque Wrench.....	13
Hex Driver.....	14
Surgical Tray.....	14
<b>4. Implant site preparation</b> .....	16
Procedure .....	16
<b>5. Implant packaging</b> .....	19
<b>6. Implant installation</b> .....	20
Standard procedure.....	20
One-stage surgical protocol procedure.....	22
Two-stage surgical protocol procedure.....	23
<b>7. Index registration</b> .....	24
TempBase index registration procedure.....	24
<b>8. Guided Surgery</b> .....	26
Computer-guided 3D planning and implant installation.....	26
<b>9. Instruments Guided Surgery</b> .....	27
Mucosal Punch.....	27
Drills.....	27
Implant Driver.....	28
Stabilization Abutment.....	28
Positioning Aid.....	28
Surgical Tray Guided Surgery.....	29
<b>10. Simplant SAFE Guide</b> .....	30
Types of support.....	30
Tooth-supported procedure.....	31
Bone-supported procedure.....	31
Mucosa-supported procedure.....	32
<b>11. Implant site preparation - Guided Surgery</b> .....	33
<b>12. Implant installation - Guided Surgery</b> .....	36

# 1. Introduction to DS OmniTaper



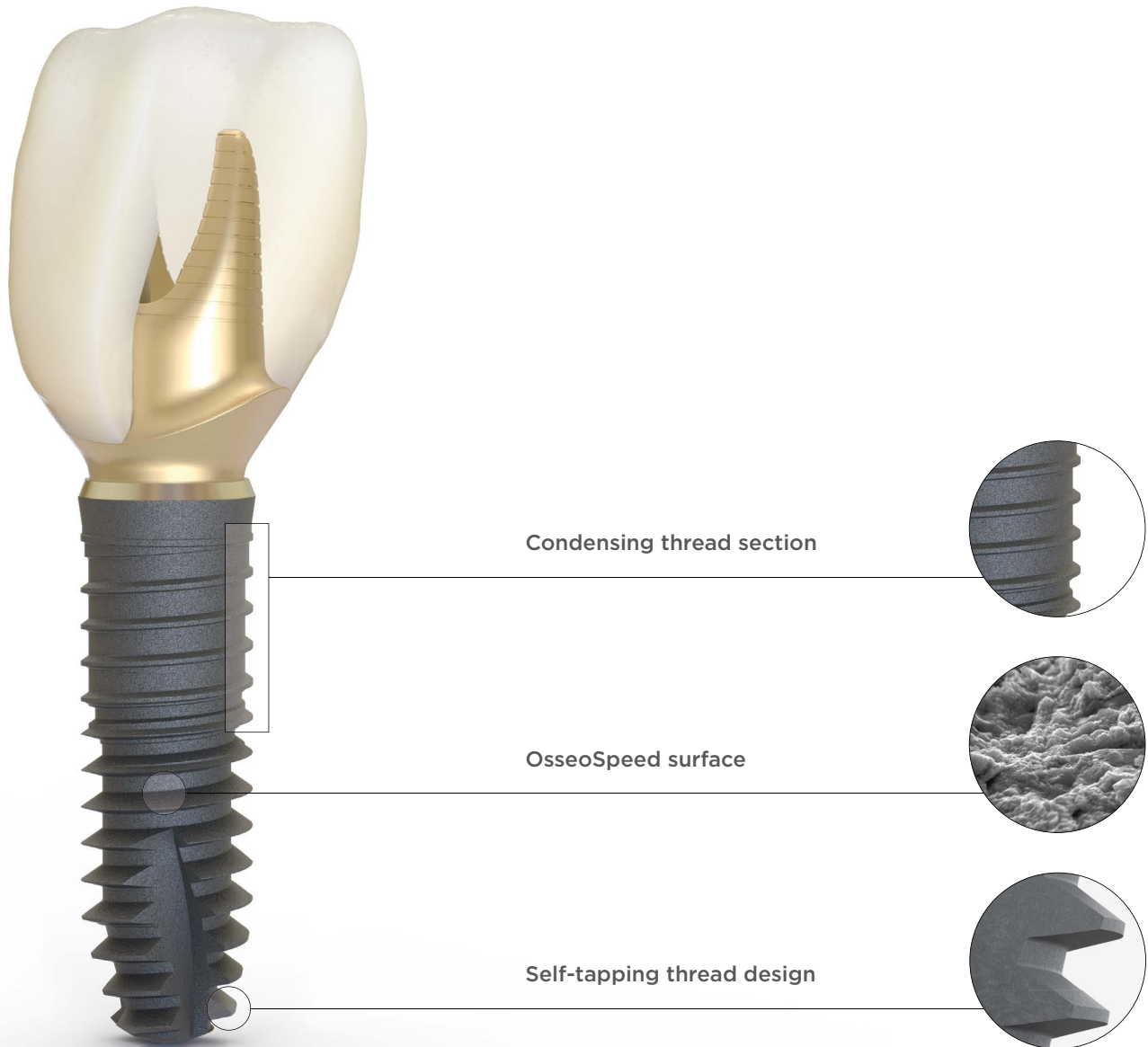

## Implant design

The DS OmniTaper implant with the OsseoSpeed surface is designed with a combination of a tapered implant body and special thread design. The specific, patented thread design with a condensing crestal section is a component of the bone-specific preparation protocol.



## Color coding

The DS OmniTaper implant is available in five diameters and six lengths. The color coding makes it easy to identify the right connection, diameter and to select the right prosthetic components.

Implant Ø	3.0mm	3.4mm	3.8mm	4.5mm	5.5mm
Connections					
Lengths	-	-	8mm	8mm	8mm
	-	9.5mm	9.5mm	9.5mm	9.5mm
	11mm	11mm	11mm	11mm	11mm
	13mm	13mm	13mm	13mm	13mm
	15mm	15mm	15mm	15mm	15mm
	-	18mm	18mm	18mm	-

## Implant-abutment connection

The implants have a unique interface providing three different options for abutment placement/indexing.

- **One-position-only**

Atlantis patient-specific, abutments will seat in one position only.



- **Six positions**

Indexed abutments will seat in six available positions. Including pre-surgically manufactured Atlantis abutments.



- **Non-indexed**

Non-indexed abutments will be seated in any rotational position.

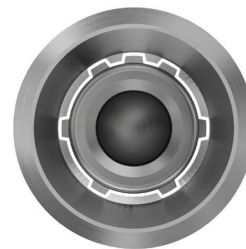

## Restorative solutions

The implants portfolio offers prefabricated and patient-specific abutments. Restorations include prosthetic options on implant and abutment levels, with various possibilities for type of fixation e.g. screw-, cement-, friction- and attachment-retained solutions.

## TempBase

TempBase is multi-functional:

- premounted as a placement head on DS OmniTaper implants
- used for index impression (with TempBase Cap)
- a basis for temporary restorations (with TempBase Cap).

### One-stage surgical protocol

- Chairside fabrication of an implant supported temporary denture with TempBase Cap, immediately after implant installation.

### Two-stage surgical protocol

- Index impression with TempBase Cap immediately after implant surgery.
- Fabrication of an accurately fitting temporary denture in the laboratory, for delivery immediately after implant exposure.



Temporary restoration



Implant installation and index registration

## Chairside procedure

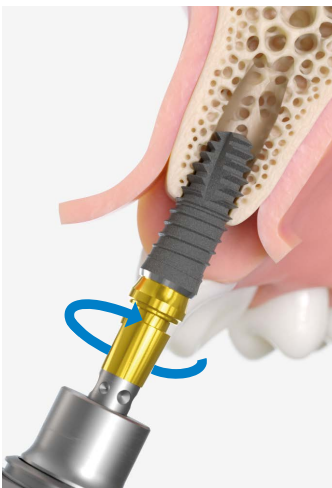

TempBase as placement head for implants



TempBase for index impression

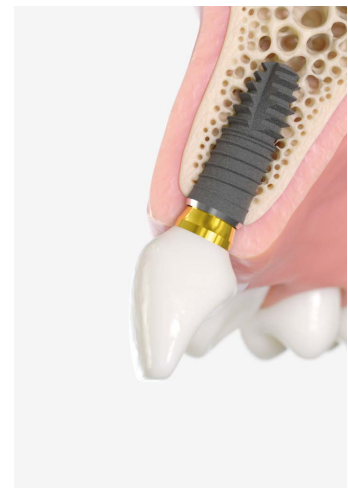

TempBase as basis for temporary restorations

For detailed information on prosthetic workflow, please see the DS Implants EV Prosthetics manual.

## Bone-specific preparation protocol

The bone quality in the maxilla and the mandible vary greatly depending on the area of the jaw. By varying the preparation of the crestal section of the implant site depending on the bone quality in combination with the condensing implant design, the implant achieves tangible primary stability in all bone qualities. Atraumatic and gentle preparation in hard bone of density D I, also stable and secure in soft bone of density D IV.

According to Misch<sup>1</sup>, Lekholm and Zarb<sup>2</sup>, bone of various qualities can be classified into four classes D I – D IV.

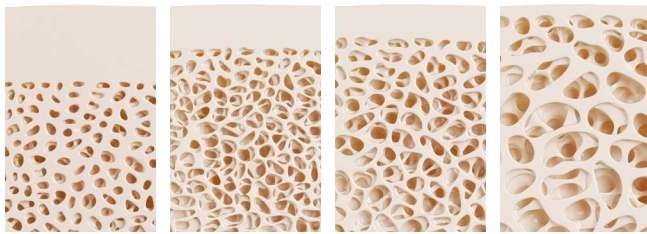

<b>Bone class D I</b> Dense cortical bone, almost no spongy bone.	<b>Bone class D II</b> Dense cortical bone, large- grain spongy bone.	<b>Bone class D III</b> Thin cortical bone, fine- meshed spongy bone.	<b>Bone class D IV</b> No cortical bone, fine spongy bone.
--	---	---	---

### Site preparation depending on bone quality

Once the site has the required implant diameter, the next step is generally crestal preparation to adapt the bone to the clinical situation. The drilling depth varies depending on the bone density, and in harder bone quality the tap is also used. This preparation is always required when cortical bone is present. The preparation of the implant site to adapt it to the bone density ensures ideal conditions for not loading the cortical bone during placement of DS OmniTaper implant.

### Condensing implant design

The special design of DS OmniTaper implant condenses the peri-implant bone during implant installation in cancellous bone without requiring the assistance of additional instruments. This principle of internal condensation achieves tangible primary stability meaning that the implant is securely fixed even in very soft or reduced bone quality.

### Atraumatic implant installation

Implant installation in cortical bone is safe and atraumatic with the apically self-tapping DS OmniTaper implant thread. Tapping the crestal implant site during implant installation with this thread prevents stress and overheating, particularly in the physiologically less reactive cortical bone.

#### References:

- Misch CE: Density of bone: Effect on treatment plans, surgical approach, healing, and progressive bone loading. *Int J Oral Implantol* 1990; 6 (2): 23-31
- Lekholm U, Zarb GA: Patient selection and preparation. In: Brånemark PI, Zarb GA, Albrektsson T (eds): *Tissue-integrated prostheses. Osseointegration in clinical dentistry.* Quintessence, Chicago 1985: 199-209

## 2. Treatment planning

Pre-operative planning should be based on the expected restorative treatment outcome. Therefore treatment planning should include all stages of the procedure, from healing time and components to temporary and final restorations.

The treatment planning is based on a comprehensive consultation with the patient, to determine exactly what the patient wants and expects from the treatment, but also to discover any possible contraindications and to explain the treatment in detail to the patient.

It is followed by a complete general and specific medical history and intraoral examination with analysis of the initial anatomical situation.

The following points must be considered:

- Medical and dental history
- General diagnoses – exclusion of contraindications
- Specialist consultation for risk factors
- Detailed intraoral examination including general radiographic examination.

After examination and evaluation of the diagnostic documentation, the treatment plan should be prepared.

Even though the final treatment approach may be determined at the time of surgery, consider the following based on the quality of supporting bone and expected initial stability of the implant(s):

- One- or two-stage surgical procedure
- Immediate or early loading protocol
- Expected healing time before loading.

When determining time to loading of implants for each individual case, the following should be carefully examined and assessed:

- Bone quality and quantity
- Primary stability
- Design of restoration
- Loading conditions

Before treatment begins, the patient should be informed about the results of the pre-operative examination and given a clear explanation of what the planned treatment entails, including the expected outcome, maintenance requirements and risks involved.

Accurate planning of every implant procedure is essential for the long-term success of the treatment. The planning process defines all actions and lists alternatives that can meet the patient's expectations of the function and esthetics of the implant-prosthetic rehabilitation.

---

### Conventional treatment planning

A diagnostic wax-up with the missing teeth replaced provides important information in the planning phase.

Based on analysis and evaluation of the occlusal table, force distribution and preferred sites for the implants, an optimal plan can be achieved.

The diagnostic wax-up and radiographs make it possible to plan implant position, angulation and size in order to support the planned prosthetic construction in an optimal way.

A surgical guide can be manufactured and used during surgery to aid the implant installation.

### Computer-guided treatment planning

Digital treatment planning based on three-dimensional imaging procedures enables the therapy to be planned with accuracy and makes the implant installation procedure predictable and precise.

Guided Surgery from DS Implants offers a complete solution for digital treatment planning with Simplant software and guided implant installation with the Simplant SAFE Guide.



## Clinical applications

The implants are intended for both one- and two-stage surgical procedures in the following situations and with the following clinical protocols:

- Replacing missing teeth in single or multiple unit applications in the mandible or maxilla.
- Immediate placement in extraction sites and in situations with a partially or completely healed alveolar ridge.
- Immediate and early loading for all indications, except in single tooth situations on implants shorter than 8mm or in soft bone (D IV) where implant stability may be difficult to obtain and immediate loading may not be appropriate.
- The intended use for OmniTaper EV implant Ø3.0 is limited to replacement of maxillary lateral incisors and mandibular incisors.

## Torque guide

### Recommended installation and tightening torque

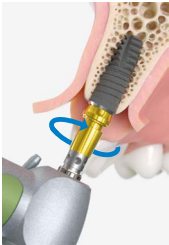
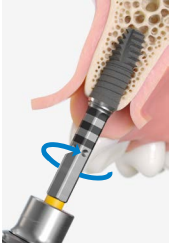
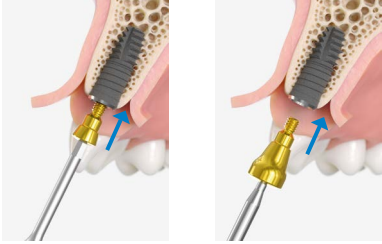
Type of product installation	Torque - Ncm	
<ul style="list-style-type: none"> <li>■ Implant installation with TempBase EV</li> </ul>		<p>Maximum 50 Ncm</p>
<ul style="list-style-type: none"> <li>■ Implant installation using the internal geometry</li> </ul>		<p>Maximum 70 Ncm</p>
<ul style="list-style-type: none"> <li>■ Cover screws EV</li> <li>■ Healing components EV</li> </ul>		<p>5 - 10 Ncm Manual/ light finger force</p>

# 3. Instruments

## Drills

The implant site is prepared in accordance with the bone class to simplify a safe implant installation in all bone qualities.

### OmniTaper Drill

For implant site preparation up to the planned implant diameter.

- Color coded and depth marked
- Multiple use
- Available in two lengths:
  - short: for the posterior region
  - long: for the anterior region

Drill short 8-15mm  
 Drill long 8-18mm

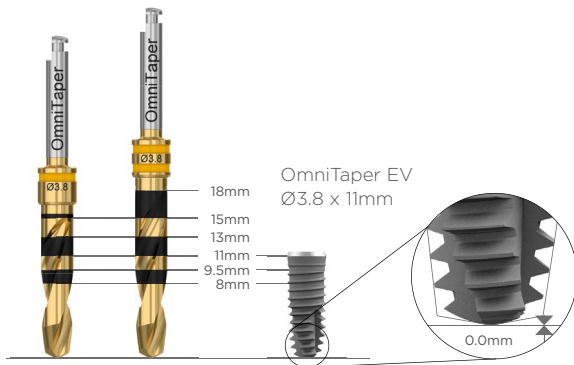

Ø	2.0	3.0	3.4	3.8	4.5	5.5
Color coding						

The effective drill depth matches the implant length.

### OmniTaper Drill SP

For implant site preparation up to the planned implant diameter.

- Color coded and depth marked
- Single use (SP=single patient)
- Available in short:
  - for implant lengths up to 15 mm



## OmniTaper Crestal Drill

For crestal implant site preparation according to the bone quality once the planned implant diameter has been reached.

- The degree of primary stability is achieved by the preparation depth of the crestal region of the osteotomy with the help of the crestal drill and in combination with the thread design of the OmniTaper implant.
- Cutting edge length maximum 6mm
- Non-cutting apical guiding section of 2mm
- Expansion of the crestal section of the cavity by approx. 0.2 mm
- Color coded and depth marked

Final preparation is accomplished with a crestal drill. The depth is dependent on the bone quality/density:

- 6mm preparation in type D I bone
- 2mm preparation in type D IV bone
- The crestal drill must generally be used. The only exception is missing cortical bone.

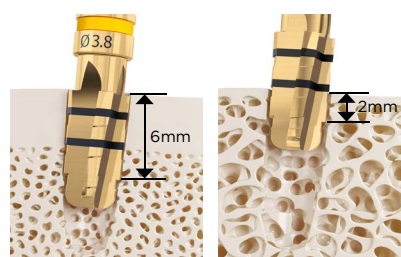
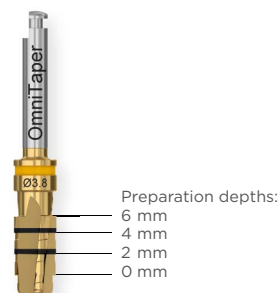

The depth of crestal preparation in D I to D III bone is up to 6mm.

The depth of crestal preparation in D IV bone is 2mm.

For 8mm implants, 4mm is the maximum depth for crestal preparation.

The crestal drill should generally be the last drill used for preparation. In very dense bone the tap must be used after the crestal drill has been used to the maximum possible depth (6mm).

## Guide Drill

Used for marking and to create a starting point.



### OmniTaper Tap

For additional tapping in cortical bone (D I).

- The working section is no longer visible at a preparation depth of 6mm.
- Color coded

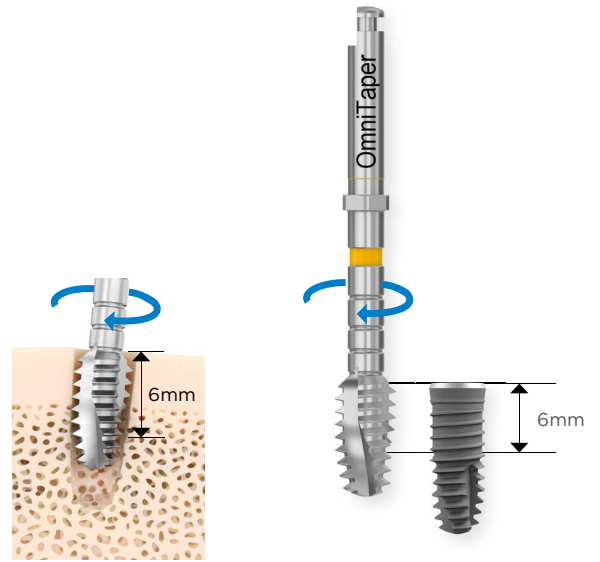

Bone class D I

### Try-in Implant

#### OmniTaper Try-in Implant

For intra-operative check of implant position, implant axis, congruency between implant and bone crest and peri-implant soft-tissue level.

- Design matches the DS OmniTaper implant
- Measure the thickness of the soft tissue
- Applicable for all implant lengths
- Color coded

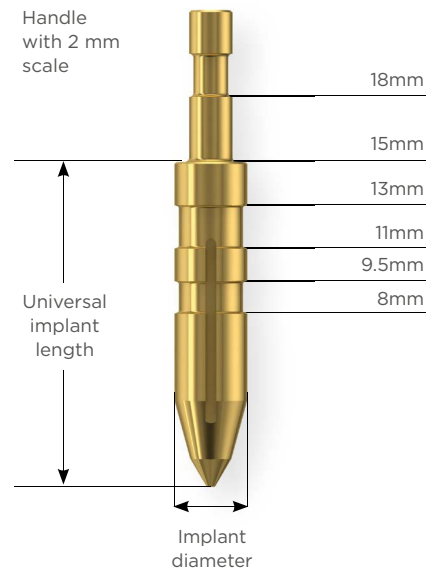

## Implant Driver

The DS OmniTaper implant is usually installed with the pre-mounted TempBase EV, which acts as implant holder and placement head. The implant driver can be used with the contra-angle handpiece or with the torque wrench.

### Implant Driver TempBase

For installing DS OmniTaper implant with the TempBase EV (standard procedure).

- Dimple to facilitate correct positioning
- Applicable for all implant diameter
- Available in short and long

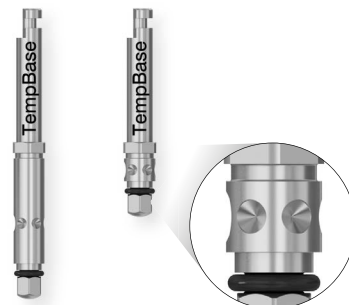

### Implant Driver EV

For installing the implant without using the TempBase EV.

- Color coded and depth marked
- Available in short and long

Ø	3.0	3.4	3.8	4.5	5.5
Color coding	Green	Purple	Yellow	Blue	Brown

## Torque Wrench

### Torque Wrench EV

For implant installation and adjustment of implant position.

- Used together with the surgical driver handle.



### Torque Wrench EV Surgical Driver Handle

## Hex Driver

For tightening screws of surgical and restorative components.

Hex Driver Type	For contra-angle handpiece, surgical driver handle or restorative driver handle			Manual	

## Surgical Tray

All instruments for surgical use are stored in the OmniTaper Surgical Tray, which is designed to make all instruments easily accessible, easy to clean and sterilize. The instruments are arranged in order of usage. For preparation with guided surgery a separate surgical tray is available.

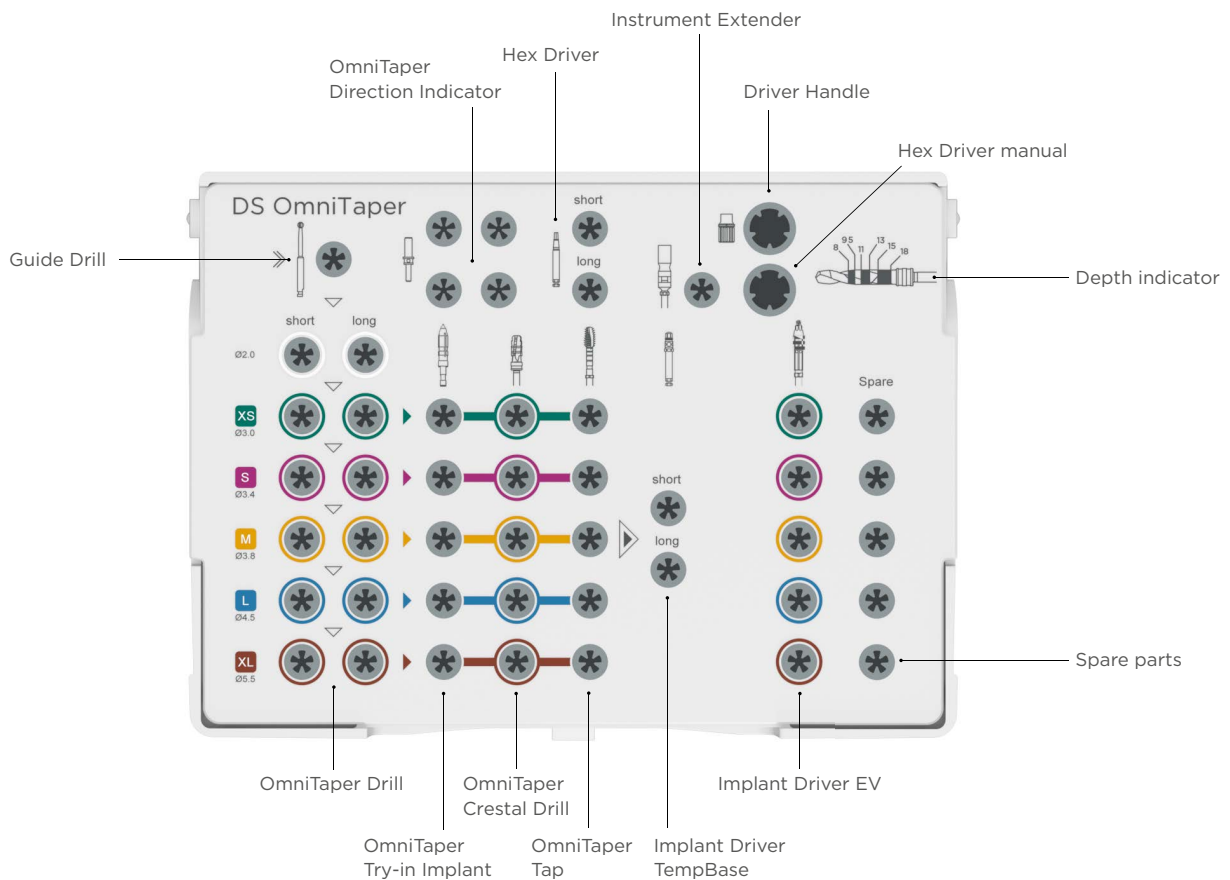

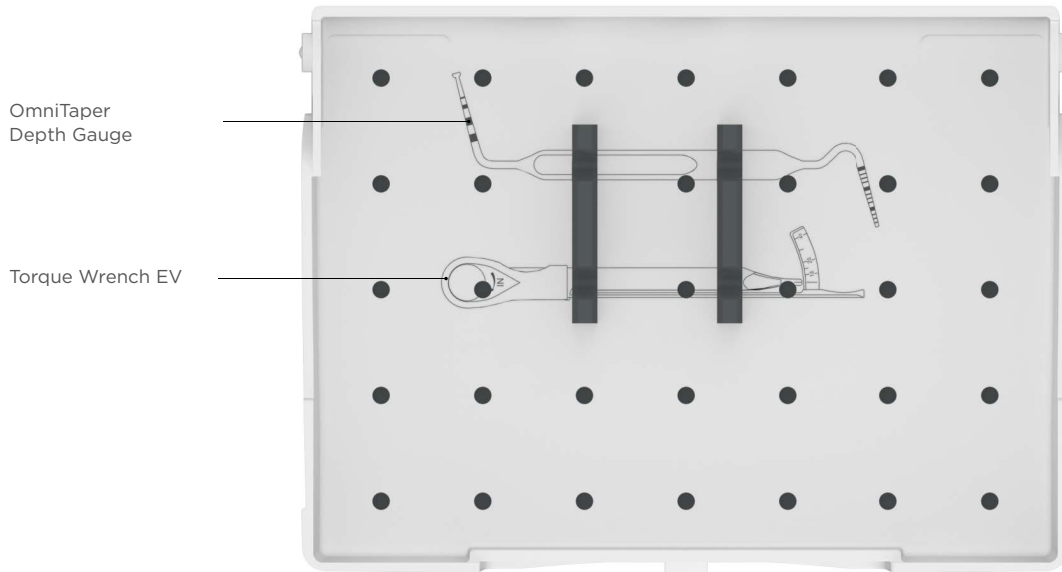

Two different opening positions, for easy removal of instruments and user-friendly handling.



QR code for additional information about the surgical tray.



## 4. Implant site preparation

The DS OmniTaper implant design enables high stability and even distribution of forces. These characteristics protect important neighboring anatomical structures. During the planning phase it is important to check that the horizontal and vertical bone volume is sufficient for installation of an implant.



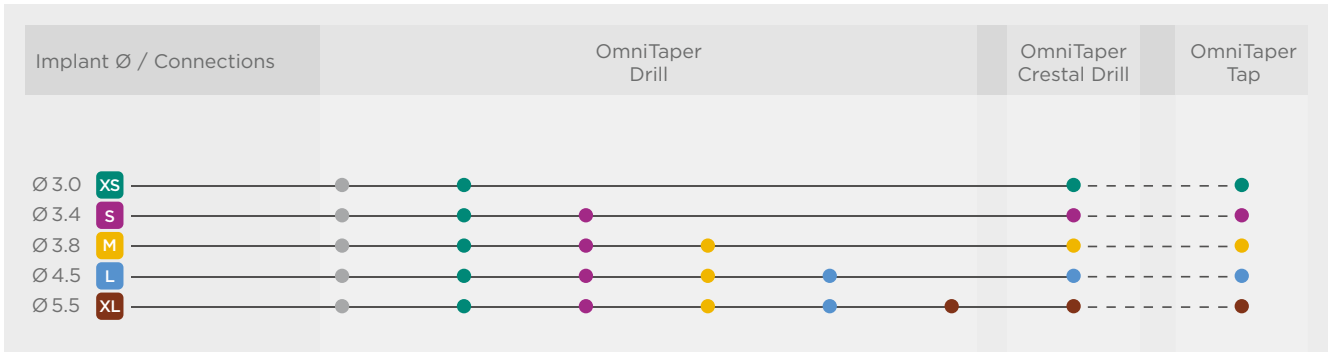





### Drill sequence



- The Guide Drill is used for marking and to create a starting point.
- In case of dense cortical bone (type D I), the OmniTaper Tap must be used.

### Procedure

Implant site preparation, e.g. for OmniTaper EV Ø3.8 x 11mm, dense bone (D I).

Marking	Pilot drilling	Expansion drilling			In-process control	Crestal preparation	Tapping	Implant installation
Guide Drill	OmniTaper Drill Ø2.0 short	OmniTaper Drill Ø3.0 short	OmniTaper Drill Ø3.4 short	OmniTaper Drill Ø3.8 short	OmniTaper Try-in Implant Ø3.8	OmniTaper Crestal Drill Ø3.8	OmniTaper Tap Ø3.8	Implant Driver TempBase short
								
	max. 1500 rpm					max. 1500 rpm	15 rpm	



## Procedure

The following images show the implant site preparation for an OmniTaper EV Ø3.8 x 11mm.



### Incision direction

- Expose the bone by performing an appropriate incision.
- Mobilize and fold back the mucoperiosteal flap.



### Marking

- Use the Guide Drill to mark the implant position.



### Blister

- Open the package and place the blister onto a sterile area.
- Secure the drill by squeezing the blister.



### Blister

- Expose the drill shaft by bending back the top of the blister.

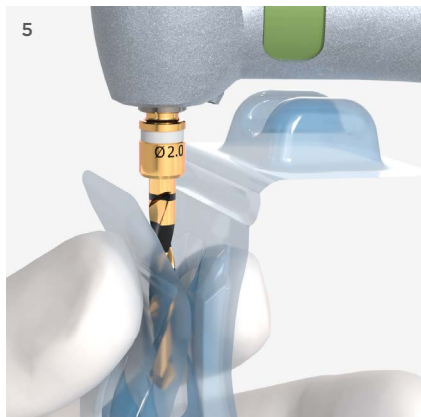

### Pick-up

- Engage the drill with the contra-angle handpiece.

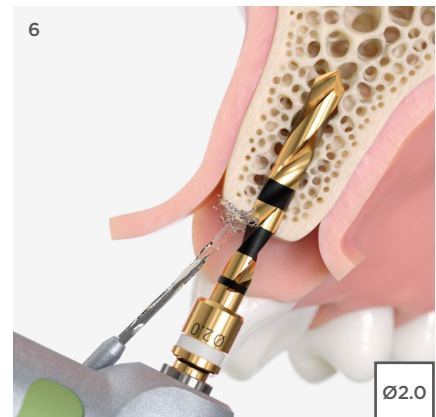

### Pilot drilling

- Drill the pilot hole with the OmniTaper Drill Ø2.0.

Cutting instruments should generally be replaced after 10 cycles of use. Blunt or damaged instruments must be replaced immediately. Gentle, thorough disinfection and cleaning of the drills will ensure that they operate at their best. Please observe the instructions for Sterilization and Instrument Care.

To avoid over-heating, drill to maximum of 1500 rpm.

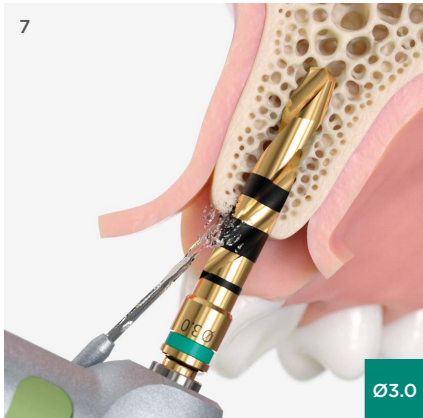

#### Expansion drilling Ø3.0

- Drill the first expansion with the OmniTaper Drill Ø3.0.

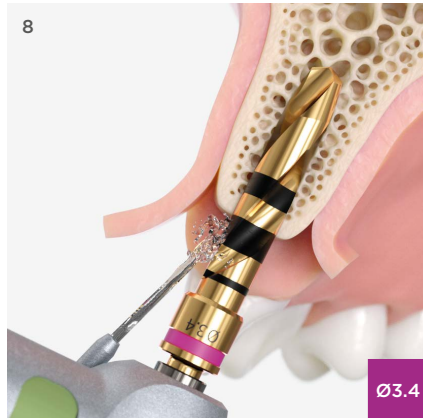

#### Expansion drilling Ø3.4

- Prepare the implant site in ascending order by using drills with increasing diameters.

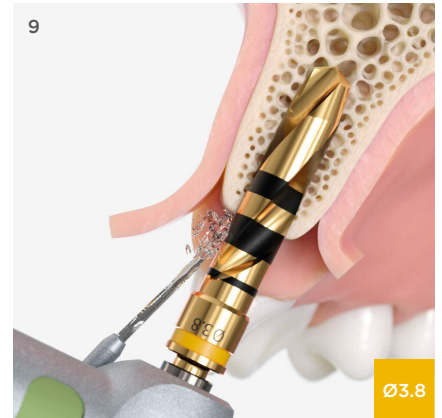

#### Final drilling Ø3.8

- Use the drill that matches the diameter of the planned implant for the final drilling.

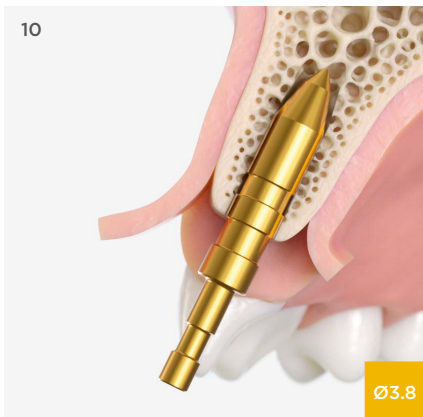

#### In-process control

- Check with the OmniTaper Try-in Implant that depth and orientation in the osteotomy are correct.
- Adjust the osteotomy if required.

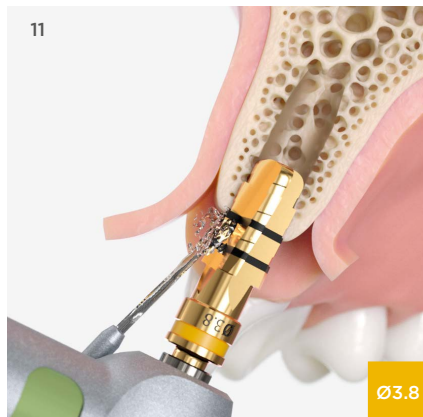

#### Crestal preparation of the bone

- Prepare the osteotomy with the OmniTaper Crestal Drill Ø3.8 as required by the clinical situation and the bone class.

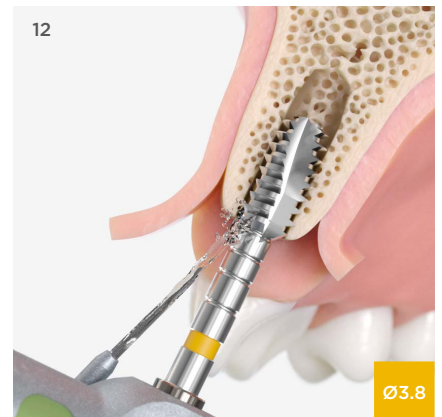

#### Additional tapping in dense cortical (D I) bone

- Prepare the site with the OmniTaper Tap Ø3.8 at maximum 15 rpm until the head of the instrument with the thread is no longer visible (6mm depth).
- Turn the tap counterclockwise to remove it from the osteotomy.

The OmniTaper Crestal Drill is generally required for vertical extension of the crestal implant site. Even at its maximum extension a tangible primary stability encourages healing.

## 5. Implant packaging

DS OmniTaper implants are supplied in a double-blister package with an outer carton.



### Outer box

- Specific color coding, diameter and prominent implant length information on side labels.
- Data matrix code accessible on two sides.
- Stackable, all important product information remains visible.
- Instructions For Use (IFU) available electronically (eIFU): [ifu.dentsplysirona.com](http://ifu.dentsplysirona.com)



### Outer blister

- Open the implant package outside the sterile area.
- Remove the sealing foil of the outer blister.



### Inner blister

- Inner sterile package.
- Contains implant shuttle with implant and cover screw.
- Peel-off label with batch code supporting a convenient documentation of treatment.

## 6. Implant installation

### Standard procedure

DS OmniTaper implants placed with the TempBase using the standard protocol.

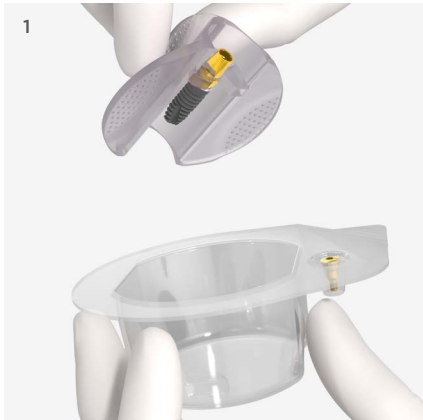

#### Implant shuttle

- Holds the implant with the TempBase securely in the packaging and protects it from damage.

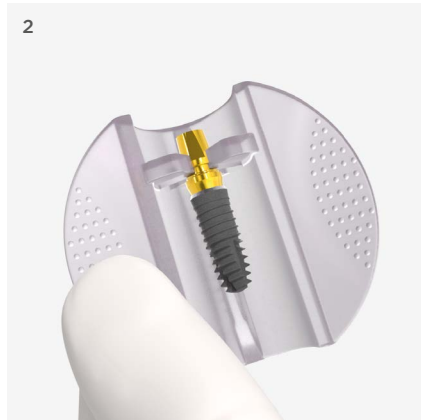

- Three wings with roughened surfaces for non-slip holding simplify safe handling.

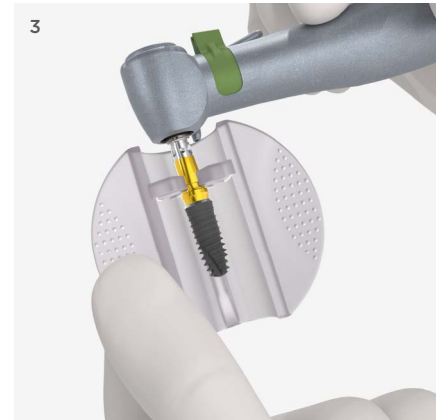

#### Placing the implant driver

- Pick up the TempBase with the Implant Driver TempBase.

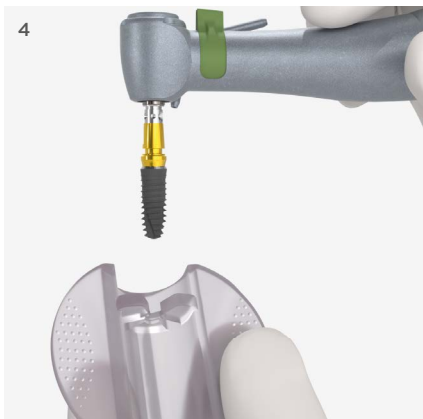

#### Pick-up the implant

- Lightly bend the wings of the implant holder to pick up the implant without contamination.

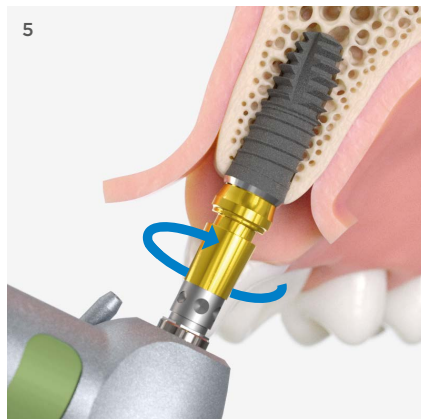

#### Placing the implant via TempBase

- Use the Implant Driver TempBase to install the implant into the osteotomy at 15 rpm and at a maximum of 50 Ncm.
- One dot on the implant driver must point in the vestibular direction in the end position.

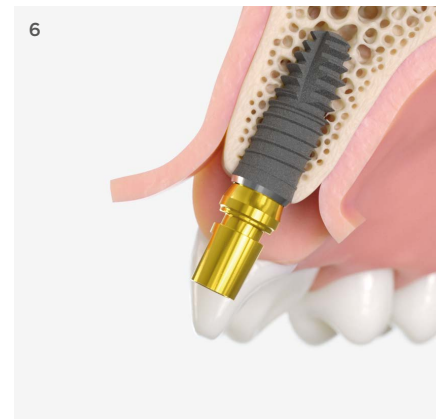

- After placement the polished implant neck must be supracrestal.
- Irregularities in the vertical bone height can be compensated by the placement depth.

Keep the inner blister horizontal when opening and keep it after removal of the implant holder; it contains the cover screw of the implant, which is mounted after implant installation for submerged healing.

If the torque reaches 50 Ncm during seating, then proceed as described on the next page.

### Optional: Placement of OmniTaper with the implant internal geometry

If torques above 50 Ncm are encountered during placement of implants using the TempBase, the process must be stopped and the TempBase must be removed from the implant. The implant is brought to its final position using the internal connection in combination with the appropriate implant driver. After implant installation, the TempBase EV is resealed into the implant to fabricate a temporary restoration or for index registration.

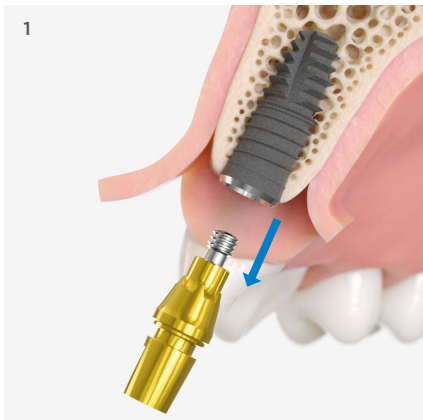

#### Removing the TempBase

- Remove the TempBase by loosening the screw with the Hex Driver.
- Clean and rinse the internal implant geometry.

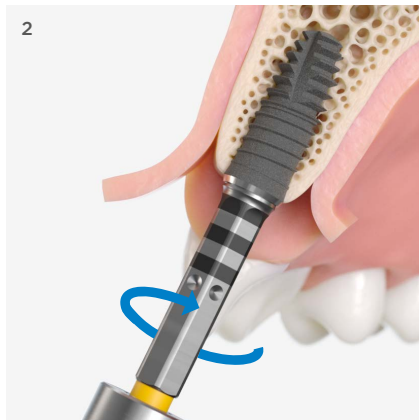

#### Placing the implant using the internal geometry

- Use the Torque Wrench together with the Implant Driver EV (M) to install the implant into the prepared site.
- Position one of the dots on the implant driver vestibular to facilitate optimal placement of pre-designed abutments.

Do not exceed 70 Ncm installation torque to avoid damaging the implant connection.

## One-stage surgical protocol procedure

If a one-stage procedure with transgingival healing is planned without preparation of an implant-supported temporary denture, the implants can be covered with healing abutments. This is an option where an existing denture can be used as a temporary restoration.

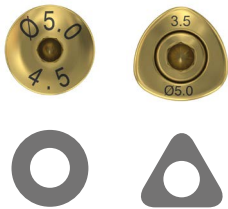

### HealDesign

- Round shapes are indicated for all positions in the mouth
- Triangular design for anterior implant sites to mimic the shape of incisors and canines
- Marked with diameter and height
- Color coded

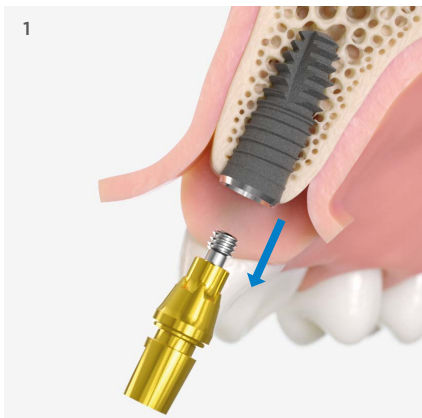

### Removing the TempBase

- Remove the TempBase by loosening the screw with the Hex Driver.
- Clean and rinse the internal implant geometry.

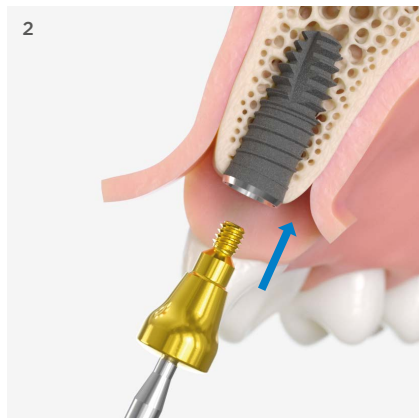

### Placing the healing abutment

- Manually secure the healing abutment using light finger force (5-10 Ncm).



### Suturing

- Adapt and suture the soft tissue.

An existing temporary denture, such as a clasp denture or a bridge fixed to neighboring teeth, is ground to ensure that there will be no pressure on the healing abutment.



## Two-stage surgical protocol procedure

If a two-stage procedure is planned, the implant is sealed with a cover screw during the healing phase to prevent the entry of saliva and bacteria. The color-coded cover screw is fixed in the inner blister.

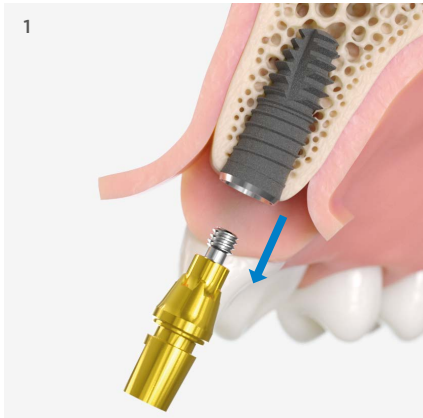

### Removing the TempBase

- Remove the TempBase by loosening the screw with the Hex Driver.
- Clean and rinse the internal implant geometry.

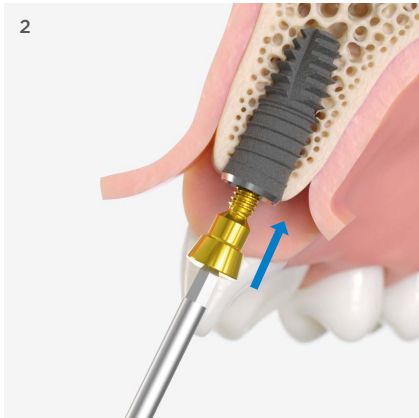

### Placement of the Cover Screw

- Insert the Cover Screw using the Hex Driver.
- Tighten with light finger force (5-10 Ncm).

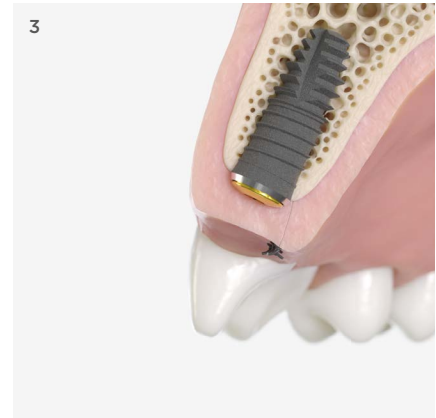

### Suturing

- Reposition and fix the tissue flaps with sutures.

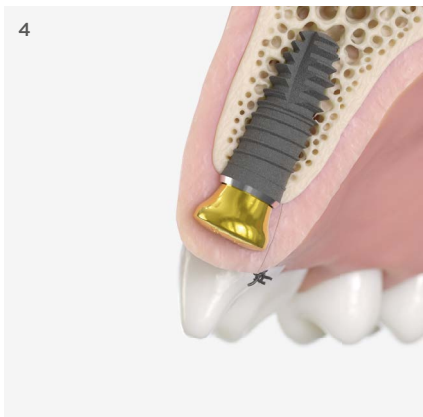

### Option: HealDesign EV (M) 2.5 mm

- Use a healing abutment instead of the cover screw to extend the soft tissue for soft-tissue repositioning during the healing phase.

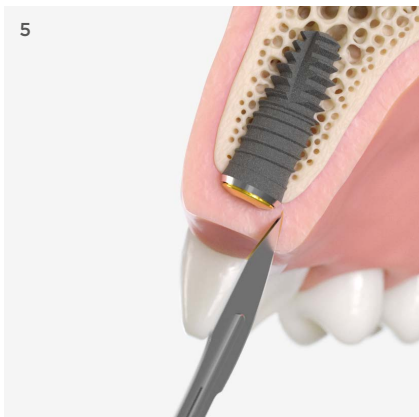

### Exposure

- After the osseointegration phase expose the implant for fabrication of the prosthetic restoration.
- Depending on the planned procedure, place a healing abutment or a temporary denture.

## 7. Index registration

### TempBase index registration procedure

The index registration is done before suturing the flaps. The temporary denture is fabricated in the laboratory during the healing phase.



#### Placing the TempBase Cap

- Leave the TempBase on the implant or, if necessary, reinsert it for the index registration.
- After removing the lateral tab, place the TempBase Cap on the TempBase until it snaps into position and is securely seated.

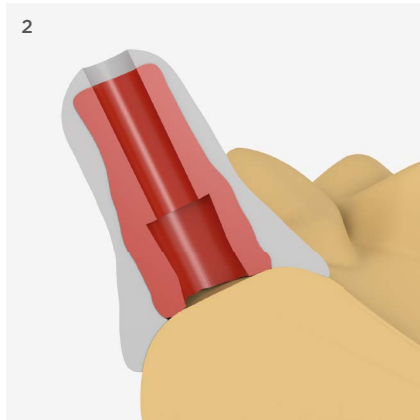

#### Stent

- The index registration is ideally done with a drill template fabricated before the operation on a situation model.



#### Check the correct fit

- Fixate the surgical stent on the TempBase Cap and check the correct fit.

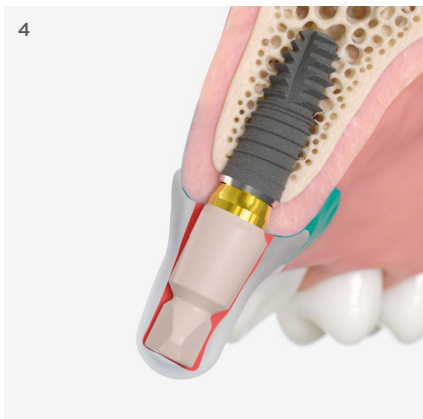

#### Impression taking

- Fill the template with a polymer placed on the TempBase Cap and polymerize.
- Place a rubber dam in the oral cavity before using the polymers to prevent irritation of the mucosa or an allergic reaction.

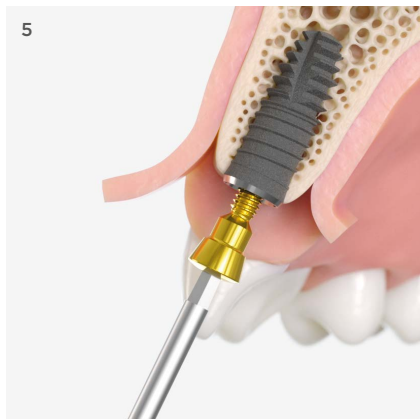

#### Placing the Cover Screw

- Place the Cover Screw using the Hex Driver Manual
- Tighten with light finger force (5-10 Ncm).



#### Suturing

- Suture the tissue to prevent the ingress of bacteria and saliva.
- Send the impression and the TempBase to the laboratory for further processing.

Before using polymers please see the instructions in the manufacturer's user manual.



During the healing period, the laboratory fabricates an individual restoration which can be placed in the patient's mouth immediately after exposure of the implants.

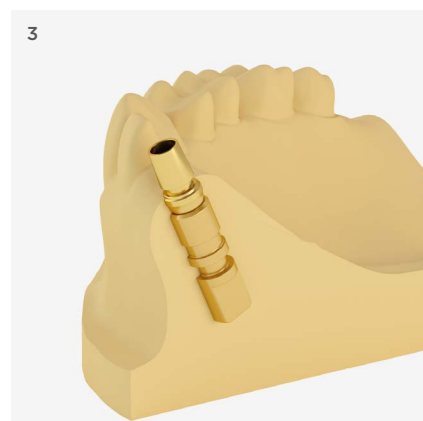
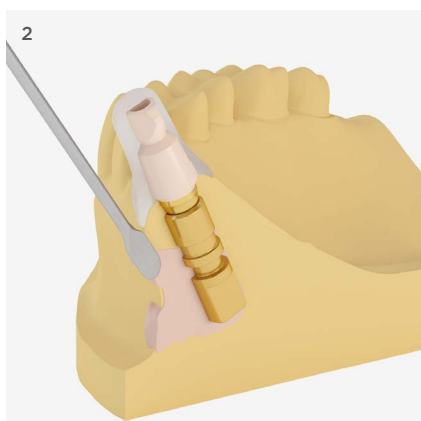

### Fabrication of the master cast in the dental laboratory

- Connect an Implant Analog to the TempBase.
- Insert the TempBase, together with the Implant Analog, into the TempBase Cap which is attached to the template.
- The original master cast is modified in order to make room for the analog.
- Place the template with the analog on the master cast.
- Attach the analog to the master cast with plaster.
- The analog now has the same position in the master cast as the implant in the patient's mouth.
- During the healing period the laboratory fabricates a temporary restoration which can be placed in the patient's mouth immediately after exposure of the implant.

## 8. Guided Surgery

### Computer-guided 3D planning and implant installation

The implant installation procedure is planned in 3D with the Simplant software. It provides a complete image of the patient's anatomy for selection and placement of implants and abutments.

With the Simplant SAFE Guide (manufactured by Dentsply Sirona or 3D printed in the clinic using the Simplant Guide File) or manufactured in the clinic using the Simplant Guide File as well as with the CEREC Guide (chairside manufacturing) you can work with fully guided procedure. This means that all surgical steps from soft-tissue punch to implant installation can be performed with the guide in place.

#### Surgical simplicity





Using a Simplant Guide with DS OmniTaper makes the process precise and safe.

- The “Sleeve-on-Drill” system simplifies handling and replaces the drill key which saves you an assisting hand.
- The guided surgery instrumentation is based on either absolute drill stops or depth markings.
- The optional lateral access of the Simplant SAFE Guide facilitates the handling even for cases with limited inter-occlusal space.
- When aligning the markings on the implant driver with the patient-specific marking on the Simplant Guide, it is easy to seat prosthetic components or premanufactured, patient-specific restorations.

#### Color coding

The color coding makes it easy to identify the right connection, diameter and to select the right prosthetic components.

#### DS OmniTaper implants for use with Guided Surgery:

Implant Ø	3.0mm	3.4mm	3.8mm	4.5mm
Connections				
Lengths	-	-	8mm	8mm
	-	9.5mm	9.5mm	9.5mm
	11mm	11mm	11mm	11mm
	13mm	13mm	13mm	13mm
	15mm	15mm	15mm	15mm

## 9. Instruments Guided Surgery

Specific instruments are available for guided surgery with DS OmniTaper implants. These are marked “GS” (Guided Surgery) and can only be used together with the Simplant SAFE Guide and CEREC Guide 3. When using Simplant software or Simplant planning service, case-specific guided surgery instruments can be ordered with the Simplant SAFE Guide.

### Mucosal Punch

#### OmniTaper Mucosal Punch GS

For minimally-invasive exposure of the surgical site.

- Guided directly in the guide



### Drills

#### OmniTaper Initial Drill GS

For removal of soft-tissue residue after use of the mucosal punch.

- For creating a starting point for the following drills (specific to the implant diameter)
- Guided directly in the guide



#### Sleeve-on-Drill system

Drill sleeves to be attached to the drill.

- When using the guide, a simple and precise guiding of the drill is guaranteed.
- The drill stop system ensures exact depth control.

#### OmniTaper Drill GS

For implant site preparation up to the planned implant diameter.

- Guided with the Sleeve-on-Drill system

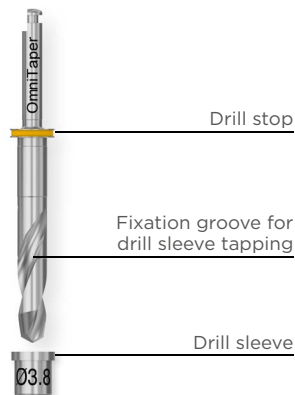

OmniTaper Drill GS is used to maximum of 800 rpm.

#### OmniTaper Drill Sleeve for Drill GS

For safe guidance of the drills in the surgical guide.

- Narrow sleeve (ND) for Ø3.0 - Ø3.8 implants
- Wide sleeve (WD) for Ø4.5 implants
- Single use



The drill sleeves are for single use only and must be removed from the drill immediately after use.

### OmniTaper Crestal Drill GS

For crestal implant site preparation according to the bone quality once the planned implant diameter has been reached.

- Guided directly in the guide
- Mechanical depth stop
- Depth marked



Drills, Crestal drill and Tap for guided surgery can only be used with the contra-angle handpiece.

### OmniTaper Tap GS

For pre-tapping of the implant threads in cortical bone (D I).

- Guided directly in the guide
- Depth marked (No mechanical depth stop)

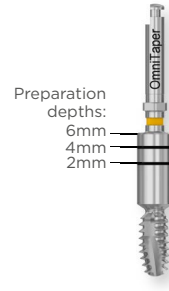

OmniTaper Tap GS is used to maximum 15 rpm at maximum 50 Ncm.

## Implant Driver

### OmniTaper Implant Driver TempBase

For placing OmniTaper implants with the TempBase using a contra-angle handpiece or the Torque Wrench.

- Markings on the shaft to align the abutment position and to monitor the rotational speed
- Driver sleeve is detachable and screwed on the implant driver; replacement sleeves are available
- Narrow diameter (ND) for Ø3.0 - Ø3.8 implants
- Wide diameter (WD) for Ø4.5 implants
- Torque: ≤ 50 Ncm
- Available in short and long



## Stabilization Abutment

### OmniTaper Stabilization Abutment GS

Prevents lateral movement of the surgical guide between the preparation of different implant sites and the second stabilization abutment GS. It also prevents the distortion of the guide.

- Narrow diameter (ND) for Ø3.0 - Ø3.8 implants
- Wide diameter (WD) for Ø4.5 implants



## Positioning Aid

### OmniTaper Positioning Aid EV GS

Used to secure implant analogs in the surgical guide in order to transfer the implant position, planned virtually, to a laboratory model (e.g. master cast, plaster cast).



## Surgical Tray Guided Surgery

All instruments for surgical use are stored in the OmniTaper Surgical Tray GS, which is designed to make instruments easily accessible, easy to clean and sterilize. The instruments are arranged in order of usage.

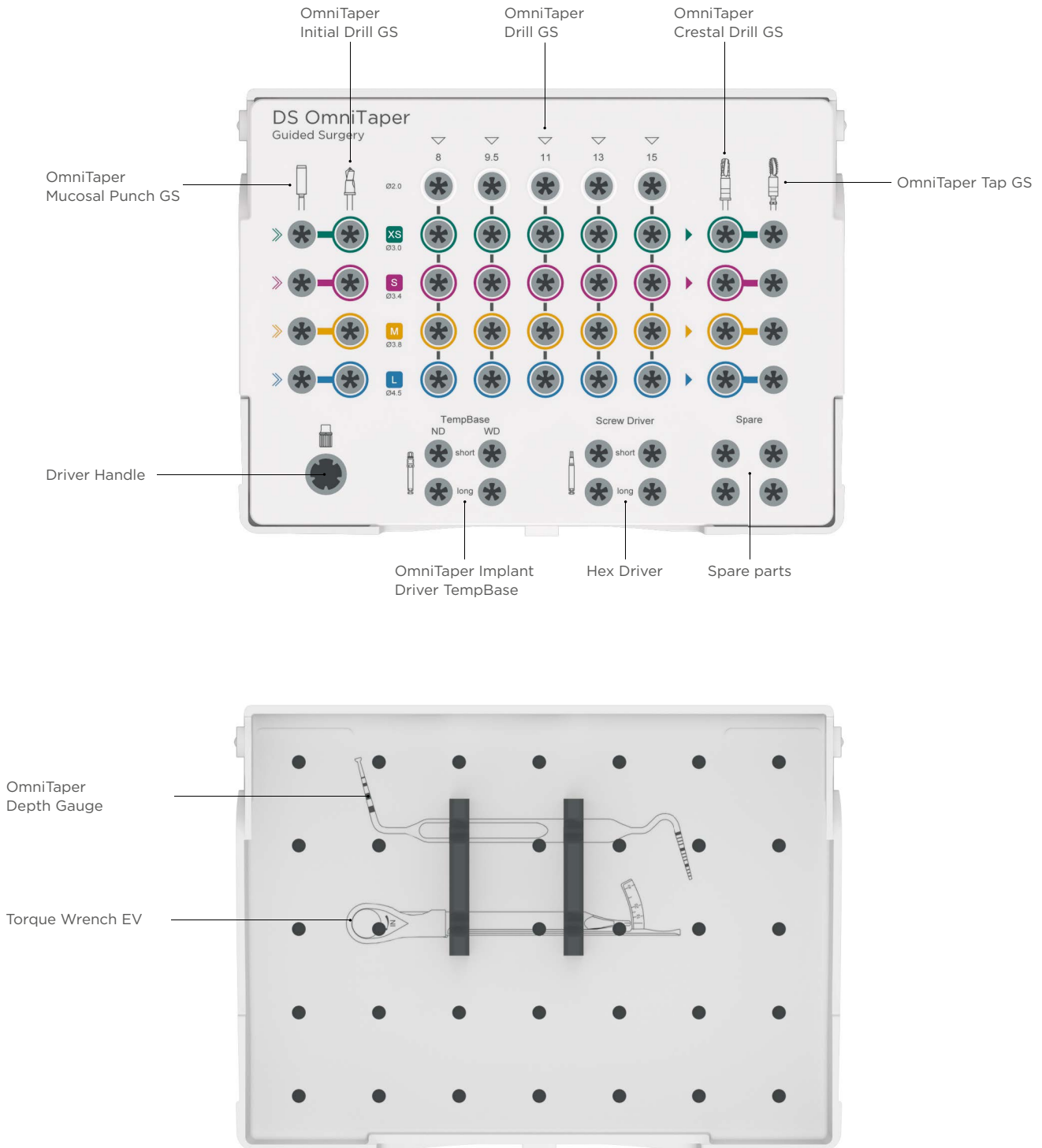

## 10. Siplant SAFE Guide

A custom-made Siplant SAFE Guide is fabricated from the patient's digital planning data using additive manufacturing with medical grade resin (stereolithography technique).

This guarantees the exact and precise transfer of the planning into the patient's mouth.

### Types of support

#### **Tooth-supported Siplant Guide**

- For single tooth and partially edentulous cases when minimally invasive surgery is preferred
- Centrally printed by Dentsply Sirona in medical grade resin or delivered as Siplant Guide File with Siplant Guide Sleeves for local manufacturing
- To provide the prosthetic information, dentition scan (intra oral or lab scan) is required. Also, desired tooth setup and/or antagonist scan is recommended

#### **Mucosa-supported Siplant Guide**

- For fully edentulous cases when minimally invasive surgery is preferred
- Centrally printed by Dentsply Sirona in medical grade resin, or delivered as Siplant Guide File with Siplant Guide Sleeves for local manufacturing
- (CB) CT Scan prosthesis required

#### **Bone-supported Siplant Guide**

- For larger partially or fully edentulous cases
- Positioned on the jawbone after raising mucoperiosteal flaps
- Centrally printed by Dentsply Sirona in medical grade resin
- To provide the prosthetic information, a (CB) CT Scan prosthesis is recommended

## Tooth-supported procedure

A tooth-supported surgical guide can be used either with a flapless technique or by raising a flap.



When placing multiple implants in a situation with a low number of remaining teeth or unfavorable structure of existing teeth, tooth-supported guides must also be stabilized with stabilization abutments. In such cases at least the first two implants must be prepared, inserted and provided with a stabilization abutment before drilling is carried out at other sites.

### Tooth-supported Simplant SAFE Guide

- Check the fitting of the guide on the master cast.
- Depending on the design of the guide, the criteria for bone- or mucosa-supported guides apply to the edentulous regions.
- Place the guide into the patient's mouth and check for a precise and stable fit.
- Small openings along the cutting edges and/or the tips of the cusps of the teeth will make checking easier.
- In case there are few remaining teeth or instability of the guide, it is fixed according to the procedure for bone- or mucosa-supported surgical guides.

## Bone-supported procedure

A bone-supported surgical guide is used for edentulous and partially edentulous patients with more than three missing teeth.

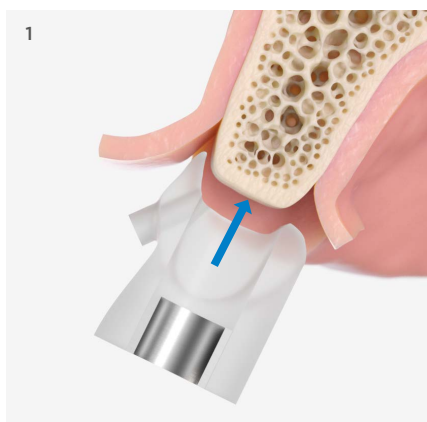

### Bone-supported Simplant SAFE Guide

- Check the fit and the extension of the guide base.
- To guarantee a definite and stable fit, the base should only be as large as necessary.
- Place the guide into the patient's mouth and check for a precise and stable fit.
- Make sure the guide maintains its position in the jaw.
- If necessary use guide fixation screws to fix the guide into the jaw.

Excessive force on the surgical guide, e.g. excessive tightening of the fixation screws (osteosynthesis screws), tilting of instruments and excessive pressure should be avoided particularly at the fixing points. This may cause breakage of the guide making it unusable. Only use fixation screws where the guide design includes guide sleeves for fixation.

## Mucosa-supported procedure

Mucosa-supported surgical guides guarantee a minimally invasive procedure and are generally utilized for edentulous patients.



### Mucosa-supported Simplant SAFE Guide

- Check the fitting of the guide on the master cast. This must be large enough to guarantee a stable fit.
- Place the guide in the patient's mouth and check for a precise and stable fit.
- A bite index made from plastic or registration silicone, fabricated beforehand in the articulator, guarantees that the surgical guide records the same position as the scanning template.
- Fix the surgical guide vestibularly in the designated positions.
- Carefully close the patient's mouth and allow biting into the index.
- Remove the bite index and, if required, use fixation screws palatally or lingually.

When placing multiple implants, mucosa-supported guides must be stabilized with stabilization abutments. At least the first two implants must be prepared, inserted and provided with a stabilization abutment before drilling is carried out at other sites. Hence, the surgical guide cannot be displaced or distorted between the further drilling processes.



# 11. Implant site preparation – Guided Surgery

The implant site, e.g. for an OmniTaper EV Ø3.8 x 11mm, is prepared for guided surgery by using the same steps as for conventional preparation. In the following, the transgingival procedure with tooth-supported guide is described. The mucosal punch is only required for flapless surgery.



## Mucosal punching

- Insert the OmniTaper Mucosal Punch GS of the planned implant diameter into the guide, while rotating, until it comes lightly in contact with the bone.

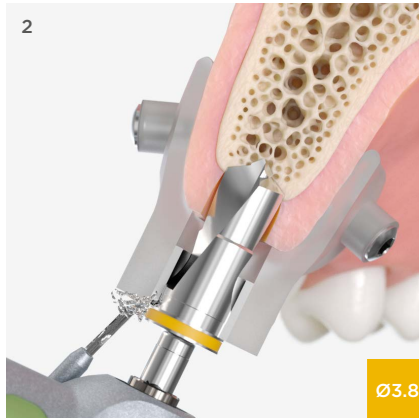

## Initial drilling

- Use the OmniTaper Initial Drill GS to remove the soft and hard tissue and to prepare the shape of the bone for the first full-length drill.
- If applicable, remove the previously punched mucosa.



## Pilot drilling

- Use the OmniTaper Drill GS Ø2.0 of the planned implant length to prepare the pilot hole.
- Lock the Sleeve-on-Drill sleeve in the first groove above the drill tip.
- Lower the drill sleeve into the guide sleeve of the surgical guide to the stop. Do not activate the rotation until this point.
- Drill rapidly but without excessive pressure until you reach the drill stop. The still rotating drill is only withdrawn to the original position after reaching the desired depth (no intermittent drilling).
- Stop drilling when reaching the depth position stop.
- Carefully move the drill back and forth, gently pull, until the Sleeve-on-Drill sleeve is released from the guide sleeve.

All drilling, except for the Punch, should be performed at a maximum speed of max. 800 rpm with profuse irrigation. Use the hole below the guide sleeve in the Simplant SAFE Guide for adequate cooling.

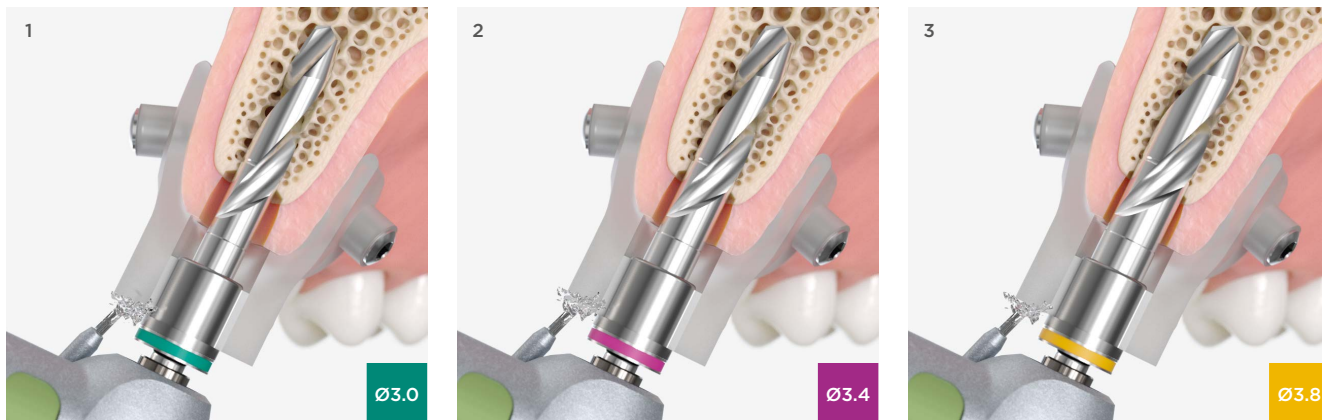

### Expansion drilling

- After the pilot drilling, the implant site is prepared to the planned implant diameter using OmniTaper Drills GS of the planned implant length in ascending order.

Cutting instruments should be replaced after 10 uses or if they are damaged or blunt. Drill sleeves for guided implant installation must be replaced after the surgical procedure as they are designed for single use only. If they are used more than once, anatomical structures may be injured.

After reaching the intended implant diameter, the cavity is prepared with the OmniTaper Crestal Drill GS as required by the clinical situation and the bone class. Subsequently, the thread for the implant is tapped in the crestal section of the implant site in cortical bone of class D I with the OmniTaper Tap GS.

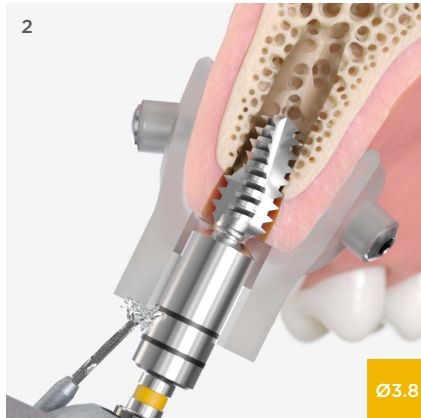
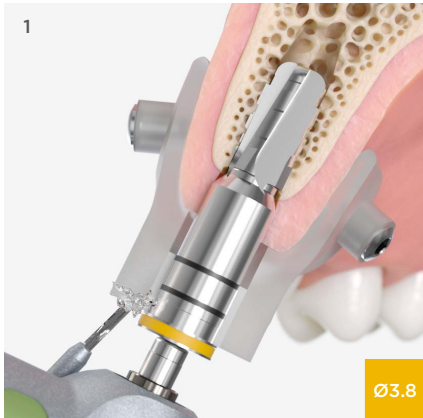

### Crestal bone preparation

- Use the OmniTaper Crestal Drill GS that matches the implant diameter to prepare the crestal region of the implant site.
- Crestal preparation of the osteotomy is accomplished with a crestal drill GS depending on the bone quality/density:  
6mm preparation in type D I bone  
2mm preparation in type D IV bone

### Tapping (additional)

- Use the OmniTaper Tap GS after crestal preparation in cortical bone of class D I.
- Insert the suitable diameter tap in the contra-angle handpiece.
- The maximum rotary speed is 15 rpm and the maximum torque is 50 Ncm.

- The tap is guided in the surgical guide.
- Unlike the drills previously used, the tap is not equipped with a depth stop.
- Once the upper part of the cylindrical shaft is in-plane with the top margin of the guide sleeve, the maximum preparation depth has reached.
- Remove the tap from the osteotomy in a counterclockwise direction.
- Rinse the osteotomy with physiologic saline.

Since the tap does not have a mechanical depth stop, the visual control of the maximum preparation depth must be observed. If the tap is screwed in too deeply, there is a risk of damaging anatomical structures and nerves.

## 12. Implant installation – Guided Surgery

The following images show the placement of an OmniTaper EV Ø3.8 x 11mm.



### Implant installation

- Use the OmniTaper Driver TempBase GS to place the implant at 15 rpm and maximum 50 Ncm.
- The planned implant position is reached when the cylindrical section of the implant driver is level with the guide sleeve.



### Implant installation Atlantis abutment

- The accurate position of the OmniTaper corresponds to the correct rotational position of a premanufactured patient-specific Atlantis abutment.
- Identify the index markings on the OmniTaper Driver TempBase GS. The correct position is reached when one of the index markings aligns with the index marking on the Siplant Guide.
- Alternatively, if it is hard to identify the index marking on the driver, make sure that one of the six flat sides of the drivers hexagon is aligned with the indexing mark on the Siplant Guide.



### Securing the surgical guide

- Prior to inserting further implants, the stabilization abutment is inserted into the TempBase and secures the guide to prevent it from moving and rotating between preparations of multiple implant sites.
- At least the first two implants must be prepared, placed and provided with a stabilization abutment in succession before further implants are placed.

Implants should be inserted in succession: prepare the first implant site, insert the implant, attach the surgical guide with stabilization abutment. Thereafter prepare the second implant site, etc. The second implant may only be prepared when the surgical guide has been attached after the insertion of the first implant.

If the implant is placed deeper than planned, there is the risk of damaging anatomical structures.







