

Ankylos<sup>®</sup>

# Prosthetic Manual



## General prosthetic advice for Ankylos®

In order to obtain utmost benefit from the unique restorative features of the Ankylos implant system, please observe the following guidelines:

- Avoid occlusal overload, aim for initial infra-occlusion to ensure clearance of contacts in function.
- If possible, use B-implants or larger for single molar restorations.
- Use gingiva height 0.75 and 1.5 only if really necessary, and in correspondence with thin gingiva.
- Minimize the functional occlusal surface in buccal-lingual dimension to avoid lateral levers.
- Take adequate precautions to avoid occlusal overload in correspondence to any prosthetic cantilevers.
- Bear in mind the resilience of neighboring teeth when planning for single tooth restorations. Establish full contact on the implant crown only during maximal clenching ensuring an even load distribution on all teeth during maximum chewing force.
- Check for parafunctional habits. Consider changes during recall appointments.
- In case of any changes to the occlusal scheme in other areas, evaluate the consequences for the implant restoration and, if required, take appropriate measures.
- Advice for the dental laboratory: The abutment design must not be manipulated at the areas of the connection taper or adjacent to the sulcus.

Please read this manual carefully before using the system for the first time and always observe the clinical indications, directions and notes in the instructions for use of the system components and instruments.

Furthermore, we recommend that all users attend a training course specific to the system prior to first using a new implant system.

Some products may not be available in all countries.

Please contact your Dentsply Sirona Implants representative to obtain up to date information on the product range and on availability.

To improve readability for our customers, Dentsply Sirona Implants does not use ® or ™ in body copy. However, Dentsply Sirona Implants does not waive any right to the trademark and nothing herein shall be interpreted to the contrary.

## CONTENTS

### Treatment planning

Aspects of treatment planning	4
Conventional treatment planning	6
Computer-guided treatment planning	7

### Implant healing

Submerged - transgingival - immediate restoration	8
---	---

### Prosthetic concept

The prosthetic principle of Ankylos	10
Ankylos prosthetics navigator	13
Solutions for single-tooth restoration	14
Solutions for larger tooth gaps	16
Solutions for the edentulous jaw	18
Basic guidelines for soft tissue management	20

### Impression taking

Transfer on implant level without index (C/)	24
Transfer on implant level with index (/X)	28

### Ankylos® esthetic restorations

Crowns and bridges on Ankylos Balance Anterior C/ or /X	
crowns on Ankylos Cercon Balance C/	32
Ankylos TitaniumBase C/ or /X	40
Atlantis abutments	44

### Ankylos® Regular C/ or /X

Crowns and bridges on Ankylos Regular C/ or /X	48
--	----

### Ankylos® Balance Base Abutment C/

Bar-supported overdentures and bridges, also CAD/CAM-fabricated, on Ankylos Balance Base Abutment C/	58
The SmartFix concept	60

### Ankylos® SynCone® C/

Overdentures on Ankylos SynCone C/	74
------------------------------------	----

### Ankylos® Attachments

Overdentures on Ankylos Snap Attachment C/	88
Overdentures on Ankylos Locator C/	92

### Ankylos® Standard C/

Crowns, bridges and bar-supported dentures on Ankylos Standard C/	96
---	----

# Treatment planning

## Aspects of treatment planning

Precise planning for any implantological procedure in close coordination between practitioners and laboratory is the basic prerequisite for lasting therapeutic success. All suitable measures and alternatives that will fulfill the expectations of the patient in terms of function and esthetics of the implant prosthetic rehabilitation should be stipulated in the planning.

Today, along with conventional treatment planning, treatment can be planned using computer-guided facilities for three-dimensional "crown down" treatment with planning of the optimal implant placement from the point of view of the desired prosthetic restoration, both functionally and esthetically.





The basis of treatment planning is always a thorough discussion with the patient with a view towards determining the wishes and perceptions of the patient, excluding contraindications and clarifying matters thoroughly with the patient. Next, a complete general and specific medical history is taken and an intraoral diagnostic assessment is made with an analysis of the initial anatomical situation.

The following points should be taken into account:

- Medical history
- General diagnosis - elimination of contraindications
- Specialist consultation where there are risk factors
- Extensive intraoral diagnosis (PAR diagnosis, functional examination, reasons for tooth loss, assessment of the existing tooth replacement, radiological examination)

After all the diagnostic details have been submitted and evaluated, the treatment can be planned.

This comprises the following elements:

- Preprosthetic planning
- Surgical planning
- Schedule
- Cost projection

# Conventional treatment planning

## Preprosthetic planning

Preprosthetic planning with the dental technician is the most important factor for the esthetic and functional success of the implant procedure.

## Surgical planning

During preoperative planning it is very important to check that the height and width of the jawbone is sufficient for placement of the implant.

The target is the best possible, tooth-analog placement of the implants. During the first planning session with the patient situation impressions are made to be used as the base for laboratory-fabricated diagnostic aids.

A diagnostic wax-up of the planned prosthetic restoration is made.

A thermoformed splint with radiographic balls that can be accurately repositioned in the patient's mouth is prepared. It can be subsequently modified to a conventionally fabricated surgical template.

The width of the vestibular and oral lamellae should be at least 1.5 mm after implant placement. The position and direction of important anatomical structures such as the mental foramen or maxillary sinus must be determined by radiology.

Grafted regions must be confirmed to have completely regenerated to a mechanically stable state before preparation.

Planned prosthetic measures must be checked to ensure that they can actually be implemented with appropriate surgical procedures. All aspects of preprosthetic and surgical planning interact directly with one another. Every change in the preprosthetic planning will affect the surgical planning and vice versa. This will also include the number, diameter, lengths, positions and alignment of the implants.

The available bone volume and important anatomical structures are examined in an x-ray image, which is prepared with the laboratory-fabricated x-ray template with the radiographic balls in the patient's mouth. The dimensions of the intraoral structures can be calculated from the defined diameter of the radiographic balls, taking the magnification factors resulting from radiological processes into account.

The implant lengths are selected by placing the transparent radiographic template on the OPG. If desired, the x-ray analysis must consider a subcrestal implant position (note magnification scale).

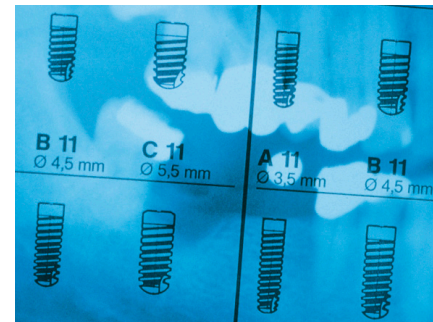
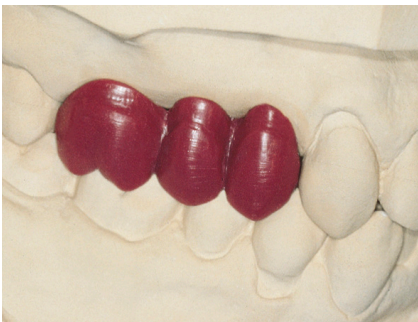

# Computer-guided treatment planning

Digital treatment planning based on three-dimensional imaging procedures enables the therapy to be planned with absolute accuracy and makes the result of the treatment exactly predictable.

Dentsply Sirona Implants offers a complete solution for digital treatment planning and full-guided implant placement based on the world-renowned Simplant software.

The advantages over conventional planning include:

- Safe three-dimensional planning in the sub-millimeter range and with reference to the desired restoration
- Automatic collision control, which displays too narrow clearances between implants or to the nerve
- Information on peri-implant bone quality for accurate conclusions on the expected primary stability

An individual Simplant drill guide is fabricated using stereolithography, based on the digital planning data. Depending on the individual case scenario, the guide is prepared tooth-supported, mucosa-supported or bone-supported, thus enabling a complete and accurate transfer to the patient's mouth.

The Sleeve-on-Drill drill system, drills with a guide sleeve that can be attached to the instrument for precise guidance in the template, has been especially developed for template-guided implant placement in order to facilitate accurate, straight-forward implant placement with the added security of the drill stop.

These instruments enable simpler and precisely fitting placement of the implants with the reliability of the drill stop.

Simplant drill guides are also available with lateral access for easier management of the instruments, even with a restricted oral cavity.

Digital treatment planning with Simplant.

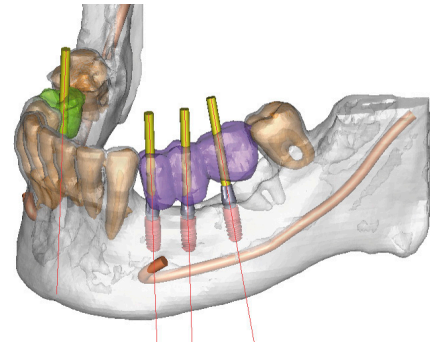

Patient-specific Simplant guide.



Sleeve-on-drill drill system and drill guide with lateral access.





# Implant healing

## Submerged – transgingival – immediate restoration

Depending on the indication and the type of restoration planned, the Ankylos system enables various healing modes after insertion of the implants:

- Submerged after placing the cover screw
- Transgingival with gingiva former
- Immediate restoration / immediate loading

Thanks to its TissueCare connection, Ankylos uniquely combines the advantages of one-piece and two-piece implant systems: a one-piece transgingival restoration without bone loss, with the flexibility of two-piece systems in respect of an unaltered, esthetically perfect restoration in the long term.





## Submerged healing

In cases of a two-stage treatment protocol with submerged healing, the implant is sealed with the cover screw and the mucosa is sutured over the implant. An unloaded healing phase should be ensured.

As a rule, the implant healing period is between three and four months, regardless of location in the maxilla or the mandible. Grafting procedures performed simultaneously in the region of implant placement are an exception. Here, the healing period should be increased accordingly.

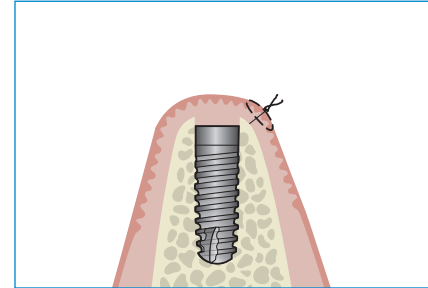

## Transgingival healing

Transgingival implant healing enables a second surgical procedure to be dispensed with. At the same time, you are optimally utilizing the regeneration potential of the soft tissue to form a perfect emergence profile. The implant is sealed using a gingiva former. The geometry of the subsequent prosthetics can be taken into consideration as early as the selection of the diameter. Since the gingiva former is a separate component to the implant, in contrast with one-piece transgingival implants, an abutment of another emergence height can be selected where the gingival height is altered during the healing period and hence the esthetics can be guaranteed.

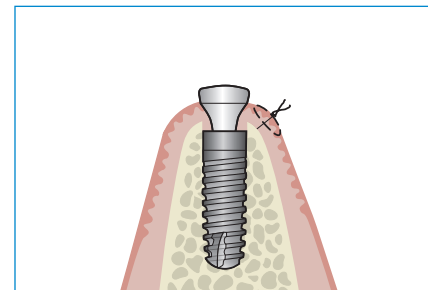

## Immediate restoration and/or immediate loading

Provided that the clinical prerequisites for an immediate restoration with a provisional have been met, this presents an excellent opportunity to provide the patient with an implant-supported restoration directly after insertion of the implant.

The second surgical procedure is no longer necessary; your patient sees an immediate result and, as with classic transgingival healing with a gingiva former, you are utilizing the soft tissue regeneration potential optimally to form a perfect emergence profile.

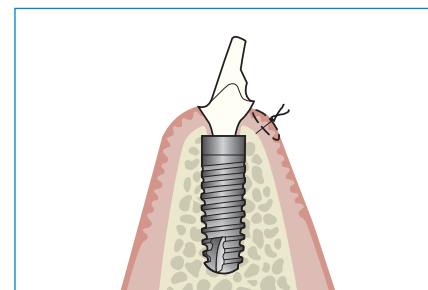

# Prosthetic concept

## The prosthetic principle of Ankylos<sup>®</sup>

Ankylos implants are available in four diameters and in six lengths. This allows the surgeon to select the best possible implant according to the indication and the anatomical conditions.

Thanks to the geometry of the Ankylos TissueCare connection, identical for all implant diameters, you can provide each implant with all available prosthetic components and thus you can obtain the optimal prosthetic result, regardless of surgical requirements.

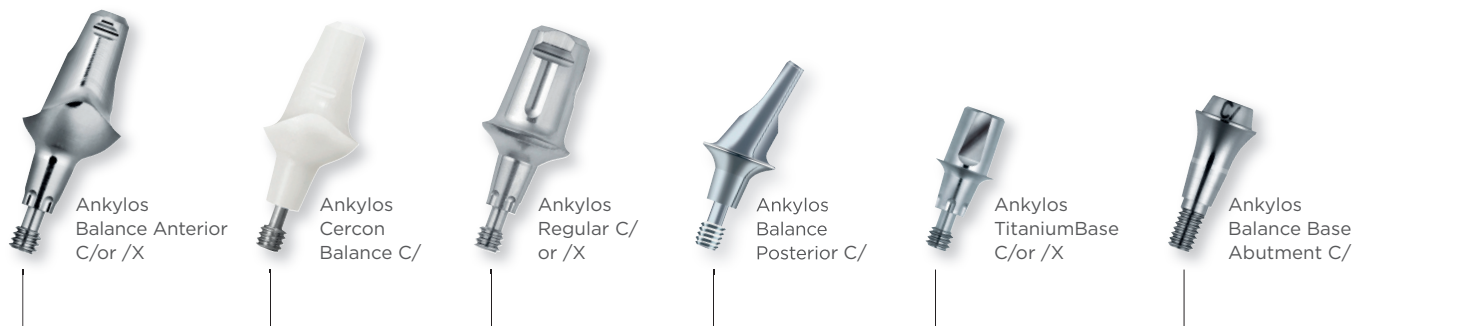



The Ankylos system includes a variety of prosthetics ranges from which you can choose depending on the indication and your preferred approach. Each range of prosthetics contains abutments in various sizes and forms, with and without positioning aid (index), if needed. Hence, a large variety of prosthetic conditions are provided, with the optimal functional and esthetic solution.

### Freely combinable

Thanks to the identical dimensions of the tapered connection, identical for all implant diameters, every Ankylos prosthetic abutment fits into every implant of any diameter. Hence, a decision as to the prosthetic strategy can still be made, even after implant healing or when the abutment is uncovered.

In fact, the compatibility of Ankylos prosthetic abutments offers further crucial advantages:

- The number of prosthetic parts required is markedly reduced, as compared with diameter-specific abutment concepts
- The diameter and length of the implant is solely selected commensurate with the bone volume
- The abutment is only selected in keeping with prosthetic requirements

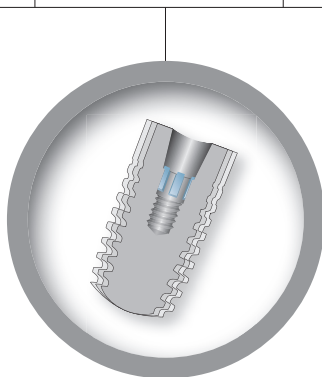
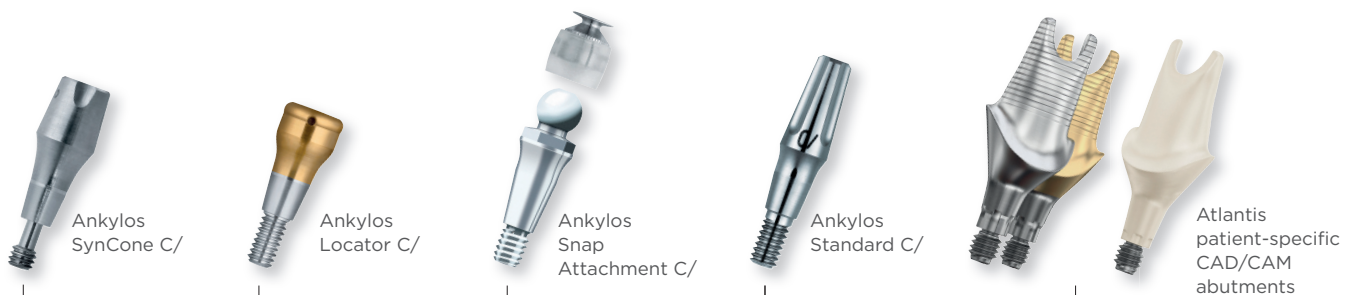

# The prosthetic principle of Ankylos<sup>®</sup>

Based on the friction-locked and keyed TissueCare connection, the Ankylos system concept also facilitates high flexibility in placing the abutments in the implant. The abutments with tapered connection geometry (C/) can be freely turned in the implant and, hence, can always be positioned at the optimal angle for the respective prosthetic restoration.

Additional indexed prosthetic components (/X) may facilitate positioning the abutments, provided that the abutment is not required to be freely rotatable.

All components marked C/X, C/ or /X will fit Ankylos C/X. Restorations using Ankylos plus implants are only possible using components with the C/ marking.

## Indexing option

Regardless of which implant is placed, abutments from the Ankylos Balance Anterior and Regular prosthetics ranges as well as the TitaniumBase, offer you the choice between indexed and non-indexed prosthetic restorations:

- Indexed components for precise, straightforward placement of the abutments in a range of six positions
- Non-indexed components for freely positionable abutments

The tapered Ankylos TissueCare connection provides both options with optimal stability and rotation locking.

The placement of the prosthetic abutments can also be simplified by using the positioning aid (index) whenever this facilitates the prosthetic procedure. If the index hampers the procedure, abutments fitted with the tapered connection alone can be used.

All Ankylos prosthetic abutments are laser-marked corresponding with your intended use:

- Components with the "C/" marking use only the taper for the connection and are not indexed.
- Components with the "/X" marking are indexed. These use the index for positioning the abutments in six possible positions.
- Components with the "C/X" marking are used for indexed or non-indexed prosthetics.

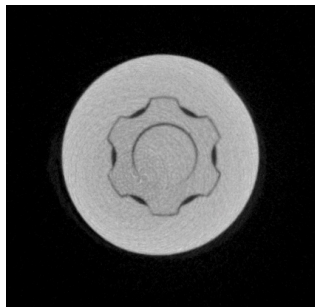
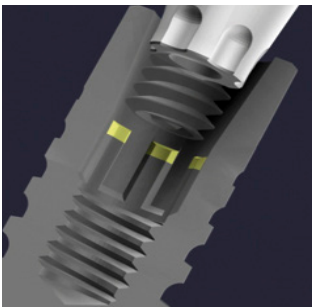

c/



/X



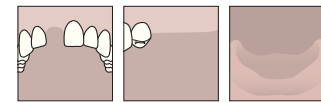



# Ankylos® prosthetics navigator

Depending on the indication and the type of prosthetic restoration intended, the Ankylos system offers different options for fabricating the suprastructure. Since all abutments are freely combinable a decision for the prosthetic strategy can still be made even after implant healing or when the abutment is uncovered.

Hence, prosthetically, the best functional and esthetic solution is realized for each individual case.

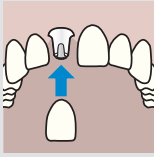
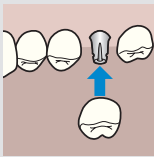
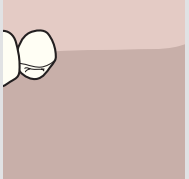
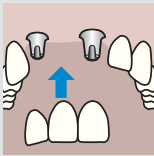
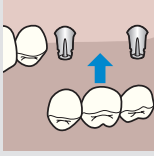
Detailed directions for selecting the most suitable prosthetic procedure for the individual case can be found on the following pages.

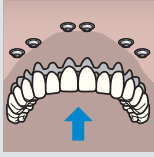
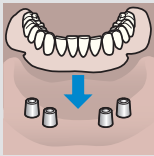
 <p>Single-tooth replacement</p>	 <p><b>Crown / anterior region:</b></p> <ul style="list-style-type: none"> <li>• Ankylos Balance Anterior C/ or /X</li> <li>• Ankylos Cercon Balance C/</li> <li>• Ankylos TitaniumBase C/ or /X</li> <li>• Atlantis patient-specific abutments</li> </ul>
	 <p><b>Crown / posterior region:</b></p> <ul style="list-style-type: none"> <li>• Ankylos Regular C/ or /X</li> <li>• Ankylos Balance Posterior C/</li> <li>• Ankylos Standard C/</li> <li>• Ankylos TitaniumBase C/ or /X</li> <li>• Atlantis patient-specific abutments</li> </ul>
 <p>Larger tooth gaps</p>	 <p><b>Bridge / anterior region:</b></p> <ul style="list-style-type: none"> <li>• Ankylos Balance Anterior C/ or /X</li> <li>• Ankylos TitaniumBase C/ or /X</li> </ul>
	 <p><b>Bridge / posterior region:</b></p> <ul style="list-style-type: none"> <li>• Ankylos Regular C/ or /X</li> <li>• Ankylos Balance Posterior C/</li> <li>• Ankylos Standard C/</li> <li>• Ankylos Balance Base Abutment C/</li> <li>• Ankylos TitaniumBase C/ or /X</li> <li>• Ankylos Balance Base Abutment C/, Atlantis bridge</li> </ul>
 <p>Edentulous jaw</p>	 <p><b>Bridge (fixed):</b></p> <ul style="list-style-type: none"> <li>• Ankylos Balance Base Abutment C/, Atlantis bridge</li> <li>• Ankylos Regular C/ or /X</li> <li>• Ankylos Balance Posterior C/ or Ankylos Standard C/</li> <li>• Atlantis Bridge</li> </ul>
	 <p><b>Overdenture (removable):</b></p> <ul style="list-style-type: none"> <li>• Ankylos Balance Base Abutment C/, Atlantis bar</li> <li>• Ankylos Balance Base Abutment C/</li> <li>• Ankylos SynCone C/</li> <li>• Ankylos Locator C/</li> <li>• Ankylos Snap Attachment C/</li> </ul>

# Solutions for single-tooth replacement

For the replacement of single teeth with implant-supported single crowns, the Ankylos system has a wide selection of prosthetic options for fabricating naturally and esthetically pleasing restorations with durable retention of the peri-implant hard and soft tissue.

Select the most suitable solution for the individual case based on the following overview. Both, pre-fabricated abutments for conventionally fabricated prosthetics as well as patient-specifically planned and CAD/CAM-fabricated abutments for highly esthetic restorations are at your disposal.

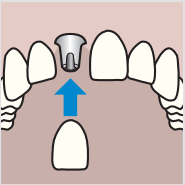
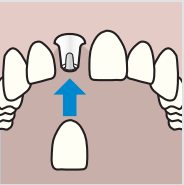
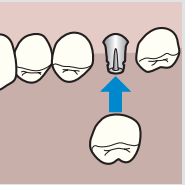
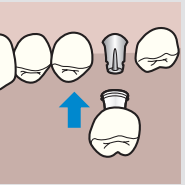
Conventionally fabricated solutions for <b>Crowns / anterior region</b>		Conventionally fabricated solutions for <b>Crowns / posterior region</b>	
			
<p><b>Esthetic:</b>  <b>Ankylos Balance</b>  <b>Anterior C/ or /X</b></p> <p>The design of the Ankylos Balance Anterior C/ and /X abutments is specially adapted to the anatomical and peri-implant situation in the anterior region. A wide assortment of indexed and non-indexed design variants and the patient-specific individualisation of the abutments provide optimal integration for the crowns which can be cemented or laterally screw-retained.</p> <p><b>Directions: see page 32 ff.</b></p>	<p><b>Highly esthetic:</b>  <b>Ankylos Cercon</b>  <b>Balance C/</b></p> <p>Thanks to its brilliant light dynamics, porcelain restorations on Ankylos Cercon Balance C/ zirconium oxide abutments provide superior esthetics for the anterior region and, impressively, are extremely stable at the same time. The basic design, identical to the Anterior Balance, is likewise customizable and is available in various design variants. The two shades of white of this outstandingly biocompatible material create the perfect integration for the cementable crowns.</p> <p><b>Directions: see page 32 ff.</b></p>	<p><b>Esthetic:</b>  <b>Ankylos Regular C/ or /X</b></p> <p>The particular strength of the Ankylos Regular C/ and /X abutments is in the posterior region. Thanks to the convex sulcus design, you can also optimally fulfill the esthetic requirements of your patients in the side tooth region. Customizable indexed and non-indexed abutments with a wide range of forms and sizes facilitate the efficient fabrication of the crowns which can be cemented or laterally screw-retained.</p> <p><b>Directions: see page 48 ff.</b></p>	<p><b>Functional:</b>  <b>Ankylos Regular C/ or /X</b>  <b>with 3-in-1 cap</b></p> <p>If you require a simple, economical solution, Ankylos Regular C/ and /X abutments with 3-in-1 cap are your first choice. The abutment selected at the chairside remains in the mouth during the entire treatment procedure; there is no need to change abutment components. Taking the impression on the abutment level, fabricating a temporary denture at the chairside and fabricating the cementable crown in the laboratory are all performed on the multi-functional cap, which is simply clicked onto the abutment in the patient's mouth.</p> <p><b>Directions: see page 48 ff.</b></p>

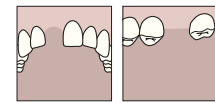

CAD/CAM prosthetics for  
**Crowns / anterior and posterior region**

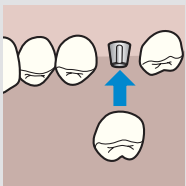

**Functional:  
Ankylos Standard C/**

Ankylos Standard C/ abutments are another option for straight-forward reconstruction of edentulous gaps by means of caps that can be attached to the integrated abutments. Due to the narrower design of the standard abutments, these are particularly suitable for more confined spaces. Both cementable and screw-retained crowns can be fabricated on Ankylos Standard C/ abutments.

**Directions: see page 96 ff.**

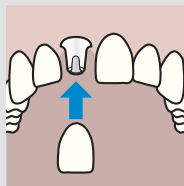

**Patient-specific and highly esthetic: Ankylos TitaniumBase C/ or /X**

The Ankylos Titanium-Base allows for the fabrication of esthetically high-quality ceramic abutments with titanium core. With these adhesive bases with prefabricated taper connection, available both, indexed and non-indexed, patient-specific restorations can be fabricated that are as close as possible to the natural esthetics of the anterior and posterior regions.

**Directions: see page 40 ff.**

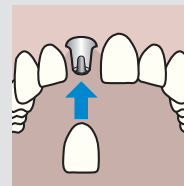

**Patient-specific and highly esthetic: Atlantis CAD/CAM abutments**

Atlantis abutments for Ankylos are the one-piece solution for fabrication of patient-specific CAD/CAM restorations. The abutments are centrally fabricated on the basis of the individual anatomical conditions. They are available indexed made from titanium, gold-shaded titanium and zirconia; available in different shades. Your dental laboratory will coordinate the process and elaborate the crown just as usual.

**Directions: see page 44 ff. corresponding to Ankylos Balance C/ or /X**

# Solutions for larger tooth gaps

Ankylos also provides a large range of options for restoration in larger edentulous gaps and free-ends – both, for conventional restorations as well as for digitally fabricated CAD/CAM prosthetics. The following is an overview of the options for providing your patients with a multi-span bridge.

As well as a bridge, in these cases, restoration is also possible using single crowns following a tooth-by-tooth concept. For this purpose, make your decision using the options shown on the previous page for single-tooth restorations.

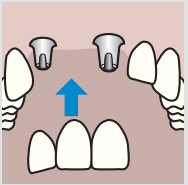
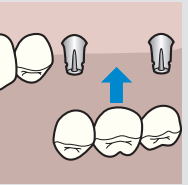
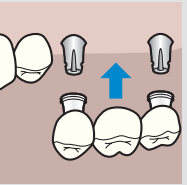
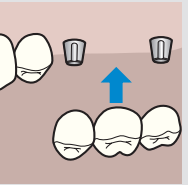
Conventionally fabricated solutions for <b>Bridges / anterior region</b>	Conventionally fabricated solutions for <b>Bridges / posterior region</b>		
			
<p><b>Esthetic:</b> Ankylos Balance Anterior C/ or /X</p>	<p><b>Esthetic:</b> Ankylos Regular C/ or /X Ankylos Balance Posterior C/</p>	<p><b>Functional:</b> Ankylos Regular C/ or /X with 3-in-1 cap</p>	<p><b>Functional:</b> Ankylos Standard C/</p>
<p>The design of the Ankylos Balance Anterior C/ and /X abutments is specially adapted to the anatomical and peri-implant situation in the anterior region. A wide assortment of indexed and non-indexed design variants and the option of grinding the abutments provide optimal integration for the bridges which can be cemented or laterally screw-retained.</p>	<p>The particular strength of the Ankylos Regular C/ and /X abutments is in the posterior region. Thanks to the convex sulcus design, you can also optimally fulfill the esthetic requirements of your patients in the side tooth region. Indexed and non-indexed customizable abutments with a wide range of forms and sizes facilitate the efficient fabrication of the bridges which can be cemented or laterally screw-retained.</p>	<p>If you require a simple, economical solution, Ankylos Regular C/ and /X abutments with 3-in-1 cap are your first choice. The abutment selected at the chairside remains in the mouth during the entire treatment procedure; there is no need to change abutment components. Taking the impression on the abutment level, fabricating a temporary denture at the chairside and fabricating the cementable bridge in the laboratory are all performed on the multi-functional cap, which is simply clicked onto the abutment in the patient's mouth.</p>	<p>Ankylos Standard C/ abutments are another option for straight-forward reconstruction of edentulous gaps by means of caps that can be attached to the integrated abutments. Due to the narrower design of the standard abutments, these are particularly suitable for more confined spaces. Both cementable and screw-retained bridges can be fabricated on Ankylos Standard C/ abutments.</p>
<p><b>Directions: see page 32 ff.</b></p>	<p><b>Directions: see page 48 ff.</b></p>	<p><b>Directions: see page 48 ff.</b></p>	<p><b>Directions: see page 96 ff.</b></p>



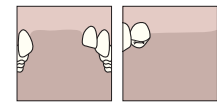

CAD/CAM prosthetics for  
**Bridges / anterior and posterior region**

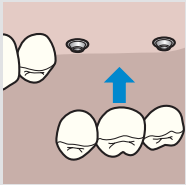

**Simple:  
Ankylos Balance  
Base Abutment C/**

If straightforward and efficient fabrication of the bridge should be a priority, a bridge restoration on Ankylos Balance Base Abutments C/ is an option. The prosthetic abutments can be selected both in the laboratory and directly at the chair-side. As cementing is contraindicated due to the low abutment height, only screw-retained bridges can be fabricated on these abutments.

**Directions: see page 58 ff.**

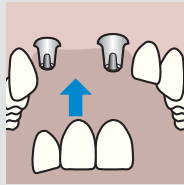

**Patient-specific and highly esthetic: Ankylos TitaniumBase C/ or /X**

The Ankylos Titanium-Base allows for the fabrication of esthetically high-quality ceramic abutments with titanium core. With these adhesive bases with prefabricated taper connection, available both, indexed and non-indexed, patient-specific restorations can be fabricated that are as close as possible to the natural esthetics of the anterior and posterior regions.

**Directions: see page 40 ff.**

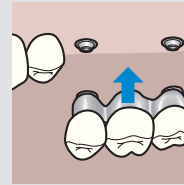

**Individual by CAD design:  
Ankylos Balance Base  
Abutment C/ with  
Atlantis bridge**

With patient-specific, screw-retained Atlantis bridgework on Ankylos Balance Base Abutments C/, you can provide edentulous and partially edentulous patients with a fixed restoration of utmost precision. The bridge framework is centrally designed and fabricated with the collaboration of your dental laboratory and fits tension-free. The individually milled metal structure is veneered in your dental laboratory as usual.

**Directions: see page 58 ff.**

# Solutions for the edentulous jaw

With Ankylos, the edentulous jaw can be restored either using an implant-supported bridge (fixed) or a removable overdenture anchored to the implant.

Here, too, there are several options for both methods – from straightforward, standardized solutions right up to customized premium restorations designed using the CAD/CAM process.

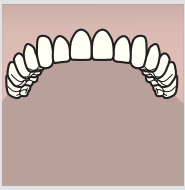

Conventionally and CAD/CAM-fabricated solutions for **Bridges (fixed)**

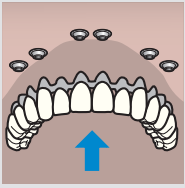

**Individual by CAD design: Ankylos Balance Base Abutment C/ with Atlantis bridge**

With patient-specific screw-retained Atlantis bridgework on Ankylos Balance Base Abutments C/, you can also provide edentulous and partially edentulous patients with CAD/CAM bridges on six or more implants, tension-free and with utmost precision. Dividing the spans is not necessary. In addition, the individually milled metal structure that is veneered in your dental laboratory as usual will ensure a brilliant esthetic result.

**Directions: see page 58 ff.**

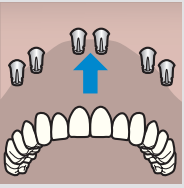

**Esthetic: Ankylos Regular C/ or /X**

Ankylos Regular C/ and /X abutments with convex sulcus design guarantee the optimal combination of functionality and esthetics, even for extensive multi-span bridge constructions. Customizable indexed and non-indexed abutments with a wide range of forms and sizes facilitate the efficient fabrication of the bridges, which can be cemented or laterally screw-retained.

**Directions: see page 48 ff.**

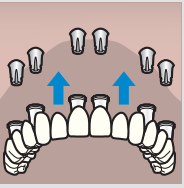

**Functional: Ankylos Regular C/ or /X with 3-in-1 cap or Ankylos Standard C/**

Without doubt, the preeminent choice in the prosthetics range when an economical, straightforward procedure that is gentle on the patient is required, the simplified procedure using caps that can be attached to the abutment is also suitable for extensive prosthetic work. Both Ankylos Regular C/X and Ankylos Standard C/ abutments with the correct caps for each situation can be used here.

**Directions: see page 48 ff. (Regular) and page 96 ff. (Standard)**

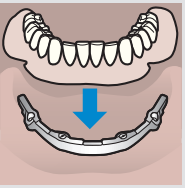

**Individual by CAD design: Ankylos Balance Base Abutment C/ with Atlantis bar**

With patient-specific Atlantis bar restorations on Ankylos Balance Base Abutments C/, edentulous patients can be provided with removable CAD/CAM restorations on implants, tension-free and with utmost precision. The bar is centrally fabricated with the collaboration of your dental laboratory in a customized design and is seated tension-free, even on the first insertion. The prosthesis is fabricated in the laboratory as usual.

**Directions: see page 58 ff.**



Conventionally and CAD/CAM-fabricated solutions for  
**Overdentures (removable)**

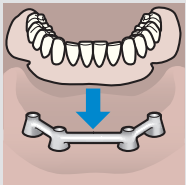

**Functional:  
Ankylos Balance Base  
Abutment C/ bar**

A simple option for the fabrication of functional bar-supported prostheses for the maxilla and the mandible on Ankylos Balance Base Abutments C/. The prosthetic abutments can be selected in the laboratory as well as directly at the chairside. Prefabricated high gold-content precious metal alloy or titanium components facilitate the efficient fabrication of the bar prosthesis in the laboratory.

**Directions: see page 58 ff.**

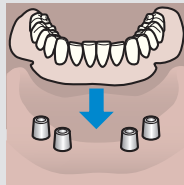

**Prefabricated  
with immediate  
restoration option:  
Ankylos SynCone C/**

Ankylos SynCone C/ abutments facilitate rapid and minimal invasive restoration of the edentulous mandible with an immediately loaded prosthesis on four prefabricated interforaminally telescopic crowns. Ankylos SynCone can also be used in the maxilla and the mandible for the purposes of delayed restoration. Intraoral bonding provides the prosthesis with a tension-free fit. The delicate denture saddle gives a high degree of wearing comfort and allows excellent hygiene.

**Directions: see page 74 ff.**

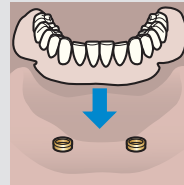

**Simply flexible:  
Ankylos Locator C/**

With the Ankylos Locator, you secure coverdentures in the edentulous jaw fast and simple, even when space is limited. The self-aligning design supports fixation in the mouth with one click yet for patients with restricted mobility. Prosthesis retention can be defined individually and axial divergences up to 40° between two implants can be compensated.

**Directions: see page 92 ff.**

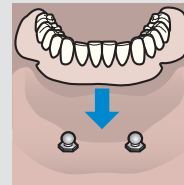

**Simple:  
Ankylos Snap  
Attachment C/**

Ankylos Snap Attachment C/ abutments allow a straightforward, inexpensive fixation for overdentures on two implants in the edentulous mandible. The restoration can be fabricated directly at the chairside or the prosthesis can be fabricated in the laboratory.

**Directions: see page 88 ff.**

# Soft tissue management

## Step-by-step: Uncovery and soft tissue management

Where there is submerged implant healing, as a rule, the minimally invasive uncovery of the implants is performed after three to four months and, following this, the contouring of the soft tissue, as described below.

The following steps are not required with transgingival implant healing or in cases of an immediate restoration using a short-term provisional. An individual provisional can be manufactured as required. Otherwise, the impression is taken.

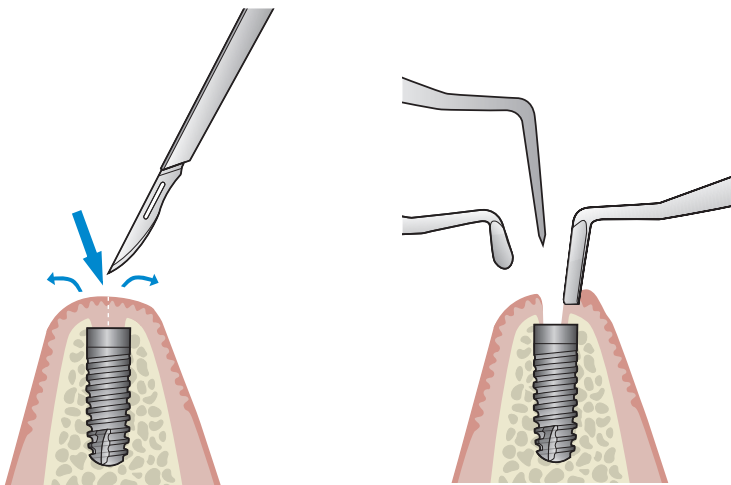

### Incision

After locating the implant and selective anesthesia directly above the implant (e.g. intraligamentous system), a small crestal incision will reveal the implant surface.

Locating the implants may be facilitated by again using the drill guide.

### Implant uncovery

The wound edges are then spread slightly, without exposing the entire surface of the implant, using an angled raspator. Locate the central thread of the cover screw using the probe.

Remove connective tissue or bone above the cover screw with the sharp curette, if this is necessary for the rest of the procedure.

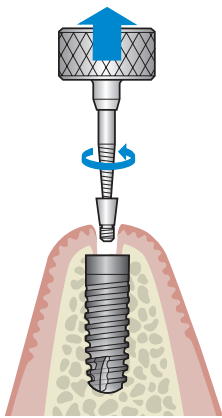
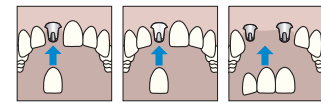

### Removing the Ankylos C/X cover screw

Insert the unscrew instrument for cover screws into the large 12 mm diameter screwdriver handle and, by gently turning in a counterclockwise direction, screw this into the internal thread of the cover screw. This allows the unscrew instrument to grip the internal thread of the cover screw and to unscrew it. This prepares the implant for fitting the gingiva-forming components.

To remove the cover screw from the unscrew instrument, clamp the cover screw in the rear of a pair of tweezers or hold with a pair of forceps. The unscrew instrument is then turned in a clockwise direction until it disengages from the cover screw.

# Basic guidelines for soft tissue management with Ankylos®

Free from micro-movement and conceived for bacteria tightness, the Ankylos TissueCare connection ensures stable tissues on the long term.

The advantages of this specific connection geometry however only become effective, if the procedure of soft tissue contouring complies with the following guidelines.

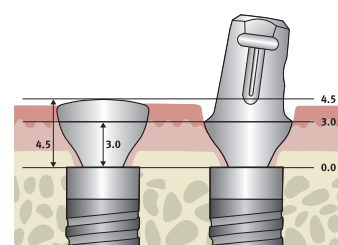
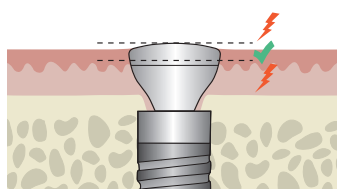
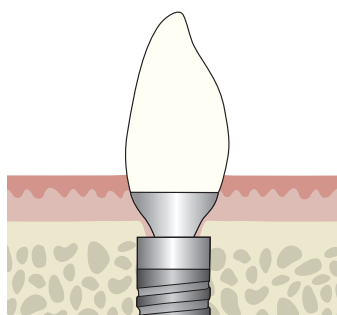

## Transition implant-abutment displaced toward the center

Some special characteristics have to be considered for soft tissue contouring and the choice of the final abutment:

- Due to the taper connection, the diameter of the Ankylos abutments on the implant level is markedly smaller than the diameter of the implant itself.
- Soft tissues are also located under the flanks of the abutment.

## Selection of the correct gingiva height

- The illustration shows the correct usage of a gingiva former.
- If the gingival level lies in the area between the two dotted lines, the correct gingiva former has been selected.
- If the level is above the upper dotted line, a higher gingiva former should be selected; if it is below the lower dotted line, a lower one should be selected.

## Selection of the gingiva former corresponding to the abutment

- The gingiva former and final abutment should be selected so that they correspond in prosthetic range and gingival height.
- The description of the height of the gingiva former as shown above (GH 3.0) only refers to the region from the interface level to the edge of the crown.
- The entire gingiva former is always approximately 1.5 mm higher than the nominal height, viewed from the interface level (here: overall height 4.5 mm), in order also to shape the first part of the crown profile.

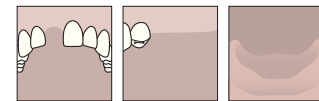

Gingiva former and final abutment should be selected in correspondence of prosthetic range and gingiva height. Therefore, please make sure to use the components indicated for the respective prosthetic range in the following chapters.

Gingiva formers must be sterilized before use.

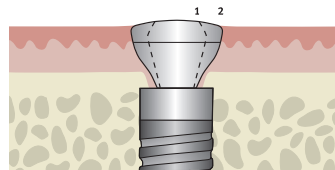
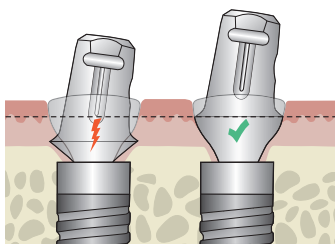

If the soft tissue passage formed is smaller than the profile of the abutment used, this may result in an avoidable compression of the gingiva.

This effect occurs when:

1. The gingiva former is markedly higher than the gingival level and the abutment used later on.
2. The gingiva former is suitable to the gingival height, but the gingival height of the final abutment is lower than that of the gingiva former used (see illustration).
3. The final abutment has a larger diameter than the gingiva former used (e.g. in case of a different prosthetic range).

### Gradual widening of the gingiva

- In case of stiff mucosa, the tissues must be gradually widened to the desired diameter.
- Here, commence first with a small sulcus former. Switch to a larger diameter after 5-7 days.
- The shape of the soft tissue passage should at least correspond to the abutment geometry, in case of doubt, it should rather be selected larger.
- Due to the counter force exerted by the gingiva, an undersized contouring might lead to problems when placing the abutments. Over-compression of the gingiva may result in recession of the soft tissue.

### Naturally beautiful teeth, even after many years

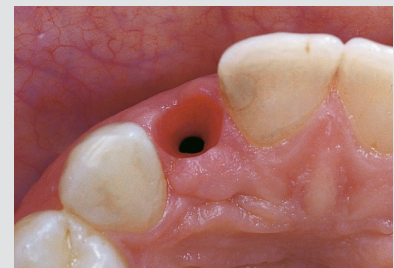

Irritation-free, healthy soft tissues prior to incorporating the final restoration.



Natural soft tissue contour thanks to the TissueCare connection (courtesy of Dr. Eduard Eisenmann, Berlin/D).

Advantages of the Ankylos system supporting esthetics:

1. Provides adequate space for healthy, protective soft tissues
2. Protects areas of thin soft tissue
3. Prevents the abutment from possible shimmering through the tissues
4. Ensures optimal esthetic results



# Impression taking C/

Based on the friction-locked and keyed TissueCare connection, the Ankylos system concept offers both abutments with tapered connection geometry (C/ ) only and abutments which - in addition to the taper connection geometry- feature an additional prosthetic indexed ( /X).

Therefore also the components for transfer the implant position from the patient to the working model offer the choice of a non-indexed or a indexed protocol.

Once using the non-indexed transfer abutment also use non-indexed implant analogs to avoid misunderstandings.



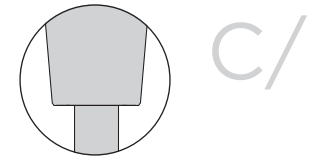

# Step-by-step: Impression taking C/ (without index) on implant level



Ankylos Balance C/  
transfer post with screw



Ankylos Balance C/  
repositioning post

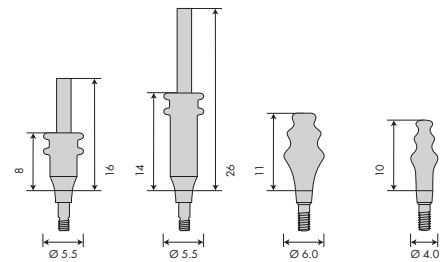

Diameters and heights

## Impressions for Ankylos abutments C/ with open tray

- For transferring the implant position to the master cast using the PickUp technique (open tray)
- Available in two lengths
- Two-piece with separate screw Ankylos Balance C/

## Impressions for Ankylos abutments C/ with closed tray

- For transferring the implant position to the master cast using the repositioning technique (closed tray)
- Repositioning post narrow for cases with limited space available
- One-piece with integrated thread

## Step-by-step: Impression taking C/ (without index)

The impression for prosthetic restorations on Ankylos C/ abutments is taken with non-indexed Ankylos Balance C/ transfer posts favorably using the PickUp technique (open tray). Components for a transfer impression with repositioning technique (closed tray) are also available.

The following step-by-step guide describes both alternatives for restorations on non-indexed abutments. When using indexed Ankylos /X abutments, impressions have to be taken with indexed transfer components to transfer the position of the index (see page 29).

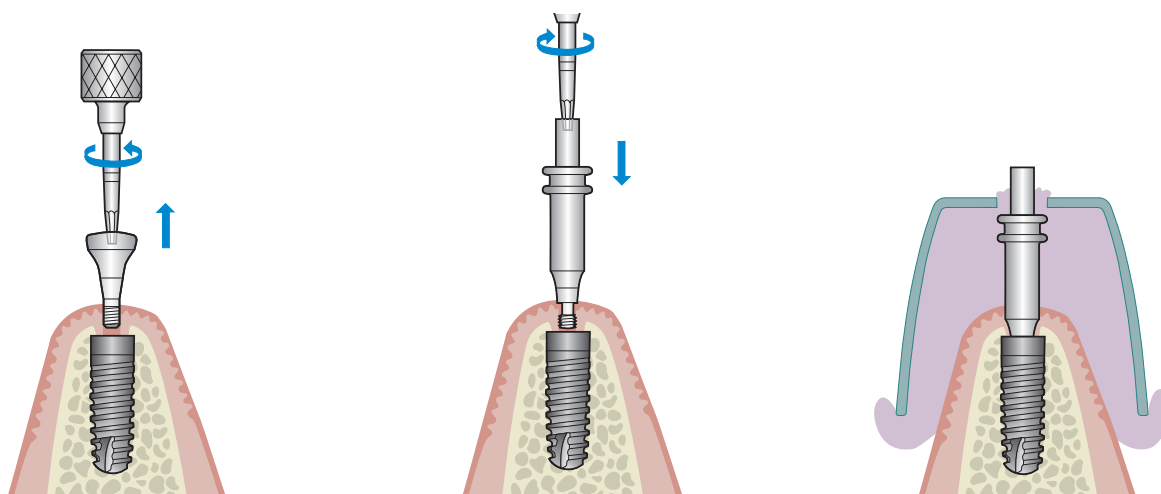

### Removing the sulcus former

Remove the Ankylos sulcus or gingiva former for the impression. The connection taper of the implant must be cleaned of any tissue residue.

### Impression, non indexed, PickUp technique (open tray)

Depending on the position of the implant, insert the short or the long Ankylos Balance C/ transfer post into the connection taper of the implant and attach by using the transfer screw of the desired length. By doing so, hand-tighten the transfer screw. The internal hex in the screw head is an aid for releasing the screw only. Block this with wax prior to taking the impression.

The transfer post must be correctly fitted in the implant connection taper. The transfer screw can be shortened, if necessary, and provided with a slot.

The impression is taken using an open tray. After the impression material has set, unscrew the transfer screw and remove the impression. The transfer post remains in the impression. The impression with transfer post and transfer screw is sent to the laboratory for casting the model. The production of a mucosa mask is essential here. In coordination with the practitioner, the prosthetic abutment is selected in the laboratory and adapted, where necessary, to the individual situation. The taper area must not be touched in this process.

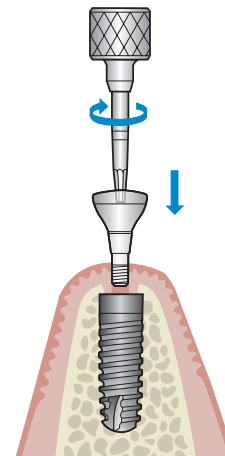
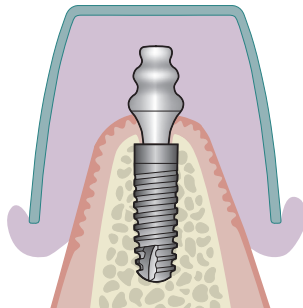
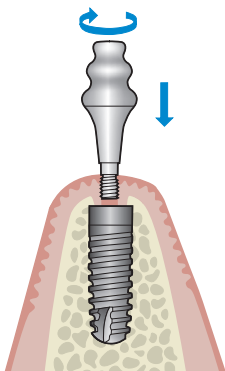
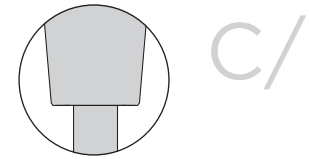

### Alternative: Repositioning technique (closed tray)

Insert the Ankylos Balance C/ repositioning post into the implant connection taper. Fasten the post hand-tight. The internal hex in the screw head is an aid for releasing the screw. Please block this with wax prior to taking the impression. The impression is taken using silicone or hydrocolloid with a closed tray. After the impression material has set, remove the impression. Unscrew the repositioning post from the implant, connect the non-indexed implant analog and place the repositioning post back to the impression.

Ensure that the blockage has been removed from the hex in this process and that no impression material overlaps remain. The impression with the repositioning post is sent to the laboratory for casting the model. The production of a mucosa mask is essential here.

In coordination with the prosthodontist, the prosthetic abutment is selected in the laboratory and adapted, where necessary, to the individual situation. The taper area must not be touched in this process.

### Remounting the sulcus former

Regardless of the method selected, after impression taking the Ankylos gingiva or sulcus former is remounted into the implant in order to avoid the collapse of the created gingival emergence point and to protect the implant lumen.



# Impression taking /X

Based on the friction-locked and keyed TissueCare connection, the Ankylos system concept offers both abutments with tapered connection geometry (C/ ) only and abutments which - in addition to the taper connection geometry- feature an additional prosthetic indexed ( /X).

Usage of indexed prosthetic components ( /X) requires not only the transfer of the implant position but also the transfer of the index orientation.

The indexed implant analog instruct the laboratory that indexed transfer components have been used. However, in case of necessity, non-indexed abutments (C/ ) can be used in an indexed implant analog.

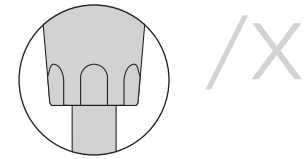

# Step-by-step: Impression taking /X (including index) on implant level



Ankylos /X transfer post (PickUp Technique), long and short and Ankylos PickUp Screw Extension



Ankylos /X transfer post (repositioning technique), long and short

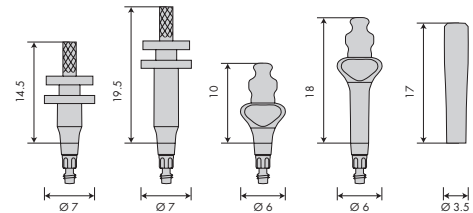

Diameters and heights

## Impressions for Ankylos abutments /X with open tray

- For transferring the implant position to the master cast using the PickUp technique (open tray)
- Available in two lengths
- One-piece with integrated straining screw, screw extension enclosed

## Impressions for Ankylos abutments /X with closed tray

- For transferring the implant position to the master cast using the repositioning technique (closed tray)
- Available in two lengths
- One-piece with integrated straining screw

## Step-by-step: Impression taking /X (including index)

The impression for prosthetic restorations on Ankylos X/ abutments is taken with indexed Ankylos X/ transfer posts favorably using the PickUp technique (open tray). Components for a transfer impression with repositioning technique (closed tray) are also available.

The following step-by-step guide describes both alternatives for restorations on non-indexed abutments. When using indexed Ankylos X/ abutments, impressions have to be taken with indexed transfer components to transfer the position of the index.

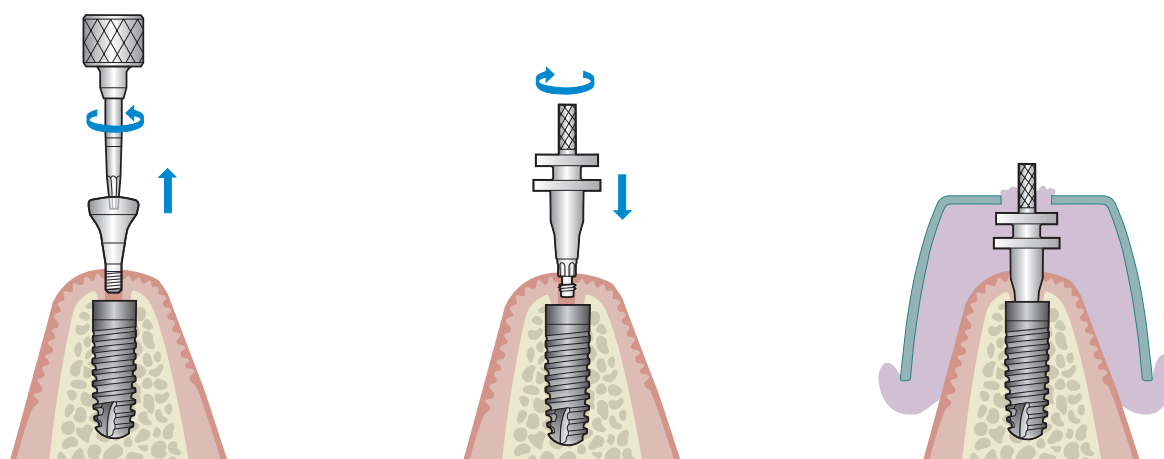

### Removing the sulcus former

Remove the Ankylos sulcus or gingiva former for the impression. The connection taper and the index of the implant must be cleaned of any tissue residue.

### Impression PickUp technique (open tray)

Depending on the position of the implant, insert the short or long Ankylos X/ transfer post into the connection taper and index of the implant and attach by using the integrated transfer screw. By doing so, hand-tighten the transfer screw at the knurled area. The internal hex in the screw head is an aid for releasing the screw. Please block this with wax prior to taking the impression.

The transfer post must be correctly fitted in the connection taper and the index of the implant otherwise the screw cannot be fastened. If necessary, the transfer screw can be provided with a screw extension to enable access for the screw.

The impression is taken using an open tray. After the impression material has set, undo the transfer screw and remove the impression. The PickUp transfer post remains in the impression. The impression is sent to the laboratory for casting the model. The production of a mucosa mask is essential here. In coordination with the practitioner, the prosthetic abutment is selected in the laboratory and adapted, where necessary, to the individual situation. The taper area must not be touched in this process.

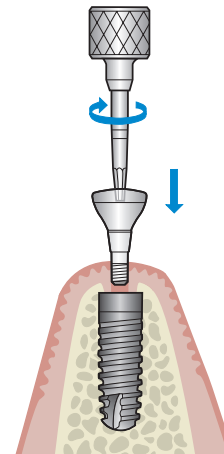
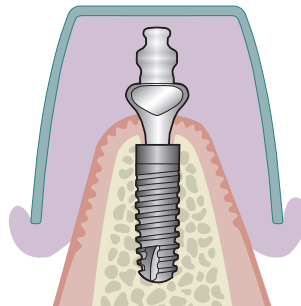
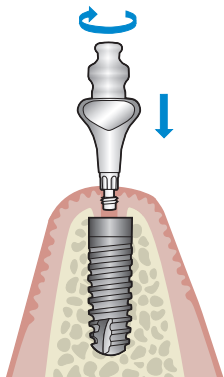
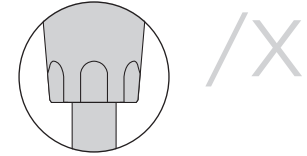

### Alternative: Repositioning technique (closed tray)

Depending on the position of the implant, insert the short or long Ankylos /X transfer post (repositioning technique) in the connection taper and index of the implant, align it according to the available space and attach by using the integrated transfer screw. The upper part of the retention is the screw-head. By doing so, make sure the index is properly positioned otherwise the screw cannot be fastened. Then hand-tighten the transfer screw. The internal hex in the screw head is an aid for releasing the screw. Please block this with wax prior to taking the impression.

The impression is taken using a closed tray. After the impression material has set, remove the

impression while the transfer post (repositioning technique) remains in the implant. Release the transfer post from the implant, connect it with an indexed implant analog and reposition it into the impression. Make sure that the flattened parts of the Ankylos /X transfer post are repositioned exactly. The impression with the transfer post is sent to the laboratory for casting the model. The production of a mucosa mask is essential here. In coordination with the prostodontist, the prosthetic abutment is selected in the laboratory and adapted, where necessary, to the individual situation. The taper area must not be touched in this process.

### Remounting the sulcus former

Regardless of the method selected, after impression taking the Ankylos gingiva or sulcus former is re-mounted into the implant in order to avoid the collapse of the created gingival emergence point and to protect the implant lumen.



# Balance Anterior C/ or /X

Ankylos Balance Anterior C/ and /X abutments are outstandingly suitable for your patients' restorations using single crowns and bridges optimally adjusted to periimplant conditions. With Ankylos Cercon Balance C/ abutments, you will achieve excellent esthetic results with the highest tooth analogy using all-ceramic single crowns in the anterior region.

The prosthetic abutments of the Balance range are available as freely positionable with tapered connection geometry (C/), Ankylos Balance Anterior abutments also with additional index serving as positioning aid (/X).



# Crowns and bridges on Ankylos® Balance Anterior C/ or /X, crowns on Cercon® Balance C/

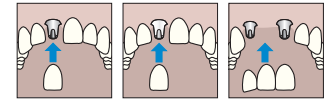

## Ankylos® Balance Anterior C/ or /X

- For esthetically demanding crowns and bridges in the anterior region
- Cemented or screw-retained
- Anatomical, customizable abutments made from titanium alloy Ti6Al4V
- With indexing or freely positionable

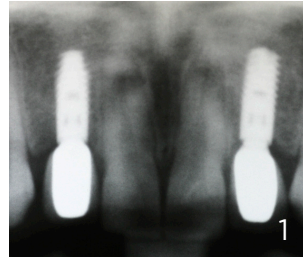

## Ankylos® Cercon® Balance C/

- For all-ceramic anterior crowns with the highest tooth analogy
- Cemented
- Freely positionable for utmost prosthetic flexibility
- Zirconium oxide for the highest stability
- Transparency, translucence and opalescence of natural teeth
- Reduced plaque adhesion compared to titanium abutments



1-3 | Single tooth replacement with Ankylos Balance Anterior C/ (courtesy of Dr. G. Trimpou and J.-H. Lee, MDT, Frankfurt/Germany).

4-7 | Single tooth replacement with Ankylos Cercon Balance C/ (courtesy of Dr. G. Trimpou, Frankfurt and A. Ludwig, MDT, Meckenheim/Germany).

All prefabricated Ankylos Balance prosthetic abutments are selected and customized in the dental laboratory.

## CAD/CAM prosthetic solutions

As an individual alternative to the prefabricated Ankylos Balance C/ and /X abutments, two solutions for patient-specific CAD/CAM-fabricated abutments are available:

- Ankylos TitaniumBase for the fabrication of esthetically high-quality ceramic abutments with prefabricated titanium core
- Atlantis abutments made of titanium, gold-shaded titanium or zirconia, the patient-specific one-piece solution for crowns.\*

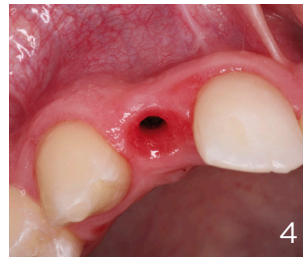

With the flexibility of patient-specific abutments, your restorations persuade with even more esthetics and functionality.

\* Available at: [www.atlantisweborder.com](http://www.atlantisweborder.com)

# Prosthetic components

## Ankylos® Balance Anterior C/ or /X

All prosthetic Ankylos C/X components are laser-marked to indicate their use:

- Components with the “C/” mark use only the “C”one for the connection and are not indexed. This means that the abutment components can be positioned as desired and are completely locked by the taper to prevent rotation.
- Components with the “/X” mark are indexed. The index is used to position the abutment components in one of six possible positions. In this case also, the taper guarantees optimum stability and rotation locking.

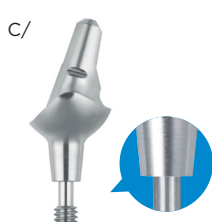

Ankylos Balance Anterior C/  
sulcus former with screw

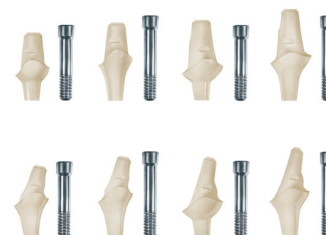

Ankylos Balance Anterior C/ temporary  
abutments made of plastic (PEEK) with  
zirconium oxide additive with screw

### Uncovery and soft tissue management

#### Ankylos Balance Anterior C/ Sulcus Former

- For straightforward contouring of the peri-implant soft tissues
- Selection in accordance with the gingival height
- Two sizes for optimal contouring of the tissues
- Customizable
- Two-piece with separate screw

Make sure to always use the final sulcus former corresponding to the selected abutment. Only this one guarantees for optimal soft tissue contouring and thus provides appropriate fit and stability for the prosthetic abutment.

#### Ankylos Balance C/ Temporary Abutment

- For esthetically demanding temporary crowns and bridges
- Easily adaptable to the clinical situation with two diameters (large and small), two gingival heights (1.5 and 3.0 mm) and two angulations (0° and 15°)
- Large abutment can be customized by grinding
- Two-piece with separate screw
- Stable and radiopaque thanks to the zirconium oxide additive

The temporary denture can be worn for a maximum of 6 months.

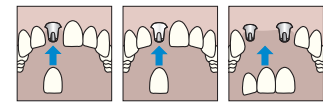

#### Diameters and head heights

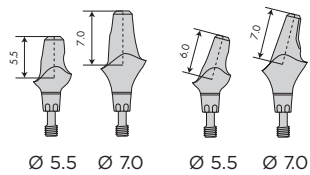

#### Angulations and gingiva heights

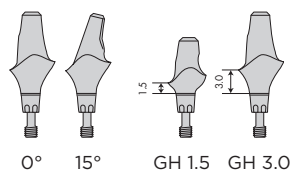

Dimensions of the Ankylos Balance Anterior C/ and /X abutment as well as of the Cercon Balance C/ abutment [mm]

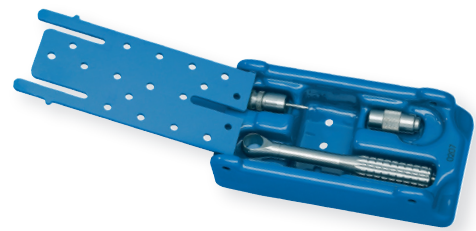

Ankylos Prosthetic Tray mini

### Instruments

For prosthetic restorations on Ankylos Balance Anterior C/ or /X or Cercon Balance C/ abutments, only the 1.0 mm hex screwdriver is needed. Together with the ratchet and a mounting device, this is available as an insert for the prosthetic ratchet in the Ankylos Prosthetic Tray mini.

# Crowns and bridges

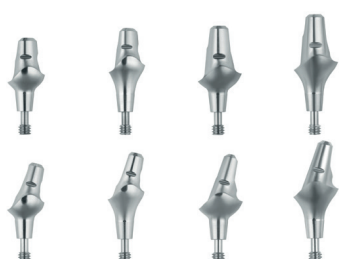

Ankylos Balance Anterior C/ abutment made of titanium alloy

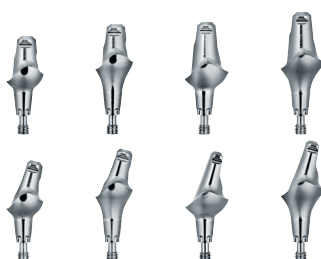

Indexed Ankylos Balance Anterior /X abutment made of titanium alloy



Ankylos Cercon Balance C/ abutment made of zirconium oxide

## Prosthetic restoration

### Ankylos Balance Anterior C/ or /X Abutment

- For esthetically demanding crowns and bridges in the anterior region
- With indexing (/X) or freely positionable (C/)
- One-piece with integrated straining screw
- Easily adaptable to the clinical situation with two diameters (large and small), two gingival heights (1.5 and 3.0 mm) and two angulations (0° and 15°)
- Can be customized by grinding
- Cementable or laterally screw-retained with M 1.4 fixation screw lateral hexagon (red, order no. 3105 6301)

### Ankylos Cercon Balance C/ Abutment

- For all-ceramic crowns with the highest tooth analogy in the anterior region
- Manufactured of zirconium oxide for the highest stability
- Easily adaptable to the clinical situation with two diameters (large and small), two gingival heights (1.5 and 3.0 mm) and two angulations (0° and 15°)
- One-piece with integrated straining screw
- Large abutment can be customized by grinding, small abutment cannot be further reduced

- Two shades of white: neutral and dentine
- Superior esthetics due to brilliant light dynamics
- Cementable

The indication for Cercon abutments is limited to single tooth restorations in the anterior region.



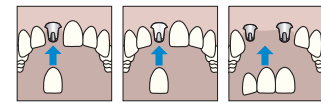

For the insertion of the sulcus former, please always adhere to the basic guidelines for soft tissue management on page 20.

### Ankylos Balance Anterior C/

### Ankylos Balance Anterior /X

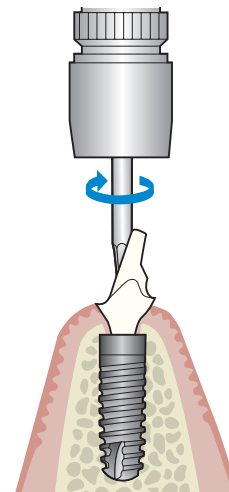
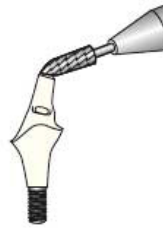
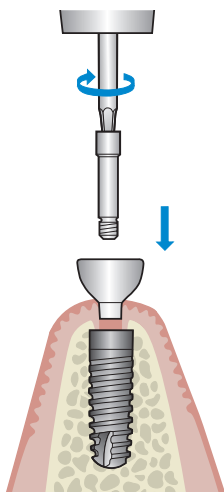

#### Inserting the Ankylos Balance Anterior C/ sulcus former

The Balance Anterior C/ sulcus former is a two-piece component. It allows customization and fixation in the desi-red position. Select the sulcus former corresponding to the mucosal thickness and the diameter of the designated abutment. Insert the screw with the internal hex through the hole in the sulcus former and tighten hand-tight in the internal implant thread using the 1.0 mm hex screwdriver. Sterilize the sulcus former prior to use (see Instructions for sterilization and instrument care). The same sulcus formers are used for straight and angled abutments. These will remain in situ for approx. 14 days.

#### Short-term provisional

The Ankylos Balance C/ temporary abutment can be used to fabricate a short-term provisional, both in the anterior and in the posterior region. The large Ankylos Balance C/ temporary abutment may not be reduced to less than the size of the small Balance C/ temporary abutment. Crosscut hard-metal milling tools with up to 25,000 rpm are used for the grinding. Grinding should be performed outside the mouth. The small Balance C/ temporary abutment may not be ground. Prior to placement, clean the implant connection taper with an air-water spray and dry.

The abutment is screw-retained at 15 Ncm using the prosthetic ratchet and the 1.0 mm hexagonal torque insert or a torque-controlled contra-angled handpiece with 1.0 mm hex screwdriver insert. Cement the suprastructure with temporary cement. Thoroughly remove excess cement on the crown margin.

Ankylos Balance C/ short-term provisionals must be replaced after no longer than six months.

# Step-by-step: Delivery of the prosthetic restoration

Both cemented and laterally screw-retained crowns and bridges can be fabricated on titanium alloy Ankylos Balance Anterior C/ or /X abutments.

All-ceramic single-tooth restorations on Ankylos Cercon Balance C/ abutments must always be cemented.

## Ankylos Balance C/

## Ankylos Balance C/

## Ankylos Balance /X

## Ankylos Balance /X

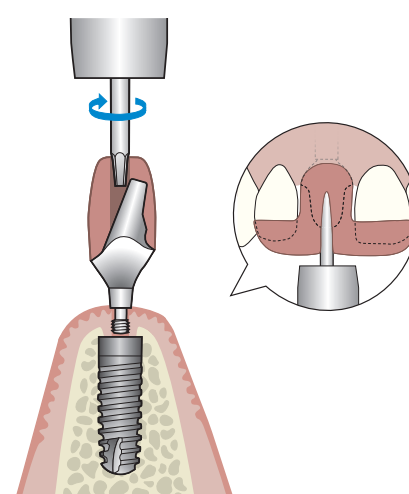
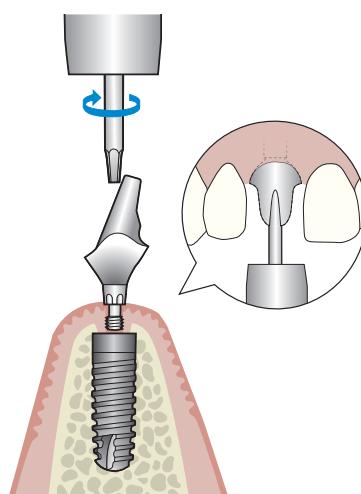
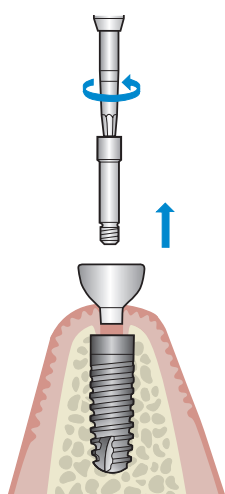

Remove the prosthetic restoration supplied by the laboratory from the model and unscrew the abutment from the implant analog in the model. Clean and sterilize the abutment.

Unscrew the Ankylos Balance Anterior C/ sulcus former or the provisional from the implant and clean the connection taper of the implant using an air-water spray and dry thoroughly with an air spray.

Please have short and long 15 Ncm torque wrenches ready for different sizes of transfer keys.

### Inserting Ankylos Balance/X abutments

Screw the Ankylos Balance /X abutment into the implant in the same index position as defined in the master cast. Use the torque wrench with 1.0 mm hex insert or a torque-controlled contra-angle handpiece. The recommended torque for the straining screw is 15 Ncm.

For fitting the index, the contoured gingiva has to match with the geometry of the abutment. For better handling, the use of a transfer key could be helpful for indexed abutments as well.

### Inserting Ankylos Balance C/ abutments

Position the Ankylos Balance C/ abutment or the Ankylos Cercon Balance abutment in the implant with the aid of the laboratory-fabricated transfer key and screw it in place. Use the torque wrench with 1.0 mm hex insert or a torque-controlled contra-angle handpiece. The recommended torque for the straining screw is 15 Ncm.

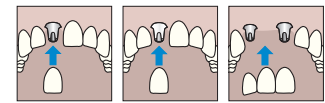

Ankylos Balance C/

Ankylos Balance /X

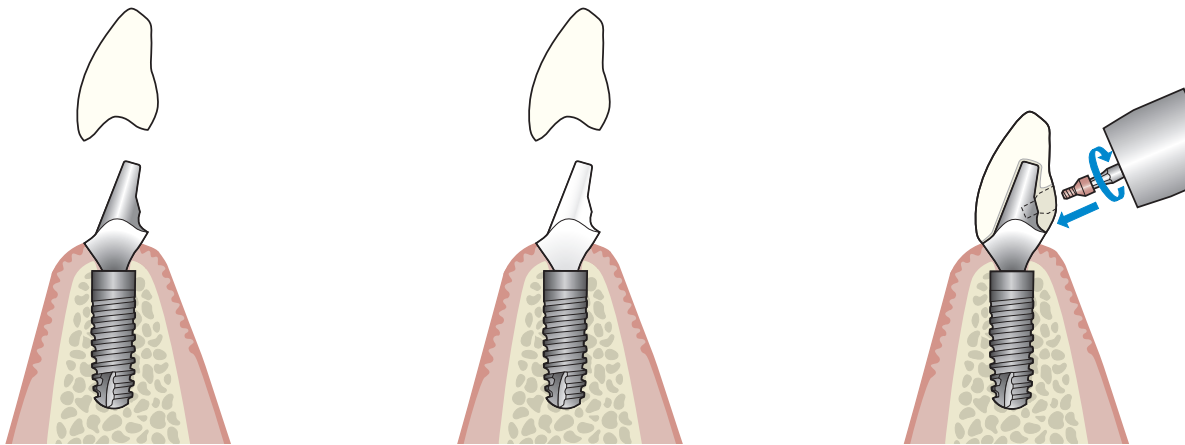

### Placing the suprastructure

Check the fit of the crown or bridge on the inserted abutment. Clean and disinfect the suprastructure. The suprastructure can be cemented or laterally screw-retained. All-ceramic crowns and crowns with ceramic shoulders should always be cemented.

**Cementing the titanium abutment:** Phosphate cements can be used for cementation. Ensure here that excess cement is thoroughly removed from the crown margin. The upper two thirds of the abutment is roughened when cementing with temporary cement.

### Cementing the all-ceramic abutment:

Suprastructures with Cercon frameworks can be cemented conventionally with zinc oxide-phosphate cements in the appropriate color. Ensure here that excess cement is thoroughly removed from the crown margin. Pressed ceramic suprastructures, e.g. Cergo crowns, can also be mounted using zinc oxide-phosphate cement or adhesive, although not using glass ionomer cement. The abutment surface provided for cementing must be roughened using diamond burs (e.g. shaping after customization).

Special surface conditioning (silanization, etc.) is not required. Always observe the manufacturer's directions for the all-ceramic restoration system used.

### Screw retention:

When screw-retaining (titanium abutments only), screw the crown onto the abutment with a torque of 10 Ncm using the red M 1.4 mm lateral fixation screw (order no. 3105 6301) supplied by the laboratory.

# TitaniumBase C/ or /X

## The foundation for perfect patient-individual esthetics: Ankylos<sup>®</sup> TitaniumBase

With the individual abutment Ankylos TitaniumBase by Dentsply Sirona Implants the dental technician is able to manufacture esthetically high-quality ceramic abutments with titanium cores.

These allow for the fabrication of highly individual restorations that are as close as possible to the natural esthetics of the anterior and posterior regions.



Ankylos TitaniumBase /C and /C high and Ankylos ScanBase /C and /C high

Ankylos TitaniumBase /X and /X high and Ankylos ScanBase /X and /X high

### Precision and individuality

Ankylos TitaniumBase abutments provide the security of a pre-fabricated titanium TissueCare taper connection combined with a highly individual porcelain abutment design.

For an optimal prosthetic result, the Ankylos TitaniumBase is provided with two flattened sides forming a rotation lock

### Controllable, highly esthetic result

Each work stage for a perfect overall prosthetic result is controlled by the dental technician. The individual section of the abutment is waxed-up by hand, without the need for design software.

With the glueing of the titanium core to the ceramic outside the patient's mouth, adhesive residues can be removed without difficulty. For easy shaping of a customized emergence profile, the TitaniumBase can be used as a customized gingiva former after uncovering of the implant.





#### Diameters and head heights

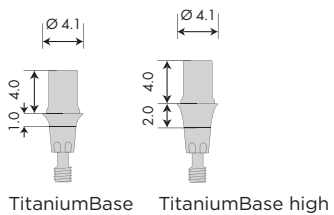

Dimensions of the Ankylos TitaniumBase C/ and /X abutment [mm]

### Uncomplicated processing, regardless of software and equipment

Scanning in the abutment geometry is simplified with the aid of Ankylos ScanBase. This can be used with all common dental scanners.

Thanks to its analog scan design, you don't need to use scan spray or powder in this step. The individually waxed-up abutment model is created virtually using the double scan technique and is milled in ceramic.

# Step-by-step: Ankylos® TitaniumBase Abutment

The customizable Ankylos TitaniumBase Abutment enables the dental technician to manufacture esthetic, high-quality ceramic abutments with a titanium core.

These allow for fabrication of patient-specific restorations which come as close as possible to the natural esthetics in both the anterior and posterior region.

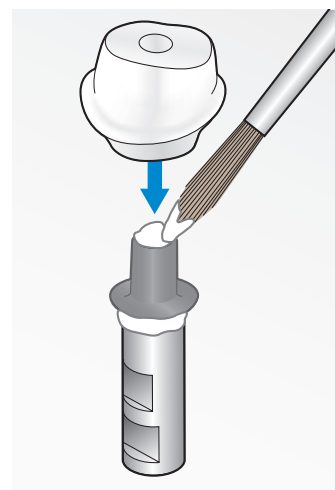
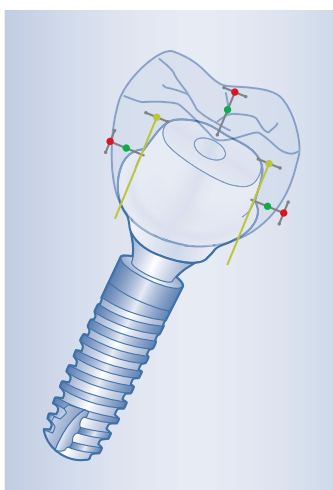
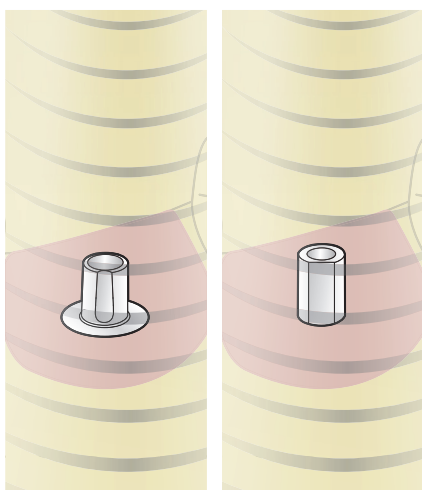

## Impression taking and the scanning procedure

Expose the implants in case of sub-merged healing. Remove the Cover Screw or gingiva-forming components and take impressions as described starting on page 24. Mount/remount the Gingiva Former after impression taking. The laboratory receives the impression for casting the model.

In the dental laboratory, the model is scanned with/without the mounted scan post. Use scanspray for gingival masks to ensure an accurate scan. For restorations with more than four teeth, an additional wax-up scan should be made.

## Design

Design the ceramic part according to anatomical preferences. The finished CAD-designed customized abutment with the virtual TitaniumBase can now be manufactured.

The fine tuning of the abutment design should be based on the preparation guidelines for natural teeth as well as on the guidelines for the materials being used.

The created STL data set, the basis for the fabrication of the individual mesostructure, can either be locally milled or sent to any desired dental milling facility.

## Fixation of the TitaniumBase

After blasting with aluminum oxide and pre-treating with a metal primer, the TitaniumBase is to bond with the individually milled ceramic abutment with a suitable adhesive, according to the instructions of the adhesive manufacturer. For optimal positioning, the fabrication of a transfer key is recommended.

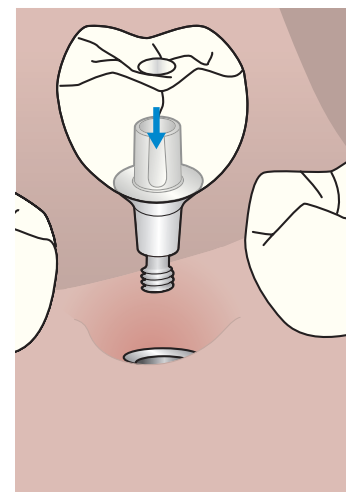
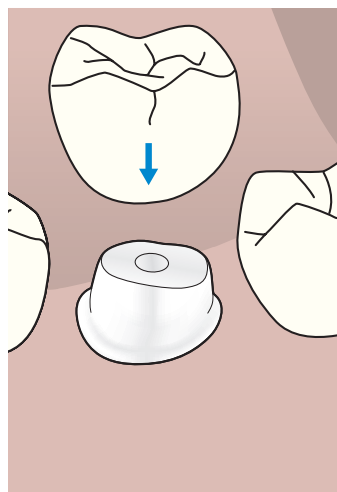
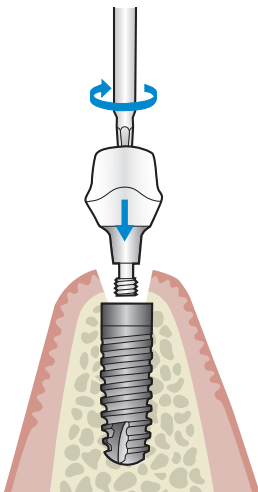
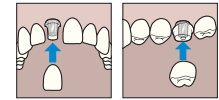

### Placing the TitaniumBase Abutment

Place the individual TitaniumBase Abutment in the implant with the index position as determined in the model.

The TitaniumBase Abutment is to tighten with the abutment screw at 15 Ncm using the prosthetic ratchet and the Hex Driver 1.0 mm or a torque-controlled contra-angle handpiece with the respective driver insert.

### Final restoration

Place the final zirconia crown on the individual TitaniumBase Abutment and cement it intraorally. When doing so, take care to remove excess cement completely from the crown margins.

For the manufacture of bridge constructions, the same procedure is used as for single crowns.

### Ankylos TitaniumBase screw-retained crown

Alternatively, the full contour crown or veneered crown can be produced and bonded onto the TitaniumBase for the single tooth screw-retained restoration.

In this case, after removing the Gingiva Former, the final crown is to tighten with the abutment screw at 15 Ncm using the prosthetic ratchet and the Hex Driver 1.0 mm or a torque-controlled contra-angle handpiece with the respective driver insert.

# Atlantis<sup>®</sup> abutments

## Unique originals for unique individuals

As a part of the digital solutions offering from Dentsply Sirona Implants, Atlantis abutments support cement-, screw- and attachment-retained restorations for all major implant systems, providing an excellent foundation for optimal function and esthetics.

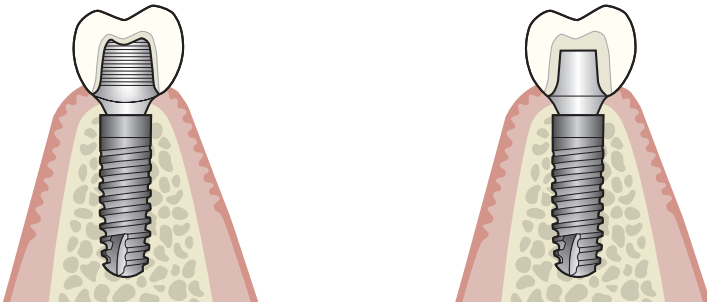

**Atlantis abutments are patient-specific abutments, designed to fit the individual patient's anatomy.**

Each abutment is individually designed in Atlantis VAD, from the final tooth shape taking the specific edentulous space, surrounding teeth and soft tissue anatomy into consideration.

Taking these factors into account produces implant prosthetics that mimic true natural tooth function and appearance.

**Cement-retained restorations Atlantis Abutment is a uniquely designed, patient-specific abutment for cement-retained restorations.**

Margins are ideally designed and placed for easy and safe removal of excess cement and the abutments can be installed using the Atlantis Abutment Insertion Guide.

This ensures efficient restorative procedures, reducing chairtime. Ordering is simple and requires only a standard impression sent to the dental laboratory with a request for an Atlantis Abutment.

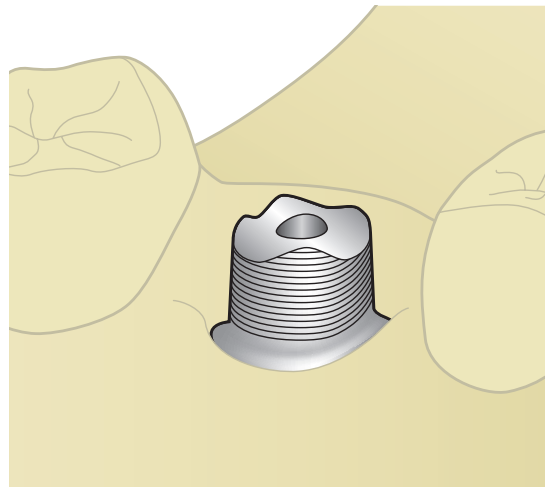
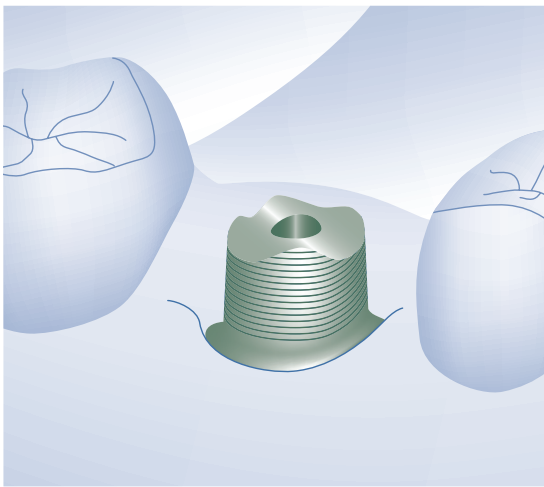

### **Atlantis Abutment Core File**

The digital file of the total case, including the outer surface of the Atlantis Abutment, allows the dental laboratory to design a temporary or final crown even before the final Atlantis Abutment is delivered.

# Step-by-step: Atlantis<sup>®</sup> patient-specific abutments

Atlantis patient-specific abutments are available in biocompatible materials including titanium, gold-shaded titanium (titanium nitride coated - TiN) and different shades of zirconia for esthetically demanding cases.

Atlantis VAD (Virtual Abutment Design) is an expert system software that designs abutments entirely in a virtual environment. It's smart software that can take all of the information input and transform it into an initial abutment design.

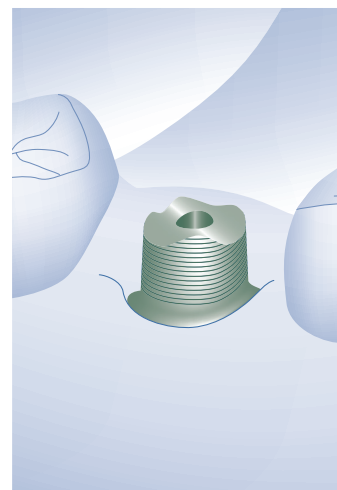
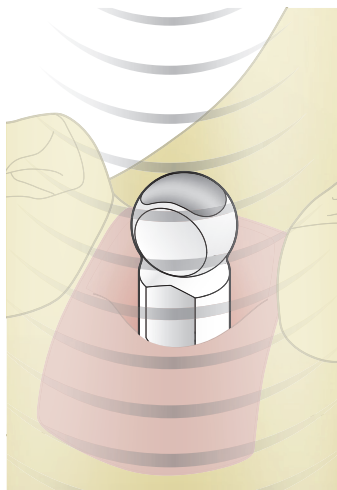
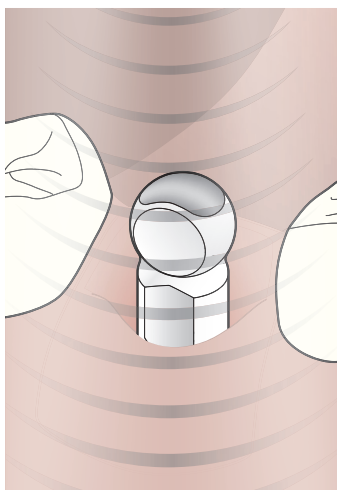

## Dental practice

Take a digital implant-level impression with an intraoral scanner and Atlantis IO FLO. Analyze the digital file and transmit the file to the dental laboratory with a request for an Atlantis Abutment.

As an alternative, take a precise traditional implant-level impression and send the materials to your dental laboratory with a request for an Atlantis Abutment.

## Dental laboratory

Review the digital file or use the traditional impression to create the master cast, including a gingiva mask. Either scan the master cast at the dental laboratory or send it to the Dentsply Sirona Implants production facility. Submit the order in Atlantis WebOrder for design and production.

## Abutment design

The Atlantis Abutment is designed at Dentsply Sirona Implants, using the Atlantis VAD software. The software makes it possible to design each abutment in relation to the edentulous space and the surrounding teeth. The abutment design can be reviewed and approved by the dental technician in Atlantis 3D Editor before production.

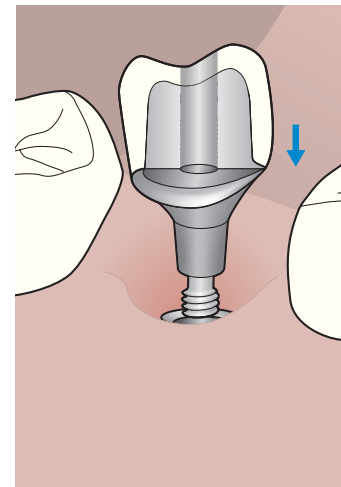
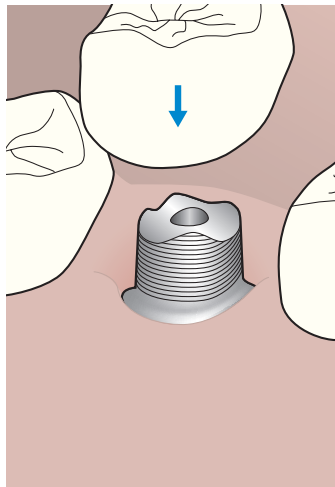
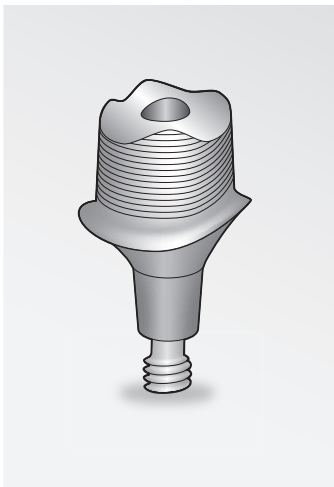
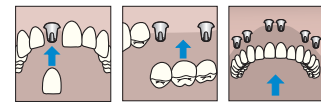

### Final restoration

The Atlantis Abutment with the abutment screw is delivered to the clinician.

Additional modification of the Atlantis Abutment is not recommended.

### Abutment installation

The Abutment is to tighten with the abutment screw at 15 Ncm using the prosthetic ratchet and the Hex Driver 1.0 mm or a torque-controlled contra-angle handpiece with the respective driver insert.

Clean and disinfect all components. Metal crowns can be cement-retained or screw-retained. All-ceramic crowns or crowns with a ceramic shoulder should always be cemented.

### Atlantis Crown Abutment

The Atlantis Crown Abutment is indicated for single tooth, screw-retained restorations. It is an efficient, effective and esthetic alternative to traditional cast abutments. Porcelain or composite can be applied directly onto the abutment and the abutment design supports the veneering material. The Atlantis Crown Abutment is available in titanium (grade 5) and in five shades of zirconia.

For more information, refer to the Design guide - Atlantis patient-specific abutments.

For the manufacture of bridge constructions, the same procedure is used as for single crowns. Bridge constructions on individual abutments can only be cemented.



# Regular C/ and /X Balance Posterior C/

The Ankylos Regular C/ and /X prosthetic range enables the fabrication of functionally and esthetically appealing reconstructions for edentulous gaps and free ends with single crowns or an implant-supported bridge. With their convex sulcus design, Ankylos Regular C/ and /X abutments have been optimized for the posterior region.

Choose between two options: the tapered TissueCare connection, with freely positionable components, or components with the tapered TissueCare connection and additional indexing as an aid to positioning.

Smaller in design Balance Posterior C/ abutments are used for similar cases and follow the same working steps. Balance Posterior C/ abutments are offered only with the tapered TissueCare connection for free positioning.



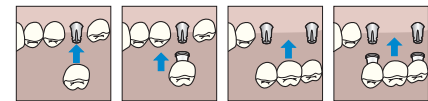

# Crowns and bridges on Ankylos® Regular C/ or /X

## Classic Ankylos® Regular C/ or /X procedure

- For esthetically demanding results
- Transfer the implant position for the laboratory with the transfer post
- Selection of the prosthetic abutment made from titanium alloy Ti6Al4V in the dental laboratory
- The suprastructure is fabricated on the original abutments
- Can be customized
- Cemented or screw-retained suprastructures



## Simplified procedure using Ankylos® Regular C/X 3-in-1 cap

- Not changing abutment components means simplified handling and optimal patient comfort
- Less irritation of the soft tissues
- Selection of the prosthetic abutment at the chairside
- The impression of the abutment position for the laboratory is taken via the 3-in-1 cap
- The suprastructure is fabricated on the 3-in-1 cap
- Cannot be customized
- Cemented suprastructures only
- Provisional restoration at the chairside is also simplified for the patient via the 3-in-1 cap



## CAD/CAM prosthetic solutions

As an individual alternative to the prefabricated Ankylos Regular C/ and /X abutments, two solutions for patient-specific CAD/CAM-fabricated abutments are available:

- Ankylos TitaniumBase for the fabrication of esthetically high-quality ceramic abutments with prefabricated titanium core
- Atlantis abutments made of titanium, gold-shaded titanium or zirconia, the patient-specific one-piece solution for crowns.\*

With the flexibility of patient-specific abutments, your restorations persuade with even more esthetics and functionality.



1-3 | Replacement tooth 13 with Regular /X abutment (courtesy of Dr. Orcan Yüksel, Frankfurt/Germany).

\* Available at: [www.atlantisweborder.com](http://www.atlantisweborder.com)

# Prosthetic components Ankylos® Regular C/ or /X, Ankylos® Balance Posterior C/

All prosthetic Ankylos C/X components are laser-marked to indicate their use:

- Components with the “C/” mark use only the “C”one for the connection and are not indexed. This means that the abutment components can be positioned as desired and are completely locked by the taper to prevent rotation.
- Components with the “/X” mark are indexed. The index is used to position the abutment components in one of six possible positions. In this case also, the taper guarantees optimum stability and rotation locking.
- Components with the C/X mark are used for indexed or non-indexed prosthetics.

C/



/X



Ankylos Regular C/X Gingiva Former (above) and Ankylos Balance Posterior C/ Sulcus Former (below)

Regardless of whether a prosthetic restoration on indexed Ankylos Regular /X abutments or on the freely positionable Ankylos Regular C/ abutments and Ankylos Balance Posterior C/ Abutment is planned, the identical components with the C/X marking are used for contouring the soft tissues and for the impression.

## Uncovery and soft tissue management

### Ankylos Regular C/X Gingiva Former

### Ankylos Balance Posterior C/ Sulcus Former

- For simple contouring of the peri-implant soft tissue
- Selection in accordance with the gingival height
- One-piece with integrated thread

Make sure to always use the final sulcus former corresponding to the selected abutment. Only this one guarantees for optimal soft tissue contouring and thus provides appropriate fit and stability for the prosthetic abutment.

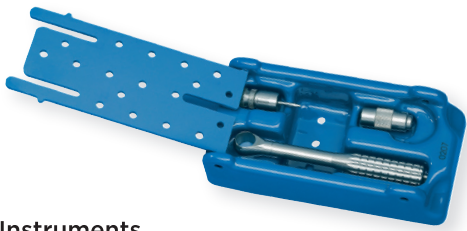
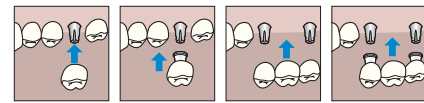

## Instruments

For prosthetic restorations on Ankylos Regular C/ or /X abutments resp. Ankylos Balance Posterior C/ Abutment, only the 1.0 mm hex screwdriver is needed. Together with the ratchet and a mounting device, this is available as an insert for the prosthetic

ratchet in the Ankylos Prosthetic Tray mini. For further screwdriver variants for manual use, ratchet or contra-angle handpiece, see Ankylos Product Catalog.

### Diameters and head heights

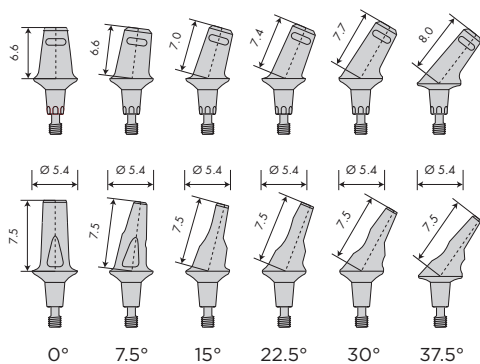

Ankylos Regular C/ or /X abutment (above) and Ankylos Balance Posterior C/ abutment (below) dimensions [mm]

### Gingival heights and diameters

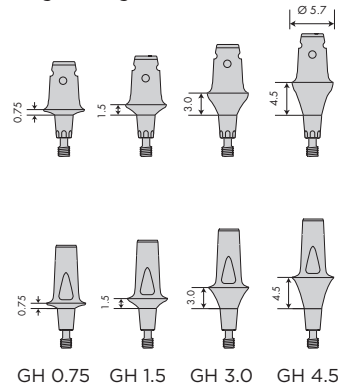

Ankylos Regular C/X 3-in-1 caps

## Prosthetic restoration

### Ankylos Regular /X or Regular C/ Abutment

### Ankylos Balance Posterior C/ Abutment

- Freely positionable (C/) or with indexing (/X)
- One-piece with integrated straining screw
- Easily adaptable to the clinical situation with four gingival heights (0.75/1.5/3.0/4.5 mm) and up to six angulations (0°/7.5°/15°/22.5°/30°/37.5°)
- Can be customized by grinding
- Cementable or laterally screw-retained
- Cannot be cast, cannot be fired

## Prosthetic restoration

Abutments with a gingival height of 0.75 and 1.5 are intended for use with primarily thin gingiva. When using these abutments with thicker gingiva, they could compromise the establishment of the biological width and thus peri-implant bone stability.

## Simplified procedure on the abutment level

### Ankylos Regular C/X 3-in-1 Cap

(for Regular C/ or /X abutment only)

- Using 3-in-1 caps the abutment must not be modified

### Impressions:

- For transferring the position of the prosthetic abutment to the master cast when taking the impression over unmodified Ankylos Regular C/X abutments already located in the implant

### Temporary restorations:

- For fabricating a temporary restoration chairside with snap connection (on unground abutments only)

### In the laboratory:

- As a wax-up coping on implant analogs and unground abutments

# Step-by-step: Delivery of the prosthetic restoration

Depending on whether the suprastructure was fabricated on indexed Ankylos Regular /X abutments or on the freely positionable Ankylos Regular C/ abutments, the prosthetic abutments are positioned

using the index as a positioning aid or with a laboratory-fabricated transfer key. The following step-by-step instructions describe both methods.

## Ankylos Regular C/

## Ankylos Regular C/

### Ankylos Regular /X

### Ankylos Regular /X

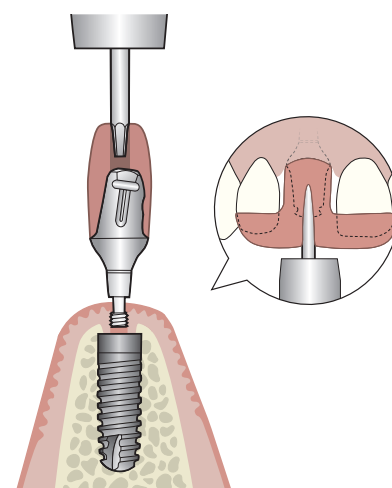
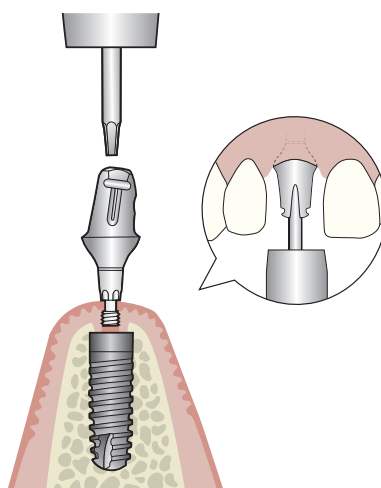
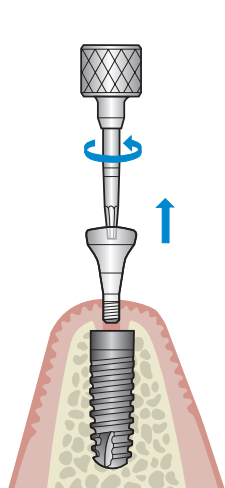

Remove the prosthetic restoration supplied by the laboratory from the model and unscrew the Ankylos Regular /X or C/ abutment from the analog in the master cast. Clean and sterilize the abutment.

Unscrew the Ankylos Regular C/X gingiva former from the implant and clean the connection taper and index of the implant using an air-water spray and dry thoroughly with an air spray.

### Inserting Ankylos Regular /X abutments

Screw the Ankylos Regular /X abutment into the implant in the same index position as defined in the master cast. Use the torque wrench with 1,0 mm hex insert or a torque-controlled contra-angle handpiece. The recommended torque for the straining screw is 15 Ncm.

For fitting the index, the contoured gingiva has to match with the geometry of the abutment. For better handling, the use of a transfer key could be helpful for indexed abutments as well.

### Alternative: Inserting Ankylos Regular C/ abutments

Position the Ankylos Regular /C abutment in the implant with the aid of the laboratory-fabricated transfer key and screw it in place. Use the torque wrench with 1,0 mm hex insert or a torque-controlled contra-angle handpiece. The recommended torque for the straining screw is 15 Ncm.

Please have a short and long 15 Ncm torque wrenches ready for different sizes of transfer keys.

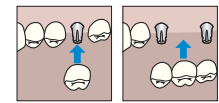

Ankylos Regular C/

Ankylos Regular /X

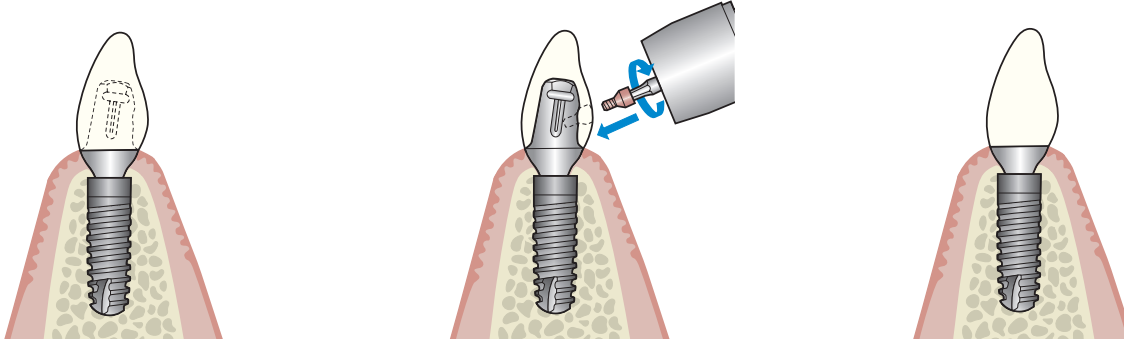

### Placing the suprastructure on Ankylos Regular /X or C/

Check the fit of the suprastructure on the inserted Ankylos Regular /X or Regular C/ abutment. Clean and disinfect the suprastructure.

The suprastructure can be cemented or laterally screw-retained. All-ceramic crowns or crowns with ceramic shoulders should always be cemented-in. Remove excess cement thoroughly after cementing.

For screw-retained restorations, screw the crown or bridge to the abutment using the red Ankylos M 1.4 lateral fixation screw (order no. 3105 6301, anodised in red) supplied by the laboratory at a torque of 10 Ncm.

In case you decided for a restoration on patient-specific Atlantis CAD/CAM abutments, the integration of the abutments and suprastructure (cement-retained only) is also performed as described here.

## Step-by-step: Simplified procedure on the abutment level

In contrast to the procedure described before, where the prosthetic abutments are selected by the dental laboratory in collaboration with the practitioner, the selection and incorporation of the abutments after soft tissue healing here takes place directly at the chairside. Once incorporated, the abutments remain in the patient's mouth.

Following transgingival implant healing or with immediate restoration using a short-term provisional, uncover and soft tissue healing are not required. The abutments are selected and incorporated immediately.

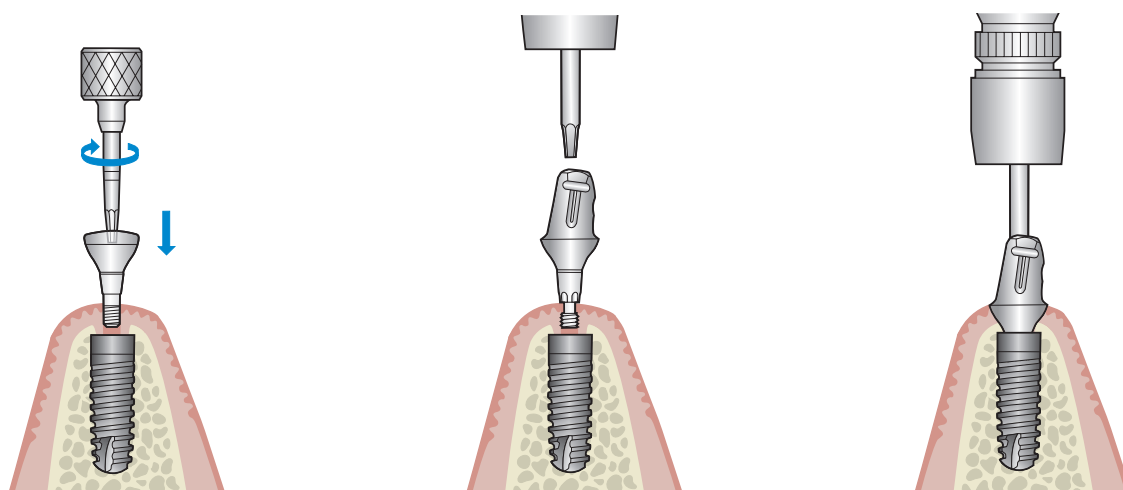

### Inserting the Ankylos Regular C/X gingiva former

The Ankylos Regular C/X gingiva former is a one-piece component. Select the Regular C/X gingiva former corresponding to the mucosal thickness and screw it hand-tight into the internal thread of the implant using the 1.0 mm hex screwdriver.

Sterilize the gingiva former prior to use (see Instructions for sterilization and instrument care). The same Regular C/X gingiva formers are used for straight and angled abutments. These will remain in situ for approx. 14 days. Especially when working with indexed components, correct and sufficient soft tissue contouring is essential.

### Select and insert the Ankylos Regular C/X abutment

Remove the Ankylos Regular C/X gingiva former. The connection taper and the index of the implant should be cleaned of any tissue residues.

Select the suitable straight or angled Ankylos Regular C/ or /X abutment according to the anatomical situation and align this in the implant. To fit the index, it is important that the contoured gingiva corresponds with the geometry of the abutment. Sterilize the Ankylos Regular C/ or /X abutment prior to use (see Instructions for sterilization and instrument care).

Screw-retain the Ankylos Regular C/ or /X abutment in the implant. A torque-wrench or a torque-controlled contra-angle handpiece with a 1.0 mm hex insert should be used for the screw-retention. The recommended torque for the straining screw is 15 Ncm.

When using this procedure, the Ankylos Regular C/ and /X abutments must on no account be ground.

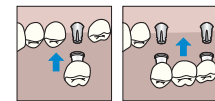

Ankylos Regular C/X 3-in-1 caps are single-use articles; multiple usage will affect the precision. Regular C/X 3-in-1 caps may not be sterilized.

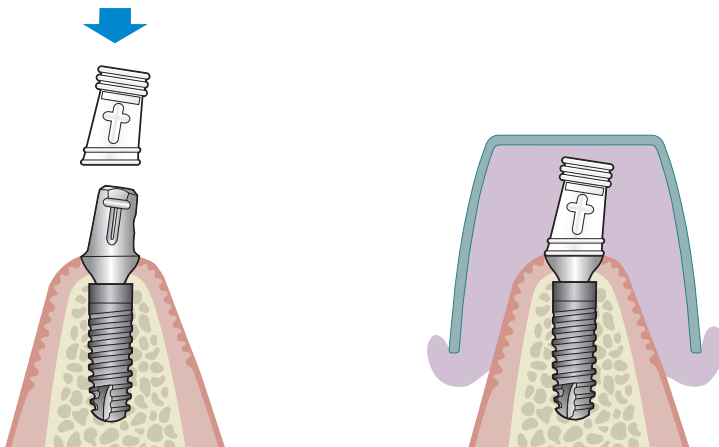

### Taking the impression with the Ankylos Regular C/X 3-in-1 cap

To transfer the position of the prosthetic abutment onto the master cast, the multifunctional Ankylos Regular C/X 3-in-1 cap is placed on the Ankylos Regular /X or Regular C/ abutments already fixed in the implant. Select the 3-in-1 cap suitable for the angulation of the Ankylos Regular C/ or /X abutment\*. The integrated snap mechanism guarantees secure positioning of the caps on the abutments.

The impression is taken using a closed tray. Remove the impression after the impression material has set. Since the Ankylos Regular C/X 3-in-1 cap remains in the impression, hydrocolloid cannot be used as the impression material.

The impression is sent to the laboratory for casting the model.

\* Caps only available up to 22.5°

## Step-by-step: Simplified procedure on the abutment level

After the impression is taken, the Ankylos Regular C/ or /X abutment remains in the patient's mouth. Subsequently, a provisional can be fabricated directly at the chairside as a temporary measure while the

definitive crown or bridge is fabricated in the laboratory. The 3-in-1 cap is also used for this procedure.

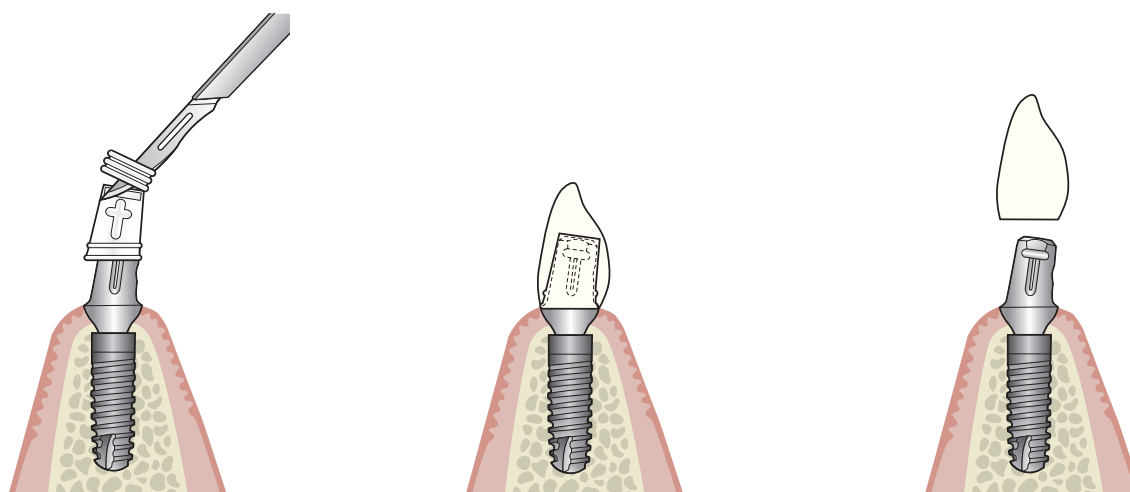

### Fabricating a temporary restoration

Select the Ankylos Regular C/X 3-in-1 cap suitable for the abutment angulation\* and, in this case, remove the retention ring on the tapered section. Roughen the surface of the temporary cap in order to obtain better adhesion on the synthetic material.

While working directly in the patient's mouth, place a suitable cap on the abutment and build up the tooth cast with synthetic material, e.g. using a splint fabricated in the laboratory. For reasons of stability, an adequate wall thickness should be ensured. By and large, the provisional should match the definitive restoration.

For screw-retained provisionals, drill out the small lateral marking and fabricate the temporary denture using the red M 1.4 lateral fixation screw.

\* Caps only available up to 22.5°

### Delivery of the prosthetic restoration

Remove the temporary restoration from the Ankylos Regular C/ or /X abutment. Clean the abutment using an air-water spray and dry thoroughly using an air spray.

Short-term provisionals fabricated using the Ankylos Regular C/X 3-in-1 cap must be replaced after not longer than 30 days.



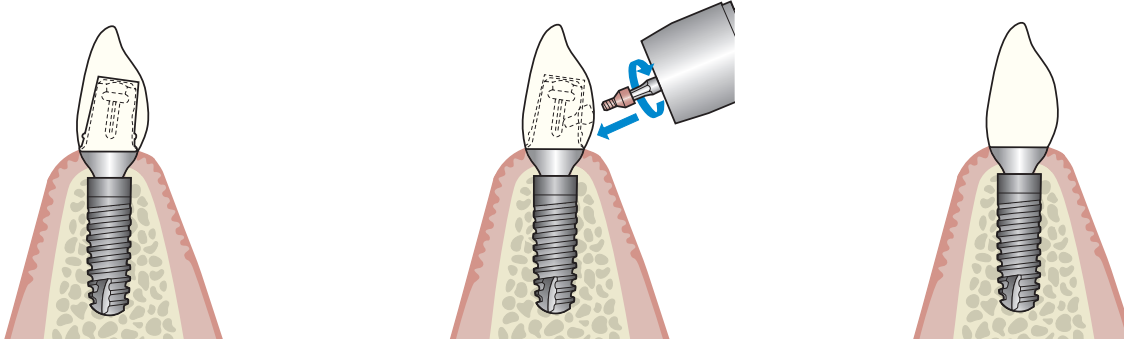
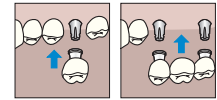

### Placing the suprastructure on Ankylos Regular /X or C/

Remove the prosthetic restoration supplied by the laboratory from the model and check the fit on the Ankylos Regular /X or Regular C/ abutment. Clean and disinfect the restoration. The suprastructure can be cemented or laterally screw-retained.

All-ceramic crowns and crowns with ceramic shoulders should always be cemented. Thoroughly remove excess cement after cementing.

Where the crown is screw-retained onto the abutment, the red Ankylos M 1.4 lateral fixation screw (order no. 3105 6301) supplied by the laboratory should be used at a torque of 10 Ncm.



# Balance Base C/ narrow SmartFix concept

With the Ankylos Balance Base Abutment C/ narrow you will be able to provide your edentulous and partially edentulous patients with screw-retained bridges and removable overdentures on bars. The suprastructure is manufactured conventionally in the dental laboratory or centrally as an Atlantis implant suprastructure.

Rotationally symmetrical Ankylos Balance Base Abutments made of titanium alloy Ti6AlV are available with tapered connection geometry. Due to the rotational symmetry, indexing is not required.

In combination with angled Balance Base abutments the usage is extended into the SmartFix concept:

The SmartFix concept is an implant-prosthetic procedure for the immediate restoration of edentulous patients with screw-retained bridges or bar dentures in the maxilla and mandible.

To obtain a common insertion direction, the implants placed in an angle are provided with 15° or 30° angled Ankylos Balance Base abutments.

Two procedures of fabrication can be selected for prosthetic restorations: Either the conventional fabrication of a suprastructure or CAD/CAM-fabricated Atlantis suprastructures with a high precision fit.

The implant prosthetic procedure for the immediate restoration with angled implants in edentulous patients

- provides stable prosthetic fit
- avoids critical anatomical areas by using angled implants

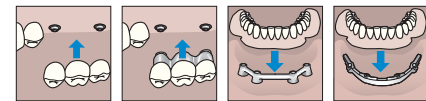

## Bar-supported overdentures and bridges with Ankylos® Balance Base Abutment C/

### Laboratory-fabricated restorations with Ankylos® Balance Base Abutment C/

- Overdentures on laser welded or soldered bars in the implants
- Screw-retained bridges with ceramic or synthetic veneering for edentulous or partially edentulous jaws
- Prefabricated components facilitate a simplified procedure

### Atlantis implant suprastructures on Ankylos® Balance Base Abutment C/

- Atlantis bar reconstructions and bridgework with centrally fabricated CAD/CAM implant suprastructures
- Patient-specific framework design in collaboration with the dental laboratory
- Perfect, tension-free fit of restoration, even at the first fitting, even for large and complex reconstructions, thanks to the high precision computer-controlled process



1-3 | Occlusally screw-retained Atlantis bridge on six implants and Ankylos Balance Base Abutments narrow (courtesy of Dr. Daniel Grubeanu, Trier, Germany).

4-7 | Examples of CAD/CAM-fabricated Atlantis bars.

## The SmartFix<sup>®</sup> concept

The SmartFix concept is an implant-prosthetic procedure for the immediate restoration of edentulous patients with screw-retained bridges or bar dentures in the maxilla and mandible.

To obtain a common insertion direction, the implants placed in an angle are provided with 15° or 30° angled

Ankylos Balance Base abutments.

The implant prosthetic procedure for the immediate restoration with angled implants in edentulous patients

- provides stable prosthetic fit
- avoids critical anatomical areas by using angled implants

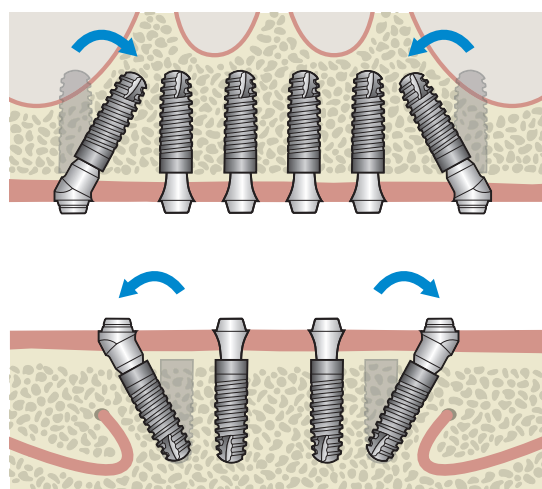
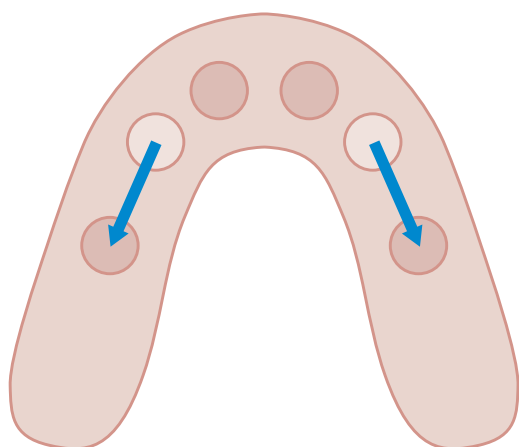

### Stable prosthetic fit

The area supporting the prosthesis is extended distally by the angled implant position and the local bone is thus utilized optimally.

### Avoiding critical anatomical areas

Augmentation and critical anatomical areas can be largely circumvented by using implants placed in an angled position. For example, this avoids the need for sinus floor elevation in the maxilla or nerve transposition in the mandible.

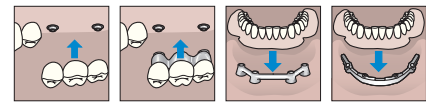

Two procedures of fabrication can be selected for prosthetic restorations: Either the conventional fabrication of a suprastructure or CAD/CAM-fabricated Atlantis suprastructures with a high precision fit.

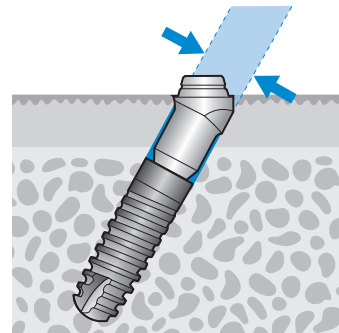
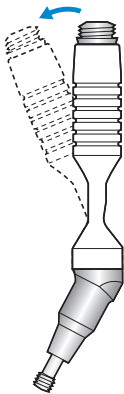

The very small abutment head provides optimum freedom of design for the suprastructure in terms of height and diameter.

Secure handling with facilitated delivery of the abutment by the short and flexible seating instrument, especially when space is restricted.

Free positioning of implant and abutment by non-indexed Ankylos Balance Base abutments.

Sub-crestal placement due to the keyed and friction-locked Ankylos TissueCare taper connection. This largely avoids inflammatory responses in the peri-implant tissue. This benefits the SmartFix concept as the distal implant shoulder is always below the bone level for angled placement.

Pronounced horizontal offset shifts the transition between the implant and the abutment in central direction. This enables easier access of the angled abutment to the implant. Mechanical and microbial stimuli are kept from the peri-implant tissue. Collision with the distal bone crest is largely avoided by the extremely narrow abutments.

Utilization of perfect-fit CAD/CAM-fabricated suprastructures made of titanium or cobalt chrome. Optimal connection of the angled Balance Base abutments to the Atlantis supra-structures.

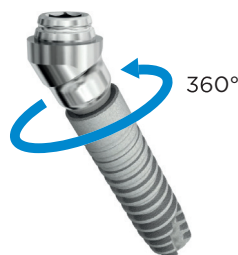

# Prosthetic components for Balance Base Abutment C/

Ankylos Balance Base Abutments are used for the prosthetic restoration of several Ankylos implants with screw-retained bridges or bar constructions. As there is no anti-rotational device between abutment and suprastructure these abutments have to be used at least in pairs.

There are two options available for the fabrication of prosthetic restorations:

- On the implant level with selection of the prosthetic abutments in the laboratory
- On the abutment level with the patient's early incorporation of the abutments

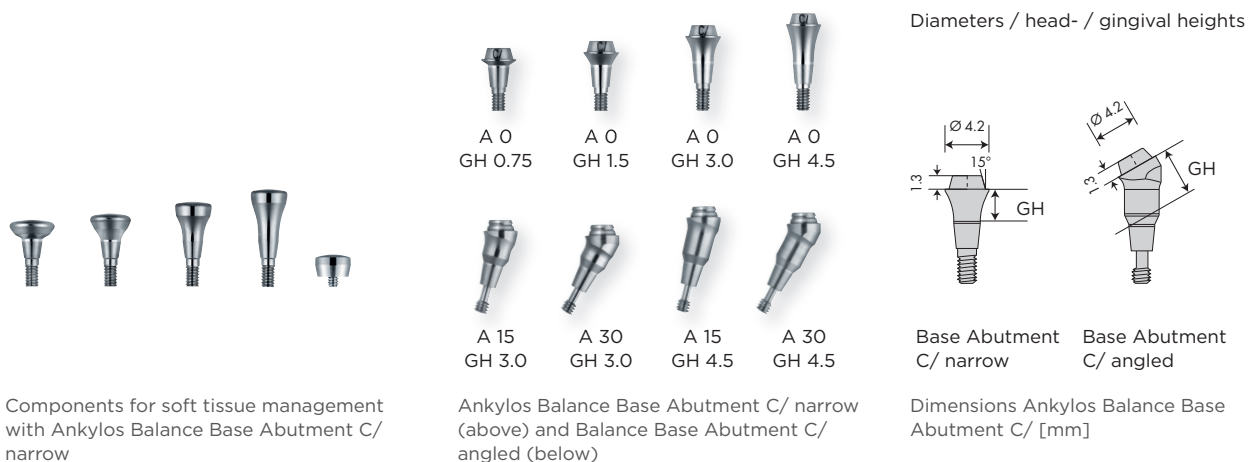

Components for soft tissue management with Ankylos Balance Base Abutment C/ narrow

Ankylos Balance Base Abutment C/ narrow (above) and Balance Base Abutment C/ angled (below)

Dimensions Ankylos Balance Base Abutment C/ [mm]

## Soft tissue management, Balance Base Abutment C/ narrow

### Ankylos C/ Gingiva Former, D 4.2

- For contouring the peri-implant soft tissues for use of the Balance Base Abutment C/ narrow and SynCone 5°
- Selection according to gingival height
- One-piece, with integrated thread

### Ankylos Protective Cap for Balance Base Abutment, narrow

- For contouring the peri-implant soft tissues after incorporation of Balance Base Abutments narrow.
- For temporary closure of the basic abutment, narrow, in place during the laboratory phase
- One-piece, with integrated thread

## Prosthetic restoration

- For retaining overdentures using bar construction and screw-retained bridges
- Also for CAD/CAM bars and bridges
- Up to four gingival heights allow adjustment to the clinical situation
- Combination of straight and angled abutments for the SmartFix concept
- Only for occlusal screw retention
- Screw retention with occlusal hex fixation screw M 1.6 mm (order no. 3105 6022, blue anodized)

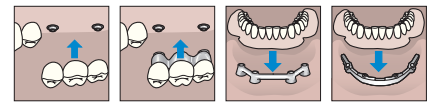

Balance Base Abutments should be used at least in pairs and are not suitable for cemented suprastructures. Single-tooth restorations are contraindicated.



Prefabricated copings for Balance Base Abutment narrow



Ankylos Analog Balance Base Abutment narrow



Ankylos Fixation Screw Occlusal M 1.6 mm Hex short (anodized blue), long (flush with coping), extra long and 19 mm (extends coping by 5 mm)

### Impressions at abutment level

#### Ankylos Retention Coping for Balance Base Abutment narrow and Balance Base Abutment

- For simplified impressions on the abutment level, giving increased precision for CAD/CAM structures
- Incl. M 1.6 mm occlusal hex fixation screw (blue anodized)
- With extra long fixation screw, (order no. 3105 6025); also for transfer of the abutment position using the open tray technique

### Pre-fabricated copings for Ankylos Balance Base Abutment C/

- For simple fabrication of prosthetic restorations without changing abutments in the patient's mouth
- Copings are used both for straight and angled Balance Base abutments

### Occlusal Screw Fixation/ Retaining Screws

- The long occlusal screw flushes with the copings, the extra long occlusal screw exceeds the coping by 5 mm
- For fastening use screwdriver 1.0 mm hex, recommended torque 10 Ncm

# Step-by-step: Abutment insertion

## Balance Base Abutment C/ narrow

## Balance Base Abutment C/ narrow angled

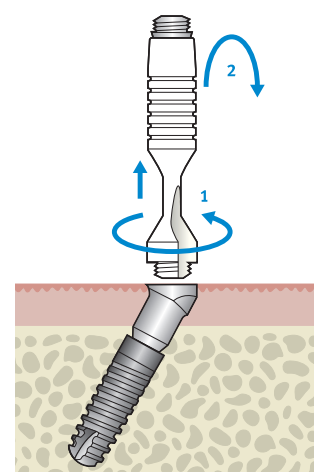
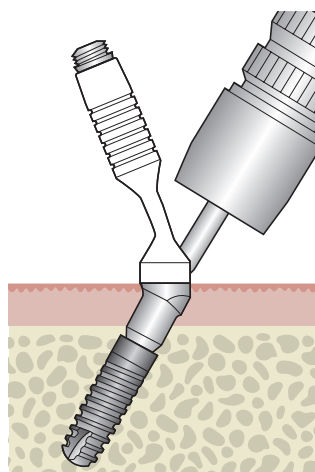
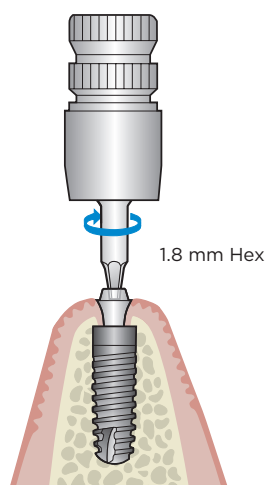

### Insert Ankylos Balance Base Abutment C/

After removing the gingiva-forming components, screw the appropriate Balance Base Abutments C/ selected in accordance with the gingival height and diameter into the implants. Clean the implant connection tapers of any tissue residues beforehand. Screw-retain the abutments using the torque-wrench with the 1.8 mm hex insert and a torque of 25 Ncm.

The Base Abutment must not be inserted using the 1.0 mm hex insert, since this will damage the occlusal thread.

### Screw-retaining of the angled prosthetic abutments

Usually angled Balance Base abutments are mounted right after implant insertion following an immediate loading protocol. The abutment body of the angled Balance Base abutment is positioned in the implant using the seating instrument. The abutment platform should be parallel to the occlusal plane. The insert for the prosthetic ratchet 1.0 mm hex is used for screw retention. The torque required for the straining screw is 15 Ncm. If necessary, post-preparation of the surrounding bone may be required prior to delivery of the abutment. Check the final fit of the abutments via radiographic imaging.

### Unscrew seating instrument and reverse

The seating instrument is unscrewed from the abutment body of the angled Balance Base abutment by rotating to the left. Then rotate the seating instrument through 180° to position the abutment head.



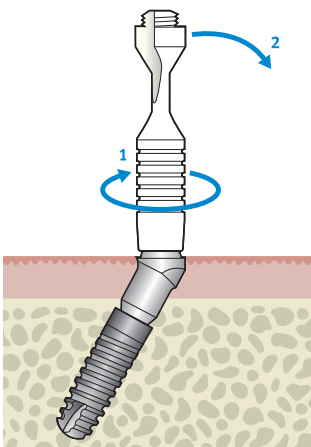
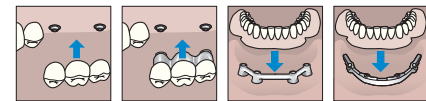

### Insertion of abutment head

Following final screw retention of the abutment body, the abutment head is hand-tightened into the abutment body using the seating instrument.

Then snap off and remove the seating instrument from the abutment.

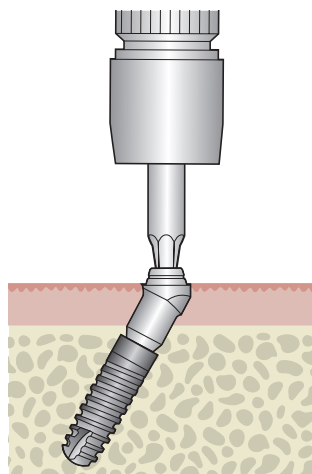

### Screw-tightening of abutment head

Screw the abutment head finally in at 25 Ncm by using the insert for prosthetic ratchet 1.8 mm.

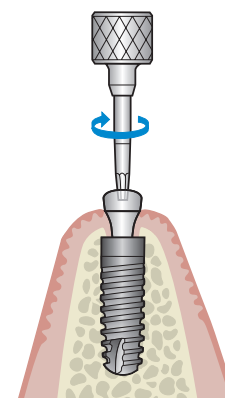

### Option: protective cap for Balance Base abutment

In case the Balance Base abutments remain in the patient's mouth or when following an immediate loading protocol the abutments are sealed with the narrow protective cap for Balance Base abutments until delivery of the prosthetic restoration.

## Step-by-step: Impression on abutment level and temporization

### Balance Base Abutment C/ narrow

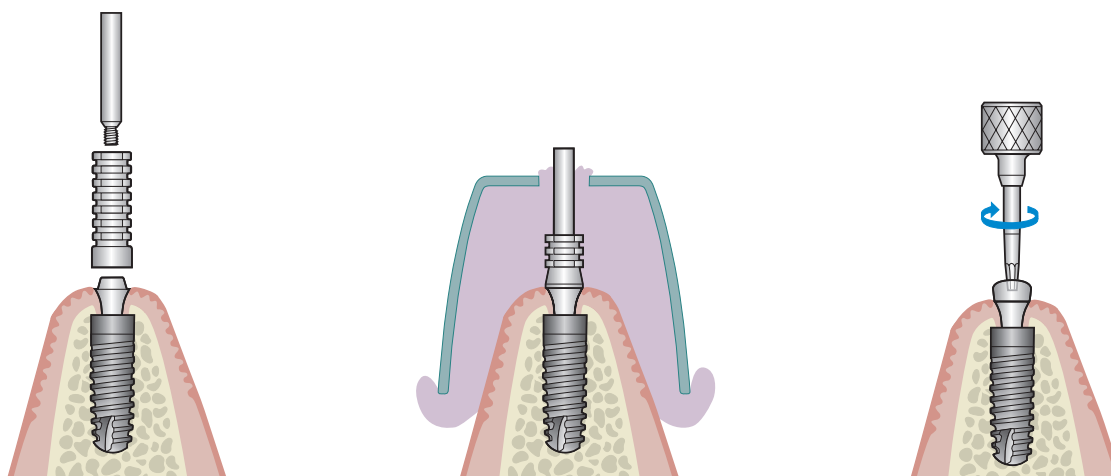

#### PickUp impression via retention coping

Place the retention copings matching the abutments on these abutments and screw-retain with a long screw whereby the following screws are used:

- Balance Base Abutment narrow: occlusal fixation screw, extra long M 1.6 mm (order no. 3105 6025)

The impression is taken with an open tray. After the impression material has set, undo the transfer screws and remove the impression. The retention copings remain in the impression.

The impression including copings and transfer screws is sent to the laboratory for casting the model.

#### Ankylos protective cap for Balance Base Abutment C/ narrow

The Balance Base Abutments C/ narrow remain in the patient's mouth. These are sealed using the protective caps for Balance Base Abutments, narrow, until the prosthetic restoration is delivered.

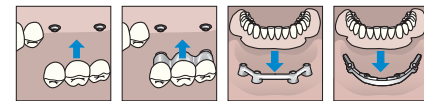

### Notes on using the old prosthesis:

- Hollow-grind the prosthesis adequately
- Avoid imperfections at the retention caps
- Avoid excessive polymerization shrinkage
- Protect soft tissue, i.e. using a cofferdam curved incision
- Mix cold-cure polymer bubble-free and viscous
- Cover retention copings completely

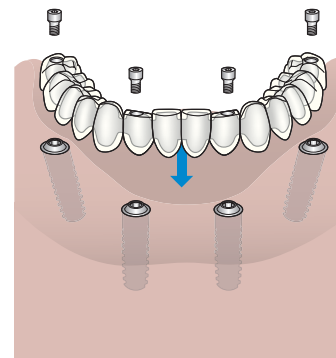
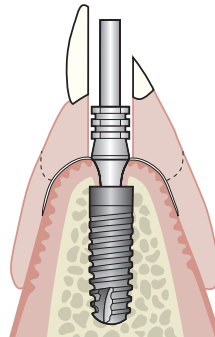
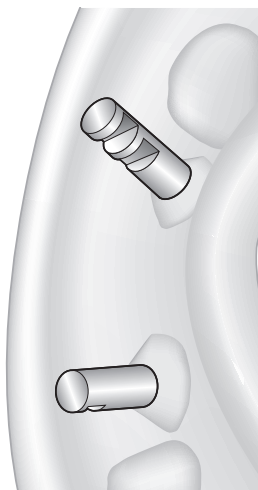

### Model casting

Using the occlusal fixation screw extra long, screw the implant analogs for the Balance Base abutment narrow together with the retention copings fixed in the impression.

Model casting is always performed with straight analogs.

### Long-term temporary denture

The existing prosthesis can be modified to provide temporary restoration. To avoid misalignment of the retention caps in the prosthesis with resulting changes in occlusion, any transverse and/or vertical displacement of the prosthesis must be avoided during the polymerization process. Extended functional margins can be shortened as far as possible.

### Screw-retention of suprastructure

Clean and disinfect suprastructure and screw to Balance Base abutments using the 1.0 mm hex screwdriver and a torque of 10 Ncm (see the following pages for details).

# Step-by-step: Impressions for CAD/CAM restorations

A precise master model which reproduces the clinical situation exactly for the dental laboratory, is crucial for the perfect fit for a CAD/CAM-fabricated Atlantis implant suprastructure, even at the first fitting.

The procedure described in the following includes several treatment sessions and is conducted in close collaboration with the dental laboratory.

## Atlantis implant suprastructures: CAD/CAM-fabricated bridges and bar-supported dentures

Patient-specific Atlantis implant suprastructures for Ankylos are always fabricated on the abutment level and fixed with an occlusal screw. As a rule, the Balance Base Abutments matching the gingival height and diameter are selected in the practice. The dental laboratory is sent the occlusal screws required for delivering the restoration from the Dentsply Sirona Implants manufacturing facility together with the implant suprastructure. The dental laboratory will send the prosthetic screws, that can be ordered at the same time as the implant suprastructure, to the practice with the finished bridge or bar denture.

Atlantis implant suprastructures are available in titanium and cobalt-chrome.

An absolutely precise impression of the clinical situation is crucial for the perfect fit of a CAD/CAM-fabricated implant suprastructure at the first fitting and should be conducted over several consultations. It is important to observe the following instructions.

### Dental practice

### Dental laboratory

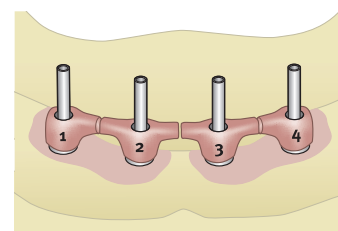
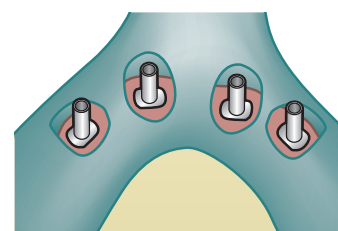
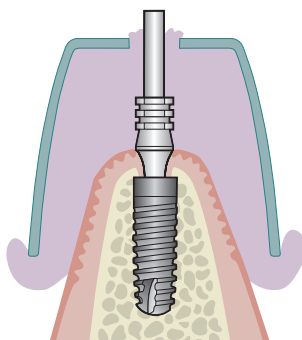

### First consultation: Impression for situation model

After removing the gingiva-forming components and, if given, delivery of the Balance Base Abutments, the first impression is taken by means of the PickUp technique via retention copings (see pages 66/67).

When using Balance Base Abutments C/ narrow, these are then sealed with protective caps until the next session. Otherwise the abutments are replaced again with Ankylos Balance Posterior C/ sulcus formers.

The impression is sent to the laboratory.

### In the dental laboratory: Fabrication of the situation model, individual tray and primary splint

A situation model is made from the impression. Based on this model, a customized tray is manufactured for the PickUp technique. Adequate space for the impression material must be ensured when the tray is manufactured.

The retention copings are used for the fabrication of the primary splinting. The autopolymer splint is divided into individual segments and sent to the practice for making the intraoral splinting and taking the impression.

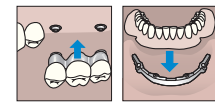

## Dental practice

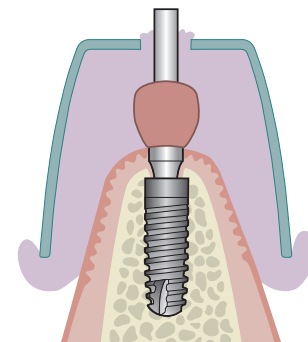
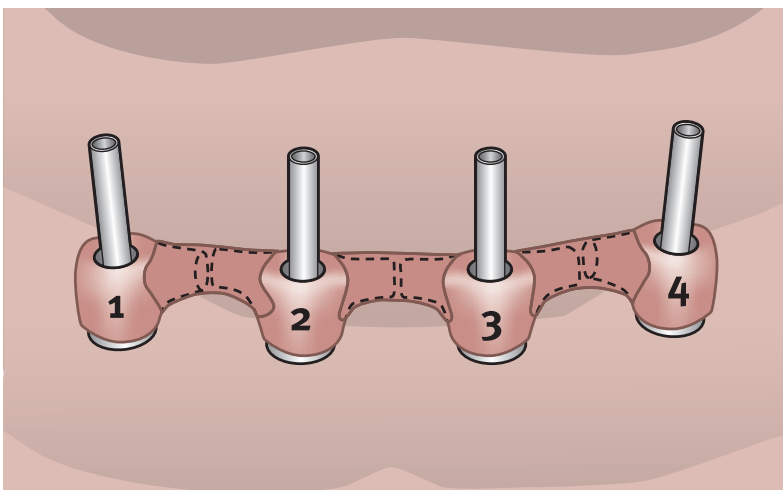

### Second consultation: Intraoral splinting of the synthetic elements

Remove the protective cap and attach the Balance Base Abutments. Attach the individual synthetic segments for the primary splint sent by the laboratory to the Balance Base Abutments using the respective fixation screws. An adequate space between the individual segments should be ensured here. Where there is contact, trim the synthetic material.

Then splint the tension-free synthetic segments intraorally with the same autopolymer used by the laboratory.

### Splint impression

The impression is then taken over the now splinted retention caps using impression material and the customized tray. The fixation screws can be undone and the entire tray removed after the dental impression material has set.

This high-precision impression is sent to the laboratory for fabricating the master cast.

## Step-by-step: Impressions for CAD/CAM restorations

It is only from this second impression that the laboratory will fabricate the master cast and the wax mock-up of the intraorally splinted situation.

### Dental practice

### Dental laboratory

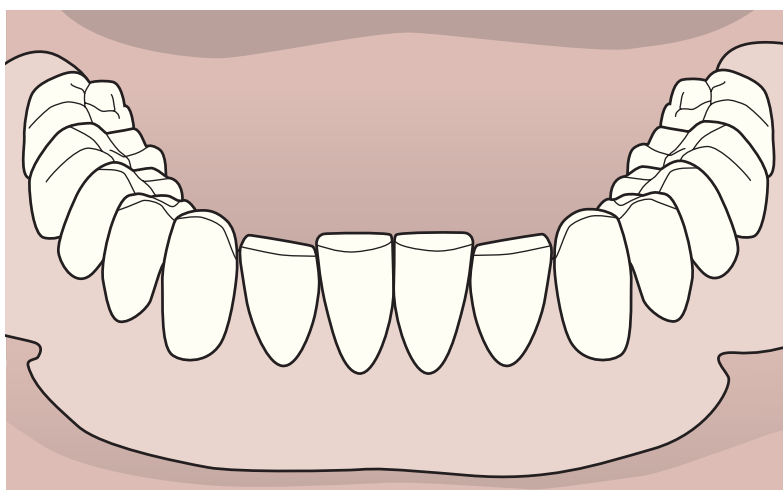
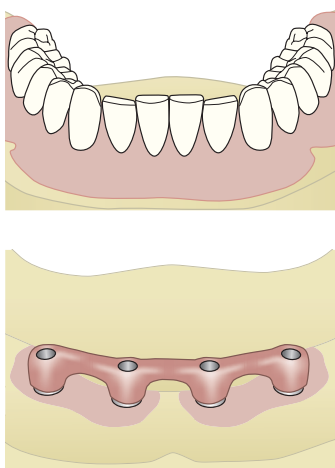

#### **In the dental laboratory: Prepare the wax-up and transfer key**

After completion of the master cast, a wax mock-up with tailored teeth is made on this.

A second transfer key is made from autopolymer, in order to be able to compare the implant position in the master cast with the clinical situation. This key is finally splinted in the laboratory.

Both are sent to the practice for checking intraorally.

#### **Third consultation: Try-in of wax-up**

In third consultation, the wax mock-up with tailored teeth made by the laboratory on the master cast is checked in the patient's mouth in respect of function and esthetics and is corrected if necessary.

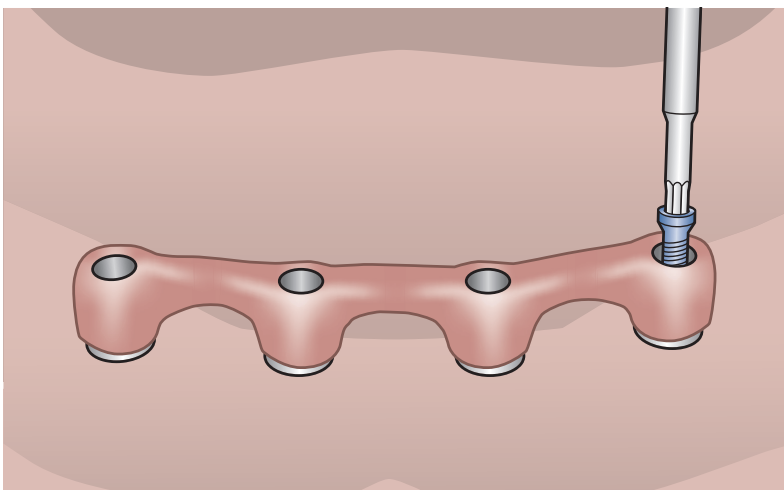
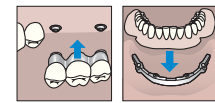

### Sheffield Test

The autopolymer transfer key fabricated by the laboratory for comparison of the implant positions in the master cast with the clinical situation is attached to the implants. The tension-free fit of the transfer key is checked intraorally with fixation screws, which are each separately tightened in sequence (Sheffield Test, see right).

Provided no fitting problems appear or these have been corrected, the dental laboratory will order the Atlantis implant suprastructure via [www.atlantisweborder.com](http://www.atlantisweborder.com) after approval of all components by the practice.

The completed bridge or bar restoration is fitted as usual, as described on pages 72/73.

### Sheffield Test

The Sheffield Test facilitates a simple check of the fit of a primary splinted mesiostructure on implants. After the structure has been positioned, each fixation screw is tightened separately while the other screws are not screwed in. Thus, the structure is only attached to one implant each time.

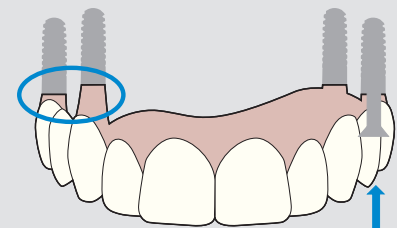

When a screw is tightened, a tension-free framework will remain resting on all of the implants.

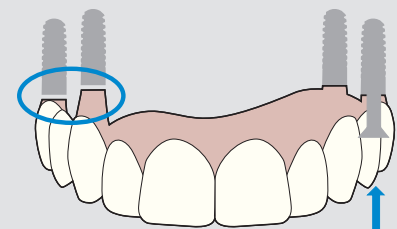

If the structure is not tension-free, a gap will be formed between the implants not screw-retained and the structure or this will change.

# Step-by-step: Delivery of the bridge or bar-supported denture

Ankylos Balance Base Abutments C/ are used to retain overdentures by means of a bar restoration. Another option is to fix bridges onto Base Abutments. The procedure for the delivery of bar-supported dentures or bridges is identical, no matter whether the restoration has been fabricated conventionally or

with a CAD/CAM-fabricated Atlantis implant suprastructure. If the simplified impression option using the retention coping has been selected, the Ankylos Balance Base Abutments C/ are already located in the patient's mouth. In this case, you can begin with inserting the suprastructure right away.

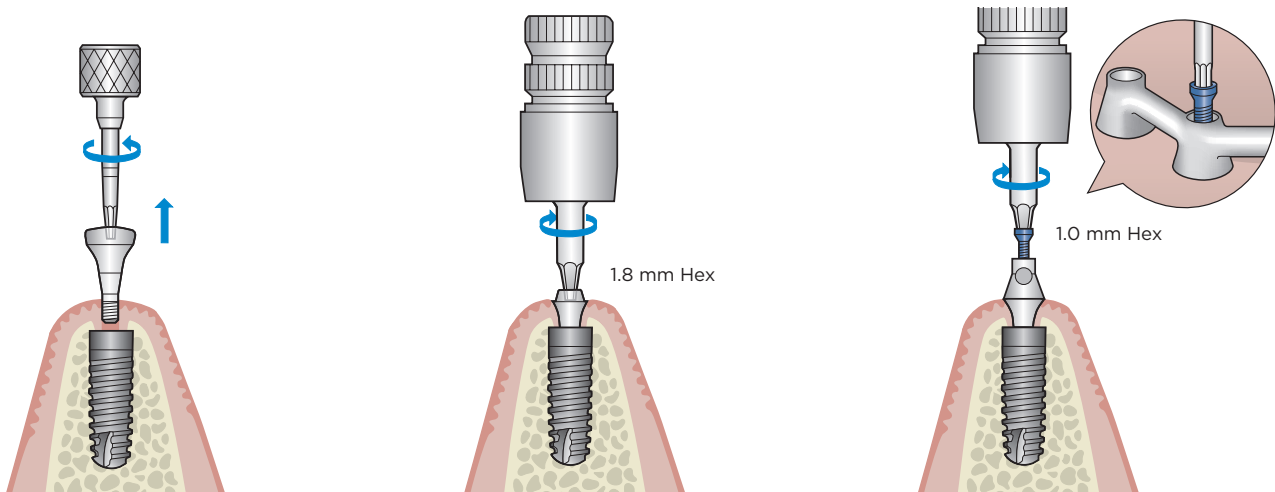

Remove the prosthetic restoration supplied by the laboratory from the model and unscrew the abutments from the implant analogs in the model. Clean and sterilize the abutments.

Unscrew the gingiva-forming components from the implants, clean the connection taper in the implant with air/water spray and dry thoroughly using an air spray.

### Screw in prosthetic abutments

Position the Ankylos Balance Base Abutments C/ in the implants and screw-retain these. The torque wrench with 1.8 mm hex insert is used for the screw-retention. The recommended torque for the Balance Base Abutment C/ is 25 Ncm.

### Insert suprastructure: Bar

Clean and disinfect the suprastructure. Screw-retain the bar framework with the 1.0 mm hex screwdriver and a torque of 10 Ncm on the Ankylos Balance Base Abutments.

The Base Abutment must not be inserted with the 1.0 mm hex insert, as this will damage the occlusal thread.



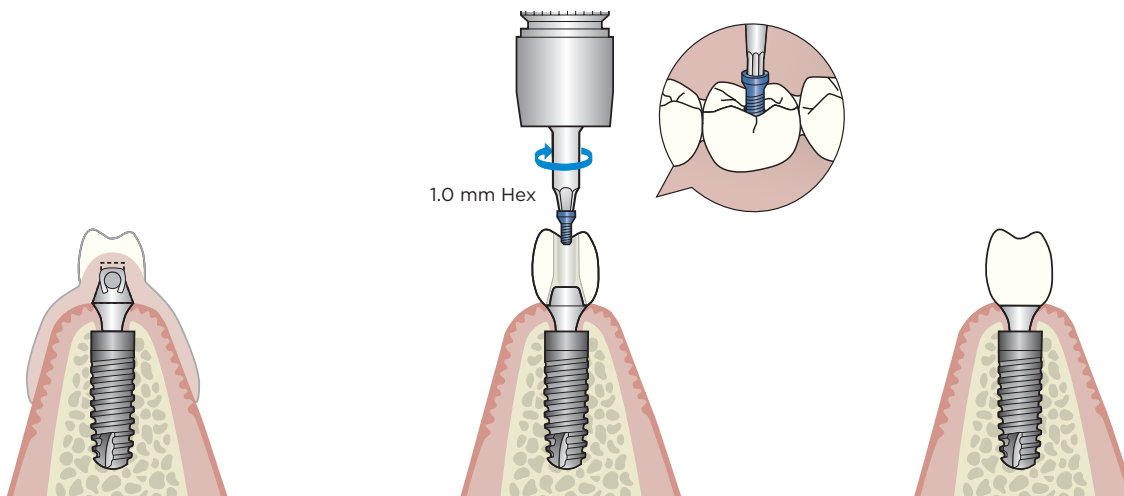

### Insert suprastructure: Bridge

Check the fit of the bar-supported denture and the retention of the bar slides on the inserted framework. Then insert the prosthesis.

Check the fit of the suprastructure on the inserted abutments. Clean and disinfect the suprastructure.

Screw-retain the suprastructure with the occlusal screws sent by the laboratory with a torque of 10 Ncm. Seal the occlusal screw channels with composite.

Cementing is not possible, since the height of the abutment heads does not offer sufficient retention.



# SynCone<sup>®</sup> C/

Ankylos SynCone C/ abutments made of titanium alloy Ti6Al4V provide a fast and economical restoration of the edentulous mandible with an immediately loaded prosthesis on four prefabricated interforaminal tapered abutments.

Minimally invasive treatment allows delivery of the prosthesis even during anesthesia. Within the context of delayed restoration, Ankylos SynCone C/ 5° serves as a prefabricated retaining element for prostheses with four implants in the mandible and six implants in the maxilla.

The prosthesis is fabricated in the laboratory. Intraoral bonding of the components provides the prosthesis with a tension-free fit (passive fit).

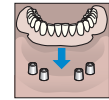

# Overdentures on Ankylos® SynCone® C/

## Ankylos® SynCone® in immediate loading

SynCone is ideal for the requirements of a geriatric immediate loading concept. The patient can leave the dental clinic with a fixed prosthesis in as little as two hours after the start of the treatment. SynCone offers the practitioner key advantages:

- Reduction of the total treatment time
- Simplification with prefabricated components for chairside procedure
- Clinically proven suitability of Ankylos implants for immediate loading with an innovative prefabricated application of the telescopic crown technique

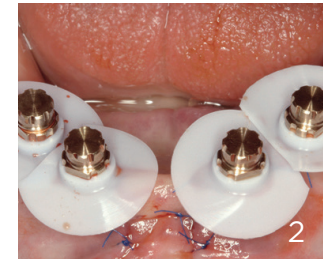
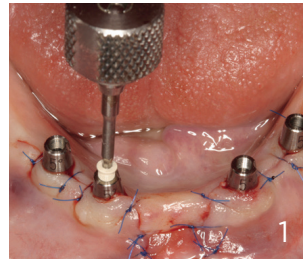

## Ankylos® SynCone® in delayed loading

If immediate loading is not possible or not required, SynCone has several advantages when used on healed implants:

- Tension-free seating (passive fit) with intraoral cementing of the taper cap to the framework
- Simplification with prefabricated components for chairside procedure
- Prosthesis retention is superior to a bar milled by a time-consuming process and also much more economical
- Improved hygiene for patients



1-4 | Immediate restoration of the edentulous mandible with Ankylos SynCone.

5-8 | Laboratory manufactured prosthesis on healed implants (courtesy of Dr. Dittmar May, Lünen/Germany).

# The tapered crown principle

Ankylos SynCone transfers the clinically proven stability of the tapered abutment connection to the abutment-prosthesis connection. This second tapered connection ensures that the final restoration is tightly seated minimizing gaps and micromovement. Compared with bar restorations or other prefabricated connecting components, SynCone tapered crowns offer a stable and friction-locked connection that helps to eliminate problems often associated with edentulous jaws, such as:

- Pain of pressure of ill-fitting dentures
- Atrophy as a result of inactivity or pressure
- Continued bone loss requiring relining of existing denture
- Design-related difficulties with the mesostructure

A connection with a tapered cone design serves as a retaining element where the tapered cap is retained on a tapered abutment by surface contact. When the retention is disconnected, the prosthesis is released, allowing for easy removal. In contrast, a parallel-walled, telescopic design creates a friction throughout the complete path of insertion.

Patients find it easier to insert a prosthesis with tapered connection design, because the bottom diameter of the tapered caps connected to the denture is always larger than the top diameter of the abutments.

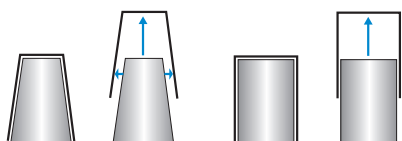

Simplified insertion and removal of the prosthesis with tapered abutments (left) in comparison with parallel-walled retaining elements (right)

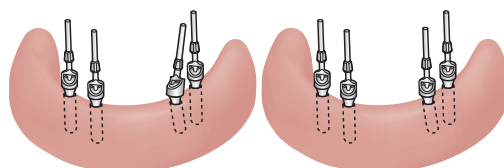

Creation of a common direction of insertion for abutments with non-indexed, tapered connection

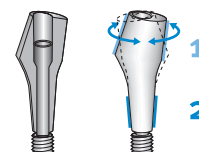

## The synergy of the two tapers

The tapered TissueCare connection allows for free 360° alignment of the non-indexed abutments in any position. This enables aligning angled abutments by rotation until the insertion direction of the prosthesis has been reached (staggered-taper principle).

Ankylos SynCone abutments have an integrated, mobile straining screw so that the taper of the abutment head can be rotated in the connection taper of the implant as needed to form a common direction of insertion.

## Advantages for patients

The tapered crown principle effectively makes the prosthesis into a removable bridge with:

- Very high stability
- High chewing comfort
- Reduced prosthesis base
- Improved phonetics
- Optimum hygiene capability

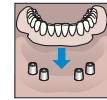

# Prosthetic components Ankylos® SynCone® C/

The abutments for the Ankylos SynCone treatment concept are only available with non-indexed tapered connection geometry, as free positioning of the abutments is essential.

All Ankylos SynCone C/ components are laser-marked with a "C/" as in "C"onus according to their possible use.

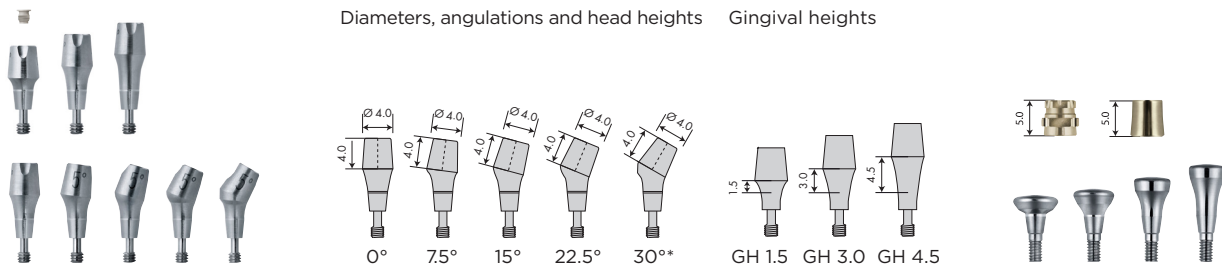

Ankylos SynCone C/ abutment 5°, straight and angled, cover screw for straight abutment

Dimensions Ankylos SynCone C/ abutment [mm]

Tapered caps for Ankylos SynCone (above), Ankylos C/ gingiva former D 4.2 for soft tissue contouring in delayed loading (below)

## Prosthetic restoration

### Ankylos SynCone C/ Abutment

- For the restoration of the edentulous mandible with an immediate or delayed loaded prosthesis on four prefabricated tapered abutments placed interforaminally
- For the restoration of the edentulous maxilla on six osseointegrated implants\*
- Abutments with 5° tapered angle, adaptable to the clinical situation via three gingival heights (1.5/3.0/4.5 mm) and five angulations (0°, 7.5°, 15°, 22.5° and 30°).
- Cover screw for straight 5° abutments must be ordered separately

\* 5° tapered angle only

### Ankylos Tapered Cap Degulor for SynCone

- Caps with retention for secure attachment of an existing prosthesis to SynCone abutments
- Caps without retention for bonding to the metal base of a newly fabricated prosthesis (in delayed restoration, only for 5° abutment)
- Alloy with high gold content Degulor 3406

### Polymerization Sleeve for Ankylos SynCone

- Prevents the polymerizate from entering the peri-implant sulcus region during polymerization of the caps into an existing prosthesis chairside

## Instruments

### Parallelization Gauge for Ankylos SynCone

- For the parallel axial alignment of the SynCone abutments
- Available for all tapered angles
- Connection for positioning key for SynCone 5°



## Step-by-step: Immediate loading with Ankylos® SynCone® C/

The form of therapy in the edentulous mandible described in the following with immediately loaded Ankylos implants requires the interforaminal insertion of four implants with a minimum length of 11 mm (14 mm are optimal) and the use of SynCone abutments with 5° taper.

A prerequisite for the successful application of the Ankylos SynCone concept is a prosthesis with optimal fit and occlusion as well as the parallel axial alignment of the SynCone abutments.

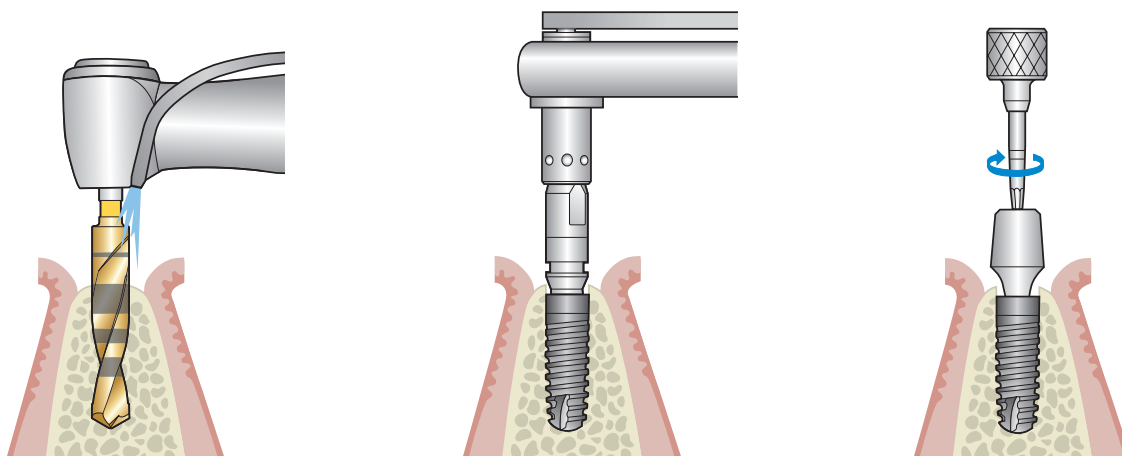

### Implant site preparation

Implant site preparation and implant placement are performed as described in the Ankylos Surgical Manual.

### Implant insertion

The implants are inserted as described in the Surgical Manual and the placement head removed. For better tactile control of the screwing resistance and thus the achieved primary stability we recommend manual bone preparation and insertion of the implant using a torque-controlled ratchet. For planned immediate function, the torque should be at least 35 Ncm to provide sufficient primary stability.

### Screwing in of Ankylos SynCone C/ abutments

The selection of SynCone abutments with 5° tapered angle depends on the thickness of the mucosa. Prior to placing the SynCone C/ abutments ensure that the inner taper of the implants has been rinsed carefully and dried. The SynCone C/ abutments are to be sterilized prior to placement.

The abutments are then screwed into the implants using the 1.0 mm hexagon screwdriver. The torque-wrench with hex insert or a torque-controlled contra-angle handpiece serve this purpose. The recommended torque for the straining screw is 15 Ncm.

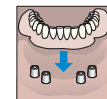

In one prosthesis, only SynCone abutments with the same tapered angle may be used. A prerequisite for the successful application of the SynCone concept is the parallel axial alignment of the SynCone abutments (Fig. above).

If the taper surfaces are parallel due to diverging SynCone abutments, this can cancel taper retention and lead to increased retention (Fig. below).

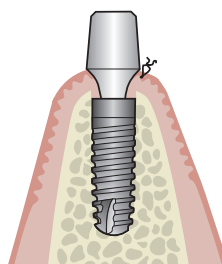
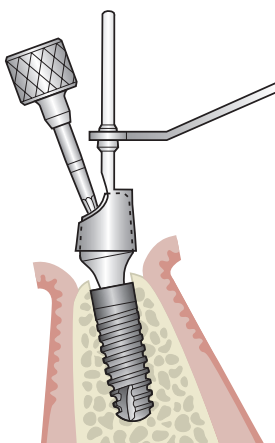
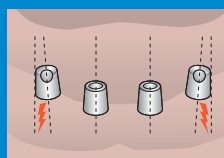
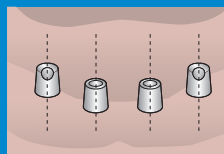

### Aligning the insertion direction of the abutments

For diverging implants, the direction of insertion can be adjusted using angled SynCone abutments.

Using SynCone parallel gauges, the abutments are aligned axially parallel to each other (at least 1° taper over all surfaces).

The positioning key for angled Standard abutments included in the prosthetic tray, which is fixed to the shaft of the gauges, can be used to screw in the abutments via the parallel gauges.

7.5°-angled abutments have to be screwed in first with the 7 mm screw handle, then remove the parallel gauge and tighten straining screw with 15 Ncm.

### Closing the screw channel, wound closure

In the case of straight SynCone abutments with a 5° tapered angle, the hole of the screw channel is to be sealed with the cover screw for the SynCone C/ abutment 5°. For angled abutments this is done with thermoplastics.

Then, close the wound edges saliva-tight by carefully suturing with monofilament suture material. The abutment geometry, with its concave sulcus section, allows tight peri-implant attachment of the mucosa, resulting in elevation of the wound edges in the irritation-protected transmucosal zone of the abutment.

The clinical result after a short period is a well attached, fibrous wound edge.

## Step-by-step: Immediate restoration with Ankylos® SynCone® C/

The prosthesis is to be integrated chairside immediately after insertion of the Ankylos implants and the SynCone abutments. Laboratory-supported incorporation of the caps via impression taking and model casting is not scheduled as part of immediate restoration.

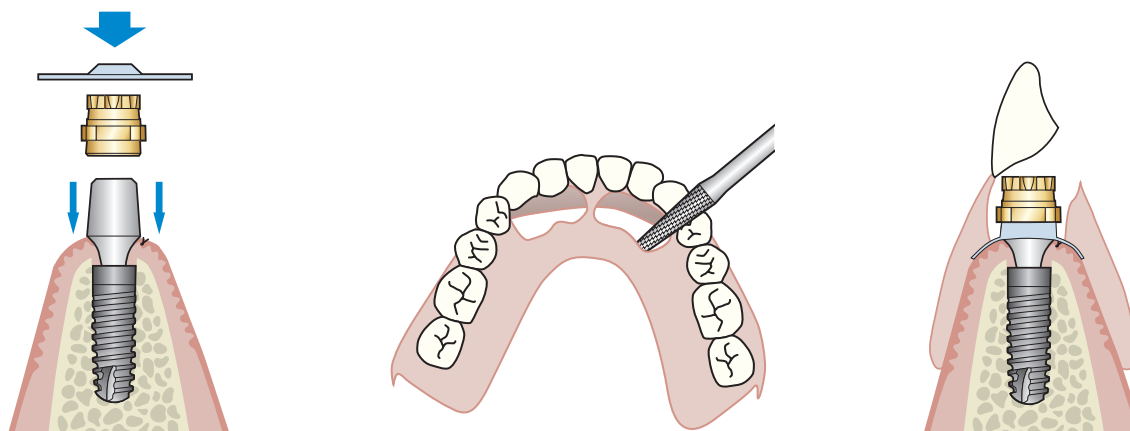

### Attaching Ankylos tapered caps with retention

Sterilize the prefabricated Degular tapered caps with retention for SynCone according to the instructions for use and place them firmly on the SynCone abutments. The retention profile serves for attachment to the plastic base of the prosthesis. Caps without retention may not be incorporated into an existing prosthesis. Then pull the flexible SynCone polymerization sleeve over the cap to below the abutment equator. This prevents any cold-curing polymer from penetrating between cap and abutment or the sulcus region of the abutment and protects the soft tissue. Alternatively, a cofferdam curved incision can be carried out in the same manner.

### Preparing the prosthesis

The prosthesis to be incorporated must match the available mandibular mucosal tegument and meet functional chewing and esthetic requirements. The prosthesis must be ground sufficiently to avoid imperfections on the caps. It also serves as a drilling guide. At the same time grinding should be kept to a bare minimum to avoid excessive polymerization shrinkage.

### Inserting the prosthesis

The caps should be checked for a firm fit on the abutments in their final position prior to inserting the prosthesis. Check that no sutures are trapped when fitting the caps. Then insert the prosthesis. If the prosthesis is too loose, this results from too high pressure on the prosthesis during the polymerization phase. In this case, polymerization needs to be repeated.



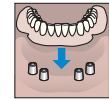

If the prosthesis is too loose, the following errors may have occurred:

- Trapped sutures
- Edges of caps not free of plastic
- Grouting of plastic in the cap
- Extended margins not shortened enough
- Patient moved prosthesis during polymerization

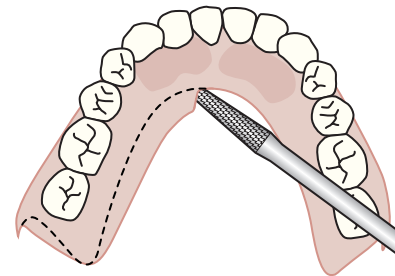
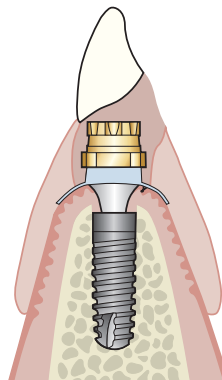
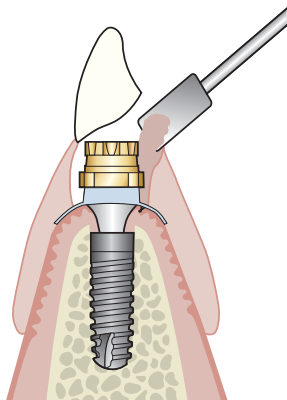

### Polymerization phase

The SynCone caps must be covered bubble-free and entirely with viscous blended cold-cured polymer to ensure stable long-term integration of the caps in the prosthesis body. To avoid misalignment of the caps in the prosthesis with resulting changes in occlusion, any transverse and/or vertical displacement of the prosthesis must be avoided during the polymerization process. A suitable clinical method to accomplish this, is to request the patient “to close his mouth (in habitual occlusion) and to keep the rows of teeth pressed together gently, but properly (in their final occlusion position with tegument contact)”.

Purely manual stabilization often results in occlusal changes. Biting down too hard can lead to a sinking of the prosthesis due to tegument resilience. The elasticity of the thus compressed mucosa and the joined masticatory muscles can inhibit the desired friction between the SynCone abutments and caps, in other words, loosen the prosthesis.

### Finishing the prosthesis and shortening the functional margins

The autopolymerizate must be completely hardened prior to removing the prosthesis. Check for interference-free occlusion and articulation. For finishing and polishing the prosthesis is removed from the oral cavity. Ensure a clearance of 1 mm between the lower edge of the SynCone caps and the synthetic material and that the extended functional margins are trimmed thoroughly.

## Step-by-step: Immediate loading with Ankylos® SynCone® C/

The solution with immediate restoration is to be regarded as a long-term temporary denture. After three to six months, the prosthesis is newly made with a metal reinforcement (see page 84 ff.).

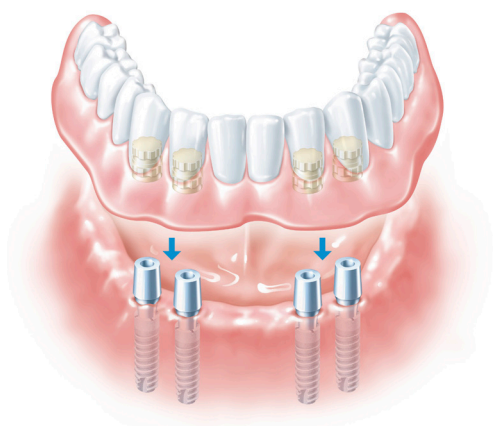

### Inserting the prosthesis

The finished prosthesis is inserted and retention is checked.

The prosthesis must display the required taper retention without functional impairment. Any loosening of the complete denture by the patient moving the muscles of his tongue, floor of the mouth, or cheeks, must not be possible in order to ensure secondary splinting of the implants during the healing time.

Parallel alignment of the interforaminal implants respectively the SynCone abutments as well as primary stability of the implants are the preconditions for a successful application of the SynCone concept. In both, function and resting position, the inserted prosthesis must not allow for any movement.

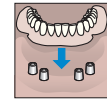

## Postoperative care with immediate loading

Instructions during healing – recommendations to the patient

- Wear the fixed prosthesis permanently for two weeks
- Take a soft diet for 14 days

The patient should use an antibacterial mouth rinse after meals. This serves the prophylaxis of infections as the insertion points of the implants can at first not be cleaned manually.

## Further procedure after healing

The prosthesis is removed from the oral cavity by the dentist after one week when the sutures are removed, and then worn again for one week. Following this two week period, the patient is given detailed instructions on further oral and prosthetic hygiene and on the handling of his mandibular dental prosthesis.

After this period, a normal diet can be resumed. As usual, regular follow-up examinations are necessary to compensate for any deficits on the edges of the prosthesis (no padding).

## Fabrication of the final prosthesis with metal reinforcement

The resin of the prosthesis cannot compensate the forces transferred on the tapered caps on the long term. Therefore, a new, metal-reinforced prosthesis has to be fabricated after three to six months of immediately-loaded healing.

**The procedure for fabrication and delivery of this laboratory-manufactured prosthesis is described on the following pages.**

## Step-by-step: Prosthesis on Ankylos® SynCone® C/ on osseointegrated implants

A metal-reinforced prosthesis is fabricated for the final restoration of the patient.

- As part of the two-stage procedure after submerged implant healing
- As replacement for the long-term temporary denture after healing of the implants placed for immediate loading

After submerged healing and implant uncover, the impression is taken using the components of the Ankylos Balance prosthetic range as described below.

### 1st treatment session: Impression taking

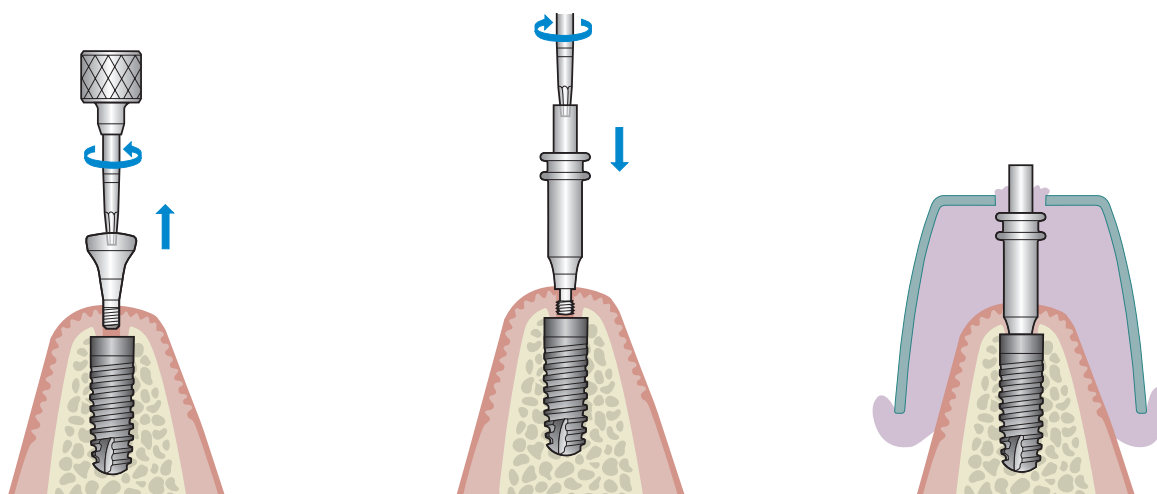

#### Implant uncover and healing of the soft tissue

Uncover of the implants and removal of the Ankylos C/X cover screws are performed as described on page 31. Ankylos C/ gingiva formers D 4.2 are used for contouring the soft tissue. These are hand-tightened with the 1.0 mm hex screwdriver and remain in situ for approximately 14 days. Sterilize the gingiva formers prior to use. The gingiva formers are removed for impression taking and the connection taper cleaned of any residual tissue.

#### Impression Pickup technique (open tray)

The impression is taken using the components of the Ankylos Balance range and an open tray. Clean the connection taper of the implants of any residual tissue. Insert the transfer posts into the connection taper of the implants and attach with transfer screws of the desired length. Hand-tighten the transfer screws. The internal hex is only used here to loosen the screw. Ensure the fit of the transfer posts in the connection taper of the implants. If necessary, the transfer screws can be shortened and provided with a slot.

After the impression material has set, undo the transfer screws and remove the impression with the abutment.

The impression with the transfer screws is sent to the laboratory for casting the model with implant analogs.

The gingiva formers are reinserted until the SynCone abutments are incorporated at the next consultation.

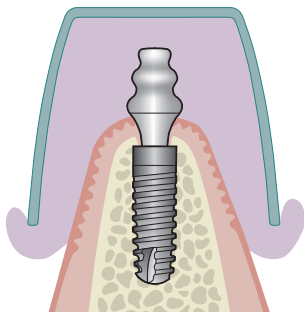
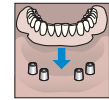

### Alternative: Repositioning technique (closed tray)

If the implants intended for impression do not display any appreciable axial discrepancies, the transfer post can also be inserted using the repositioning technique as an alternative.

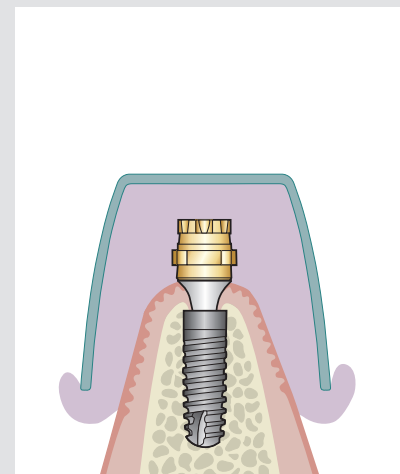
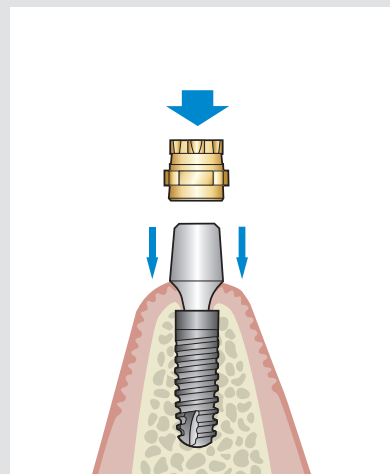

### Simplified impression after immediate loading

First, the SynCone abutments are measured with a parallelometer using a plaster cast fabricated with an alginate impression. Here it should be ensured that the SynCone abutments do not display any parallel surfaces, especially divergences. If this is the case, impressions of the implants should be remade on the healed implants according to the protocol (page 84). The position of the SynCone abutments is transferred to the dental laboratory by means of the tapered caps for SynCone. For impression purposes, the caps are to be positioned loosely

on the abutment. These caps are later integrated into the new prosthesis. The impression is taken with a closed tray using silicone. After the impression material has set, remove the impression and, if necessary, reposition the SynCone caps. The impression with the caps is sent to the dental laboratory for model casting. During the laboratory phase, the patient continues to wear the remodeled immediate loading prosthesis. After fabrication of the final prosthesis the patient can also use this as a replacement.

# Step-by-step: Prosthesis on Ankylos® SynCone® C/ on osseointegrated implants

## Intraoral bonding

To provide a tension-free fit of the prosthesis (passive fit), the prosthetic framework fabricated by the dental laboratory is bonded intraorally to the SynCone caps. As part of this two-stage procedure, the Ankylos SynCone abutments are inserted first in the patient's mouth. This first procedure is omitted following

immediate restoration, as the patient already wears a prosthesis fixed on SynCone abutments. Bonding of the components directly in the patient's mouth ensures maximum precision and thus the fit necessary for the prosthesis when using the taper technique. Bonding by the dental laboratory will lead to failure.

## 2nd treatment session: Intraoral bonding

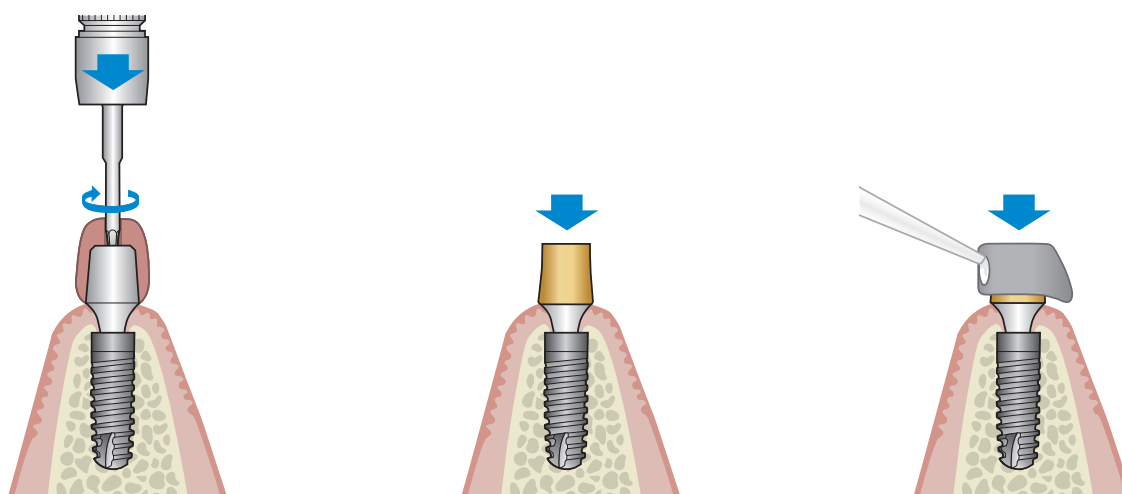

### Screwing in of Ankylos SynCone C/ abutments

Ensure that the inner taper of the implant has been thoroughly rinsed and dried prior to incorporating the SynCone C/ abutments selected in the dental laboratory. The SynCone C/ abutments should be sterilized prior to placement.

The abutments are then screwed into the implants with the 1.0 mm hexagon screwdriver with the aid of the transfer key prepared in the dental laboratory. The torque-wrench with hex insert or a torque-controlled contra-angle handpiece serve this purpose. The recommended torque for the straining screw is 15 Ncm.

### Preparing SynCone caps for bonding

Place the caps on the abutments applying firm pressure. The outer surfaces of the caps were roughened in the dental laboratory by abrasive blasting with aluminum oxide in preparation for bonding, and are cleaned again with alcohol immediately prior to bonding.

### Preparing the framework for bonding

The framework is to be checked for a movement- and tension-free fit as well as for clearance from the basal mucosa. The framework in the cap area should be shorter than the cap margins.

### Bonding framework to caps

Coat the framework with metal adhesive for intraoral use, press onto the caps as for cementing a bridge and allow the adhesive to cure.

Remove excess adhesive prior to hardening, particularly in the undercut areas. Remove the framework with the caps and remove any excess adhesive. After bonding, the framework must not rock and should fit tension-free (passive fit). The procedure should be repeated if this is not the case.

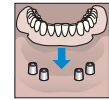

### 3rd treatment session: Delivery

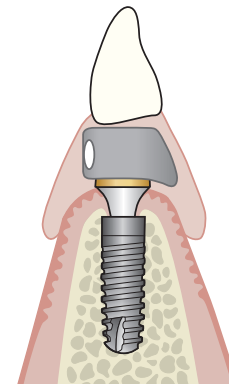
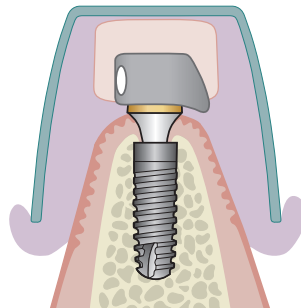
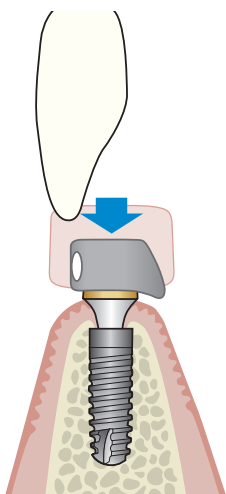

#### Bite registration

The framework is fitted with a synthetic wall after bonding and the bite registration is taken.

#### Overall impression for fabricating the prosthesis

Following bite registration, an unpressurized impression is taken by coating the framework. It is imperative that a plastic tray is used for this process. The impression is sent to the dental laboratory where the metal reinforced prosthesis is then completed.

If an existing prosthesis is worn as a temporary denture during this period, this should be ground out, if necessary, in the region of the abutments now remaining in the patient's mouth and adjusted to the changed situation with non-hardening lining material (not in the case of preceding immediate loading).

#### Delivery of the prosthesis

The prosthesis is delivered according to the principles of full dentures. Any premature contacts should be corrected. The margins of the prosthesis can be shortened as much as possible; maxillary prostheses can be designed without palates.

The patient should be instructed on how to remove and reinsert the denture, and which hygiene measures are to be observed.

# Snap Attachment C/

## Overdentures on Ankylos<sup>®</sup> Snap Attachments C/

Ankylos Snap Attachments C/ are used to attach overdentures in the edentulous mandible simply and economically.

An existing prosthesis can be directly attached at the chairside or an overdenture is fabricated in the laboratory.

Ankylos Snap Attachments are available with tapered implant connection geometry only.



Mandibular prosthesis on two Ankylos Snap Attachments C/



Ankylos Standard C/ sulcus former, compact, for soft tissue contouring (left), Ankylos Snap Attachment C/ with matrix (right)

### Prosthetic components for Ankylos Snap Attachment C/

Ankylos Snap Attachments are laser marked according to their use with the "C/" for "Cone" marking.

Snap attachments allow for compensation of divergences up to 20°.

### Prosthetic restoration

#### Ankylos Snap Attachment C/ complete

- For attachment of overdentures on two implants in the edentulous mandible
- Restoration is fabricated at the chairside or in the laboratory
- Available in three gingival heights
- Two-piece, consisting of snap attachment for screw retention in the implant and matrix for attachment in the prosthesis



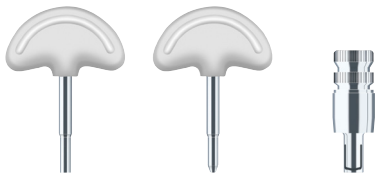
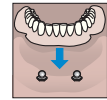

Activator and deactivator for Ankylos Snap Attachment C/, ratchet insert for snap attachment

## Instruments

Along with the instruments contained in the Ankylos Prosthetic Tray, the ratchet insert for snap attachment, 25 Ncm, is required for prosthetic restorations on Ankylos Snap Attachments C/.

### **Activator/Deactivator**

- For adjusting the prosthesis seat for prostheses mounted on snap attachments
- Increases or reduces the friction of the Ankylos Snap Attachment C/ matrix.

## Step-by-step: Chairside processing Snap Attachment C/

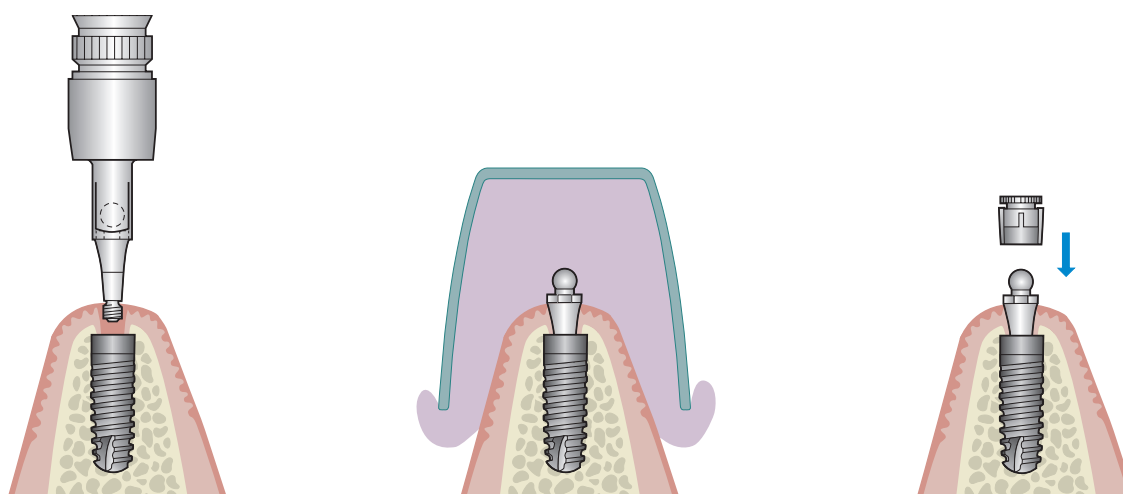

### Inserting the Ankylos Snap Attachment /C

Pick up the abutment with the snap attachment selected according to the gingival height using the prosthetic ratchet and the torque insert for the snap attachment. The abutment is held in the wrench by a spring shackle. Screw the abutment into the implant with a torque of 25 Ncm.

If a new prosthesis is to be manufactured in the laboratory, an impression is taken of the clinical situation after insertion of the snap attachments.

If an existing prosthesis is to be adjusted chairside, the female is polymerized directly into the prosthesis.

### Impression of snap attachment for a new denture

As ball and hexagon of the abutment provide sufficient undercut and positioning aid, the position of the snap attachments is transferred without using a transfer cap. Stable silicone or polyether should be used for taking the impression.

The impression is sent to the laboratory.

### Fitting the snap attachment matrix

The matrices for the snap attachments can be secured directly in the prosthesis in the mouth with cold-cure resin. To do this, position the matrix on the abutment. The attached silicone ring grips the hex of the snap attachment abutment at its bottom end and envelops the lamellae of the matrix at its top end. Hence, the silicone ring retains the matrix in axial alignment with the abutment, prevents cold-curing polymer from penetrating in the undercut region and acts as a spacer for the activator. The matrices should be aligned parallel to one another in order to prevent premature wear.

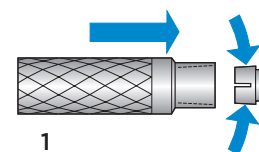
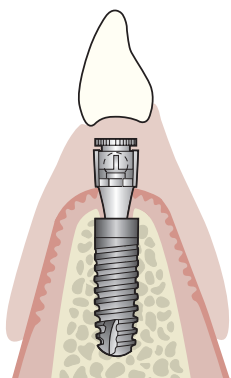
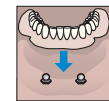

1

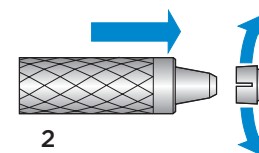

2

### Direct processing of the snap attachment matrix

The snap attachments are secured in the prosthesis using cold curing polymer. For doing so, the prosthesis should be ground in the region of the attachment heads such that the matrix does not come into contact with the abutment. The prosthesis is then filled with synthetic material, inserted and attached until the polymer. In this procedure, please observe the manufacturer's directions for the polymer. Then, remove the prosthesis, detach the silicone ring and smooth off any sharp edges. The matrix friction, and hence the grip of the prosthesis, can be adjusted if necessary.

In cases of a new denture where the lab has incorporated the matrix, clean and disinfect the prosthesis supplied by the laboratory. Then attach it onto the snap attachments.

Only the activator or deactivator should be used to adjust the friction. Never bend the matrix lamellae individually with a blade or similar. The resulting uneven strain will cause matrix breakage.

### Adjusting the retention

Should the prosthesis be seated too firmly or too loosely on the snap attachments, the friction of the matrix lamellae can be adjusted using the activator or deactivator.

**Activate (1):** The inner cone of the instrument grips around the lamellae, compresses these and hence ensures an increased friction. The prosthesis fits more firmly.

**Deactivate (2):** The conical side of the instrument pushes the lamellae apart and hence ensures a decreased friction. The prosthesis fits less firmly.



# Locator C/

The availability of simple and secure fixation of an implant-supported prostheses is a significant success factor for restorations in elderly patients.

The Ankylos Locator makes correct placement of overdentures in the maxilla and mandible much simpler, even for patients with restricted mobility, with restricted occlusal volume or in cases with divergent implants.

## **Secure prosthesis retention – enduring durability of the prosthesis**

- Double retention of the Locator abutment in comparison with conventional attachments for a significantly improved seating of the prosthesis
- Optimum prosthesis durability and significantly less wear with the replacement males that can rotate in the metal cap

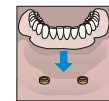

# Overdentures on Ankylos® Locator C/

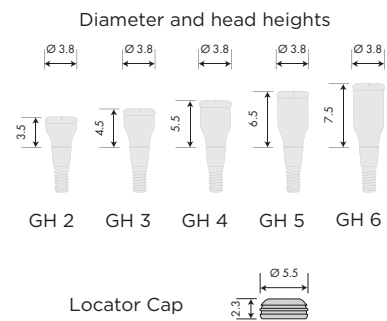
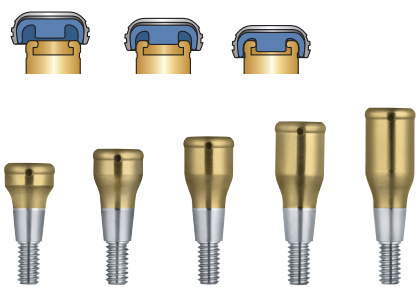

Ankylos Locator Abutments and Locator Replacement Males (clear/strong, pink/light, blue/extra light. Extended range: gray/zero, green/strong, orange/light, red/extra light).

## Self-aligning design - fixation with one click

- Easy alignment of the prosthesis with elastic replacement males of nylon
- Clicks into the exact position by light pressure on the prosthesis

## Low overall height - room to move even in restricted spaces

- Low profile retention area of Locator Abutment
- Sufficient space for easy insertion of the prosthesis even with restricted interocclusal clearance

## Flexible retention - compensation for divergence

- Customized definition of prosthesis retention by color-coded replacement males with variable retention forces
- Axial divergences up to 40° between two implants can be compensated with these inserts

## Step-by-step: Chairside processing Locator C/

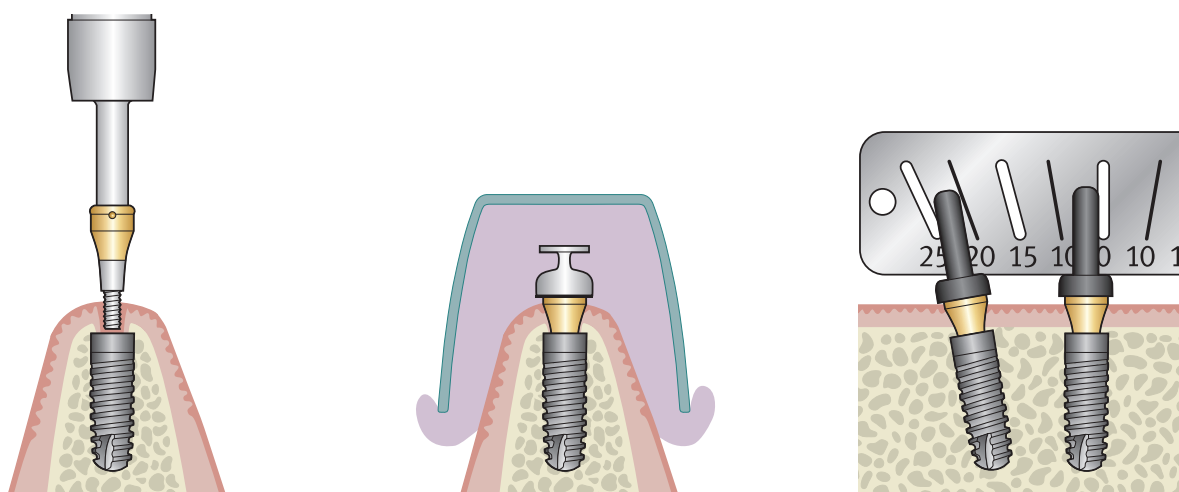

### Delivery of Locator abutments

After removal of the gingiva former, select the Locator abutments to match the gingival height. Screw in the abutments with the Locator insert for prosthetic ratchet or the Locator driver (gold-colored end of the three-piece Locator core tool). For secure handling please slide the abutment holder sleeve on the Locator driver. The Locator abutment will snap into the holder sleeve and will be retained in place. Tighten the Locator abutments to 30 Ncm with the insert and the prosthetic ratchet. If a new prosthesis is to be manufactured in the laboratory, an impression is taken of the clinical situation after delivery of the Locator abutments. If an existing prosthesis is to be adjusted chairside, the female is cemented directly into the prosthesis.

### Impression on Locator level for a new denture

Position the Locator impression copings with integrated black replacement male on the Locator abutments and make an impression of the complete jaw.

The impression is then given to the laboratory. Please make sure that the black replacement males remain in the impression copings.

### Chairside mounting of Locator abutments

Measuring the divergence. Position the black parallel posts on the abutments and measure the degree of divergence with the Locator angle measurement guide.

If the divergences are not greater than 10° per implant, the clear, pink or blue replacement male is used depending on the amount of retention required.

If the divergences are up to 20° per implant use the replacement male in green, orange, red or grey.

In case a divergence exceeds 20° per implant plan for a different retention concept.

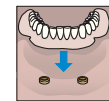

**All treatment steps are conducted with the three-piece Locator Core Tool**

Delivering Locator abutments manually    Insertion of replacement males    Removal of replacement males

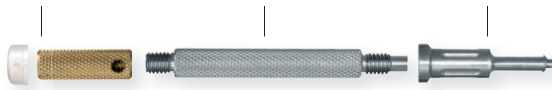

Note: Use the specified torque insert for final placement of the Locator abutment in the implant.

**Ankylos Insert for Prosthetic Ratchet for Locator**



Note: Tighten abutments with a torque of 30 Ncm.

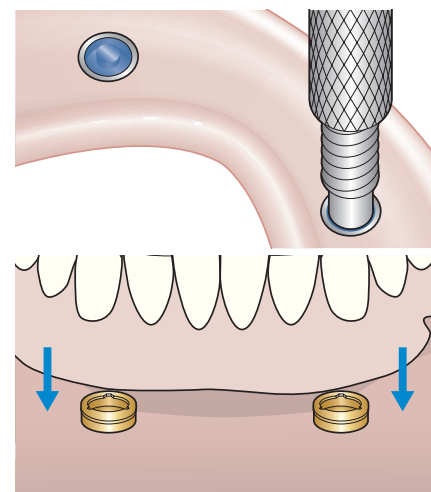
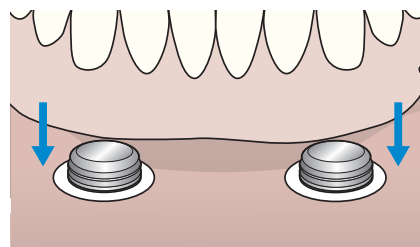
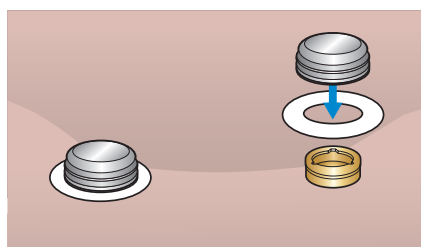

**Placement of females and preparation of the prosthesis**

Position white block-out spacers on the heads of the Locator abutments. Position females with integrated black processing insert (part of the male processing package) on the Locator abutments.

If necessary add additional block-out spacers until no gap is visible between the female, block-out spacer and gum. Grind the prosthesis in the region of the subsequent females.

**Polimerize the females**

Coat the prosthesis with polymer or coldcured polymer, position it and fix it until the polymer is cured.\*

Then remove the prosthesis, remove the black processing replacement males from the females and smooth sharp edges.

\* Please follow the directions of the polymer manufacturer.

**Delivery of prosthesis**

In case a new denture is supplied by the laboratory remove the black processing replacement males from the females of the prosthesis. In case a new denture is supplied by the laboratory remove the black processing replacement males as well.

Press the colored replacement males selected for the divergence and desired retention force firmly into the females with the specified part of the Locator tool. The replacement male must be flush with the margin of the female. Check the retention of the denture with the patient and insert the prosthesis.



# Standard C/

The Ankylos Standard C/ prosthetics range is an option for straightforward and economical reconstruction of edentulous gaps, free ends and edentulous jaws with single crowns, bridges and bar-supported prostheses.

Ankylos Standard C/ prosthetic abutments made from titanium alloy Ti6Al4V are only available with the tapered connection geometry without indexing.



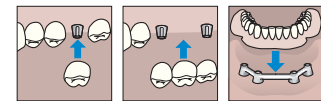

# Crowns, bridges and bar-supported overdentures on Ankylos<sup>®</sup> Standard C/

Ankylos Standard C/ prosthetic abutments are selected and incorporated right after contouring the gingiva, directly at the chairside. After this, the abutments remain in the patient's mouth.

## Ankylos Standard C/ abutment

- Not changing abutment components means simplified handling and optimal patient comfort
- The impression of the abutment location for the laboratory is taken via a cap
- Straightforward provision of a temporary denture for the patient

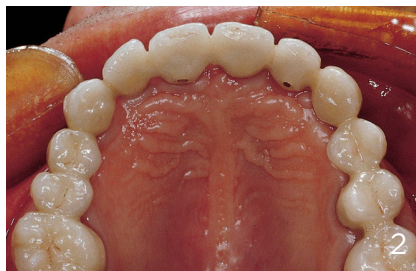

1-2 | Large edentulous gap  
(courtesy of Dr. Terestri, Nizza/France).

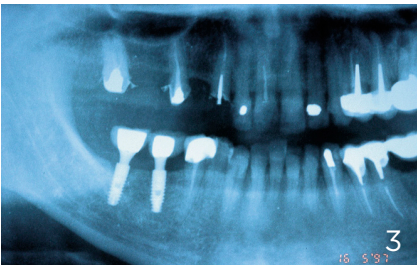

3-5 | Free-end case  
(courtesy of Dr. Parodi, Turin/Italy).



# Prosthetics components Ankylos® Standard C/

All Ankylos Standard C/ components are laser marked according to their use with the “C/” for “Cone” marking.



Ankylos Standard C/  
sulcus former, compact



Ankylos Standard C/ abutments, straight,  
diameter a (above) and b (below)



Ankylos Standard C/ abutments, angled,  
diameter a (above) and b (below)

## Uncovery and soft tissue management

### Ankylos Standard C/ Sulcus Former, compact

- For straightforward contouring of the peri-implant soft tissues
- Selected in accordance with the gingival height and the diameter of the proposed abutment, a or b
- One-piece with integrated thread

## Incorporation of the prosthetic abutments

### Ankylos Standard C/ Abutments, straight

- Two diameters (a, 3.3 mm, and b, 4.5 mm), four gingival heights (1.5, 3.0, 4.5 and 6.0 mm) and two abutment heights (4.0 and 6.0 mm) allow great flexibility
- One-piece with integrated thread
- Chairside abutment selection; the abutments remain in the patient's mouth
- Simplified supragingival impression taking and framework try-in
- Cemented or occlusally screw-retained
- Titanium alloy, Ti6Al4V

### Ankylos Standard C/ Abutments, angled

- Angulation 15°; two diameters (a, 3.3 mm, and b, 4.5 mm), two gingival heights (1.5 and 3.0 mm) and two abutment heights (4.0 and 6.0 mm) allow great flexibility
- One-piece with integrated straining screw
- Cemented or laterally screw-retained
- Titanium alloy, Ti6Al4V

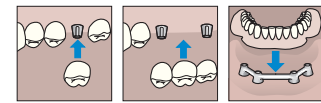

## Instruments

The Ankylos Prosthetic Tray Standard Abutment System contains all the instruments needed for prosthetic restorations on Ankylos Standard C/abutments.

### Head diameter

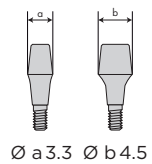

### Angulations and head heights

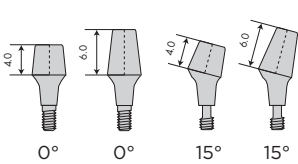

### Gingival heights

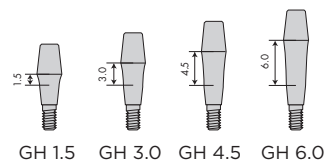

Dimensions Ankylos Standard C/ abutment [mm]

Ankylos Standard transfer caps (above), Ankylos Standard temporary caps (below)

## Impression

### Ankylos Standard Transfer Cap

- For transferring the position of the prosthetic abutment to the master cast
- Attachment to the abutment by retention, also on straight abutments using the wax-up screw, long, order no. 3104 5213 (impression with open tray)
- Color coding according to the abutment diameter and height

## Temporary restoration

### Ankylos Standard Temporary Cap

- For straightforward and quick fabrication of temporary dentures on straight and angled Standard abutments
- Fabrication directly at the chairside or in the laboratory

# Step-by-step: Uncovery and soft tissue management

Where there is submerged implant healing, as a rule, the minimally invasive uncovery of the implants is performed after three to four months and, following this, the contouring of the soft tissue, as described below.

The following steps are not required with transgingival implant healing or not required with immediate restoration using a short-term provisional. The abutments are selected and incorporated immediately.

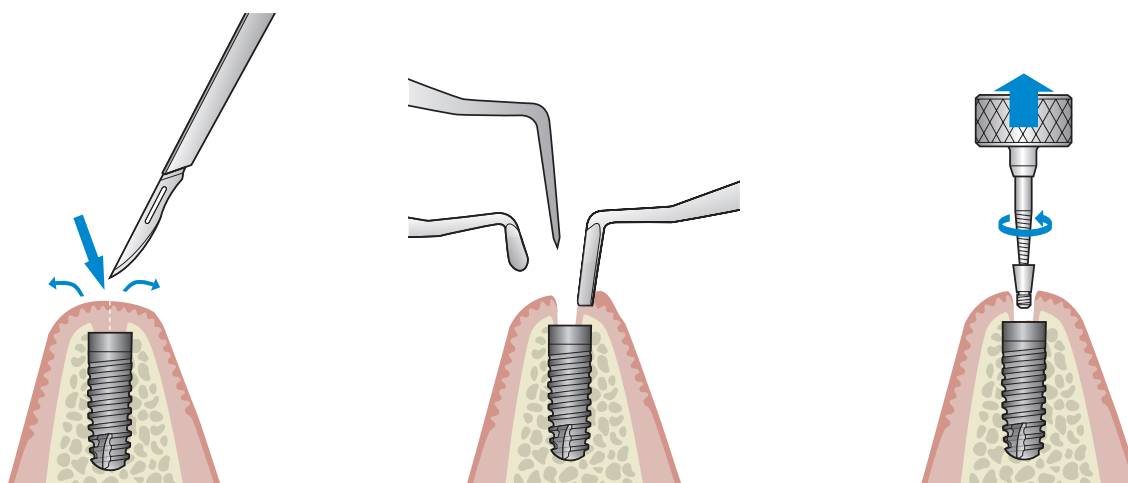

## Incision

After locating the implant and selective anesthesia directly above the implant (e.g. intraligamentous system), a small crestal incision will reveal the implant surface.

Locating the implants may be facilitated by again using the drill guide.

## Implant uncovery

The wound edges are then spread slightly, without exposing the entire surface of the implant, using an angled raspator. Locate the central thread of the cover screw using the probe. Remove connective tissue or bone above the cover screw with the sharp curette, if this is necessary for the rest of the procedure.

## Removing the Ankylos C/X cover screw

Insert the cover screw unscrew instrument into the large 12 mm diameter screwdriver handle and, by gently turning in a counterclockwise direction, screw this into the internal thread of the cover screw. This allows the unscrew instrument to grip the internal thread of the cover screw and to unscrew it. This prepares the implant for fitting the gingiva-forming components.

To remove the cover screw from the unscrew instrument, clamp the cover screw in the rear of a pair of tweezers or hold with a pair of forceps. The unscrew instrument is then turned in a clockwise direction until it disengages from the cover screw.

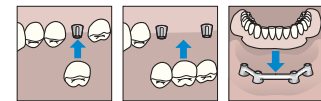

## Step-by-step: Incorporating the abutments

Prosthetic abutments from the Ankylos Standard prosthetics range are selected and incorporated right after contouring the gingiva, directly at the chairside. The abutments are rotation-locked in the implant by the exact fit of the taper.

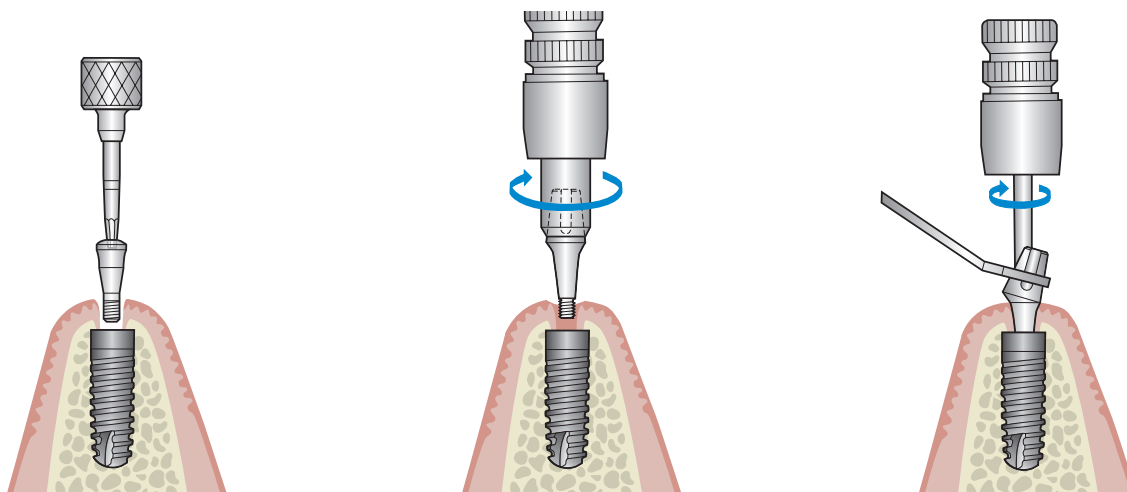

### Ankylos Standard C/ sulcus former, compact

The required sulcus former is inserted using the 1.0 mm hex screwdriver insert in the handle and hand-tightened into the internal implant thread. Sterilize the sulcus former prior to use (see Instructions for sterilization and instrument care).

After a healing phase of approx. 10 to 14 days, the sulcus former can be removed for incorporation of the prosthetic abutments. After removal, the implant connection taper is cleaned with air-water spray and dried thoroughly with an air spray.

### Insert Ankylos Standard C/ abutment, straight

The prosthetic abutment is selected according to the soft tissue conditions. Pick up the straight abutment with the 1.0 mm hex torque insert and the prosthetic ratchet and tighten firmly into the implant. Once the torque is reached, the torque insert disengages and will no longer turn. The recommended torque is 25 Ncm.

### Insert Ankylos Standard C/ abutment, angled

The angled abutment is positioned in the implant and held in the desired orientation with the positioning key. Then the central straining screw is tightened with the 1.0 mm hex torque insert and the prosthetic ratchet. Once the torque is reached, the torque insert disengages and will no longer turn. The recommended torque is 15 Ncm.

For screw-retained suprastructures, the occlusal thread should be sealed using a headless screw (order no. 3105 6010) until delivery of the restoration.

## Step-by-step: Impression and temporary restoration

Synthetic caps are available in the Ankylos Standard prosthetics range for the impression. These are simply placed over the abutments. After the impression is taken, the abutments remain in the patient's mouth. The impression caps fixed in the impression are sent to the laboratory.

The patient can be provided with a simple, temporary denture fabricated at the chairside until the incorporation of a final crown or bridge.

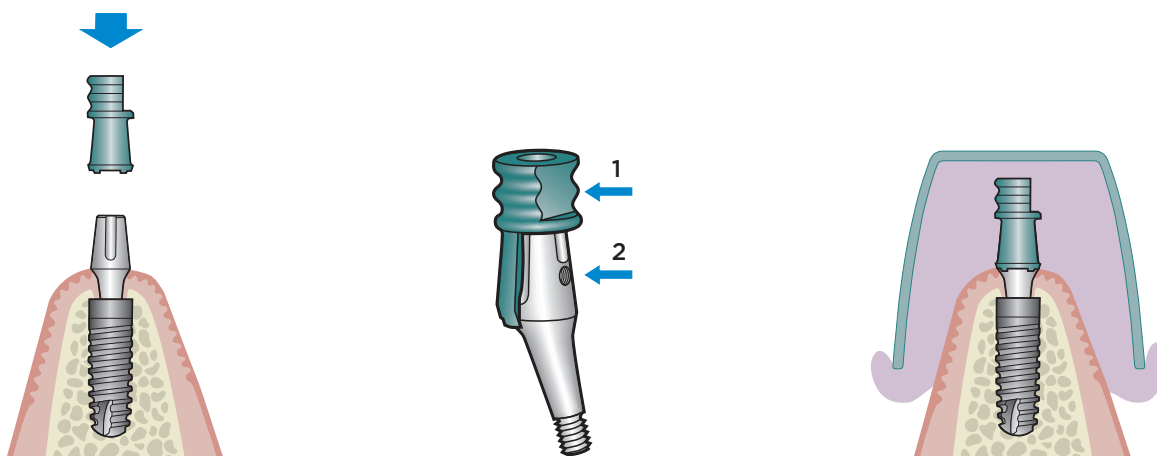

### Impression with the Ankylos Standard transfer cap

The impression of the abutments incorporated in the implants is taken using transfer caps. These are disposable articles, multiple usage will affect the precision. The synthetic transfer caps must not be sterilized. Integrated retention grooves guarantee secure positioning of the caps on the abutments or the laboratory analogs. The transfer caps can be used for straight and angled Standard abutments with the same head design.

For 15° abutments, the flattened side (1) of the transfer cap should be adjusted via the lateral screw thread (2).

The impression is taken as usual. Since the impression cap remains in the impression, hydrocolloid cannot be used as the impression material.

The impression is sent to the laboratory for casting the model.

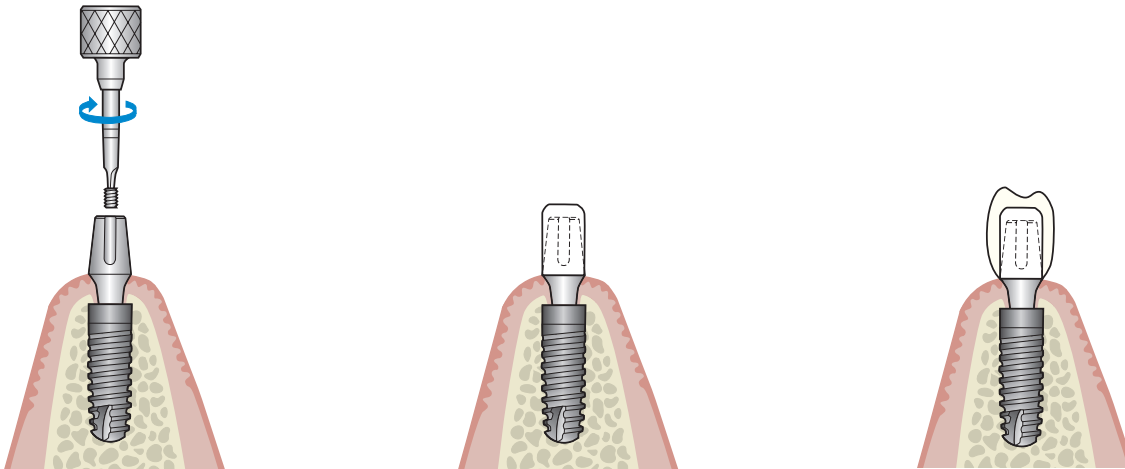
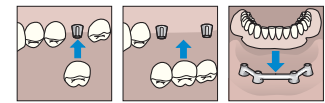

### Temporary restoration

To protect the occlusal thread of the straight abutment, seal the opening with a headless screw (order no. 3105 6010).

Temporary caps made from synthetic material enable fast and straightforward fabrication of provisionals at chairside, using a thermoformed splint, or in the laboratory. The temporary caps can be used for straight and angled abutments. The edges taper out markedly and do not need further elaboration.

## Step-by-step: Delivery of the prosthetic restoration

Cemented and screw-retained crowns and bridges, as well as bar-supported overdentures can be fabricated on Ankylos Standard C/ abutments.

These are screwed occlusally onto the straight abutments and laterally onto the angled abutments already incorporated into the patient's mouth.

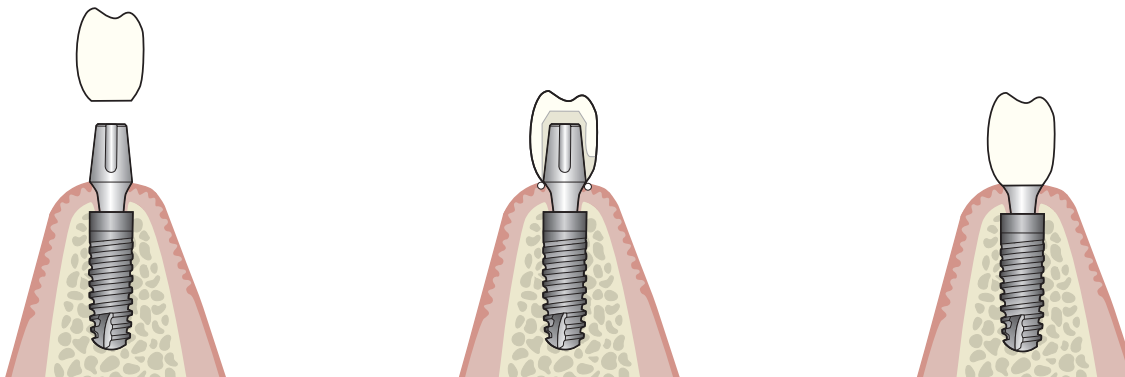

### Cemented crowns or bridges

For straight abutments, the occlusal inner thread on straight abutments should be protected by sealing with a headless screw (order no. 3105 6010). For angled abutments, seal the free space over the central straining screw using gutta-percha, cement, a cotton pellet or similar.

After fitting and checking the tension-free fit, the prosthetic restoration is cemented onto the abutment(s). Phosphate cements or temporary cements can be used. The manufacturer's directions should be observed here.

Ensure that excess cement is thoroughly removed from the crown margin. Thick dental floss looped under the crown margin and around the abutment can prevent the cement overflowing.



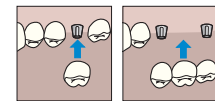

## Step-by-step: Delivery of the prosthetic restoration

Cemented and screw-retained crowns and bridges, as well as bar-supported overdentures can be fabricated on Ankylos Standard C/ abutments.

These are screwed occlusally onto the straight abutments and laterally onto the angled abutments already incorporated into the patient's mouth.

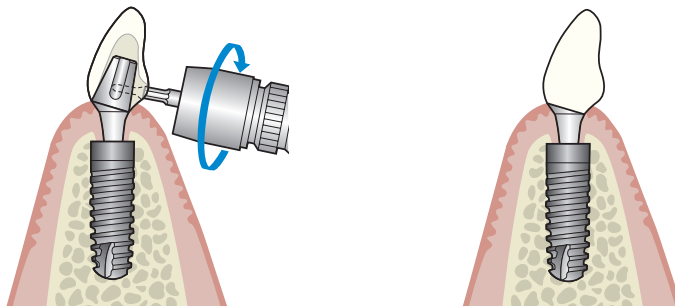

### Laterally screw-retained crowns or bridges (angled abutments)

The free space over the central straining screw of the angled abutment should be sealed with gutta-percha, cement, a cotton pellet or similar.

After fitting and checking the tension-free fit, the prosthetic restoration is laterally screw-retained with the M 1 x 0.2 lateral hex retaining screw. The insert for the prosthetic ratchet with the 1.0 mm hex screwdriver, short, should be used with the prosthetic ratchet for this.

Once the torque is reached, the torque insert disengages and will no longer turn. Alternately, the 1.0 mm hex screwdriver insert can be used with a torque-controlled contra-angle handpiece.

The recommended torque for lateral screw-retention is 10 Ncm.

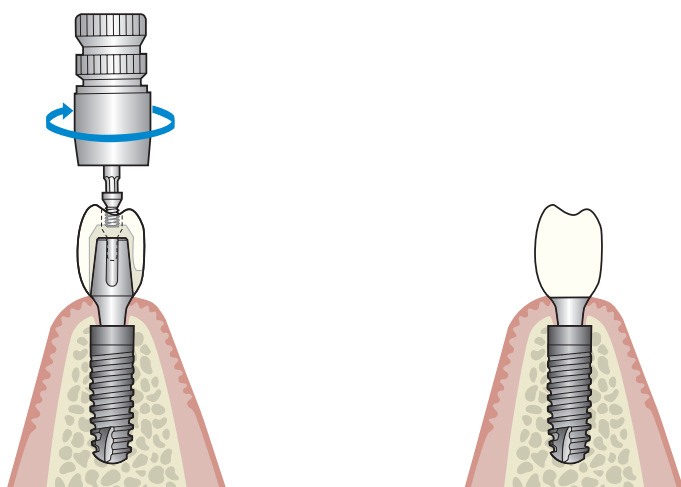

**Occlusally screw-retained crowns or bridges (straight abutment)**

Unscrew the headless screw from the abutment. The 1.0 mm hex screwdriver insert in the screwdriver handle is used for this. Alternately, the screwdriver can be used in a torque-controlled contra-angle handpiece or the 1.0 mm hex screwdriver can be used. After fitting and checking the tension-free fit, screw-retain the crown or bridge with the occlusal M 1.6 mm hex retaining screw (order no. 3105 6021). The insert for the prosthetic ratchet is used for this with the 1.0 mm hex screwdriver, short, with the prosthetic ratchet.

Once the torque is reached, the torque insert disengages and will no longer turn. Alternately, the 1.0 mm hex screwdriver insert can be used with a torque-controlled contra-angle handpiece.

Where the walls are thicker (veneering), seal the cylindrical access to the screw head with composite after tightening. Here, the individually shortened wax-up screw (order no. 3104 5211/ short or 3104 5213/ long) can be employed as a long-headed screw.

Where the occlusal space is very limited, the slot-headed screw gold copings, 1.6 mm (order no. 3105 6140) can also be utilized. Wax-up screws and screws for gold copings are tightened using the 1.6 mm screwdriver blade insert, which is attached in the handle. The recommended torque for occlusal screw-retention is 10 Ncm.



Notes





### About Dentsply Sirona Implants

Dentsply Sirona Implants offers comprehensive solutions for all phases of implant therapy, including Ankylos®, Astra Tech Implant System® and Xive® implant lines, digital technologies, such as Atlantis® patient-specific solutions and Simplant® guided surgery, Symbios® regenerative solutions, and professional and business development programs, such as STEPPS™. Dentsply Sirona Implants creates value for dental professionals and allows for predictable and lasting implant treatment outcomes, resulting in enhanced quality of life for patients.

### About Dentsply Sirona

Dentsply Sirona is the world's largest manufacturer of professional dental products and technologies, with a 130-year history of innovation and service to the dental industry and patients worldwide. Dentsply Sirona develops, manufactures, and markets a comprehensive solutions offering including dental and oral health products as well as other consumable medical devices under a strong portfolio of world class brands. As The Dental Solutions Company™, Dentsply Sirona's products provide innovative, high-quality and effective solutions to advance patient care and deliver better, safer and faster dentistry. Dentsply Sirona's global headquarters is located in York, Pennsylvania, and the international headquarters is based in Salzburg, Austria. The company's shares are listed in the United States on NASDAQ under the symbol XRAY.

Visit [www.dentsplysirona.com](http://www.dentsplysirona.com) for more information about Dentsply Sirona and its products.

THE DENTAL  
SOLUTIONS  
COMPANY™

