

Ankylos[®]

SynCone[®] Manual



SynCone[®] C/

Stable prostheses for immediate and delayed restorations: The SynCone[®] concept

Ankylos SynCone C/ 5° abutments provide fast and cost-efficient restorations of the edentulous mandible with an immediately loaded prosthesis on four prefabricated taper abutments placed interforaminally. The minimally invasive treatment makes it possible to deliver the prosthesis to the patient still under anaesthesia. For delayed restorations Ankylos SynCone C/ 5° serves as a prefabricated retaining element for prostheses in the mandible and maxilla. New abutment angulations allow improved parallelization. Intraoral bonding ensures tension-free seating (passive fit) of the prosthesis.

The advantages:

- Permanent and yet removable
- Easy to clean
- Offers the comfort of a bridge
- Maximum possible reduction of the prosthesis body (free palate)
- Immediate restoration possible in 2 hours with existing prosthesis
- Virtually wear-free
- Relatively inexpensive for the patient
- Ankylos TissueCare concept provides long-term stability for hard and soft tissue*.

*Ankylos offset tapered implant abutment-connection provides long term hard and soft tissue stability over a mean period of 56 months as demonstrated by Nentwig's clinical observation of no progressive bone or peri-implant mucosa loss in 95.8% and 97.8% of 5439 cases respectively. [Nentwig, G.H., Ankylos implant system: concept and clinical application. J Oral Implantol, 2004. 30(3)]

CONTENTS

Ankylos® SynCone® concept

The tapered crown principle 4

Ankylos® SynCone® immediate restorations

Preparation of the implant site and placement of implants 6

Immediate restoration with existing prosthesis 10

Ankylos® SynCone® delayed restorations

Prosthesis with Ankylos SynCone on osseointegrated implants 18

Impression taking 20

Model casting 22

Selection of prosthetic abutments 24

Fabrication of metal framework 26

Intraoral bonding 28

Preparing and inserting the prosthesis 30

Ankylos® SynCone® system components

Components and instruments 32

Please read this manual carefully prior to using the system for the first time and follow the instructions and notes given in the instructions for use for the system components and instruments under all circumstances. Prior to using a new implant system for the first time we also recommend all users to attend system-specific training.

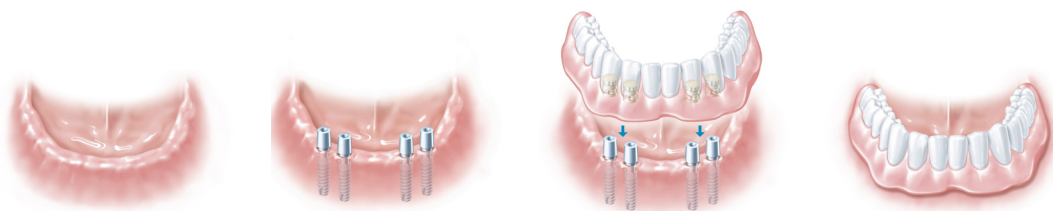

The tapered crown principle

Ankylos SynCone transfers the clinically proven stability of the tapered abutment connection to the abutment-prosthesis connection. This second tapered connection ensures that the final restoration is tightly seated minimizing gaps and micromovement. Compared with bar restorations or other prefabricated connecting components, SynCone tapered crowns offer a stable and friction-locked connection that helps to eliminate problems often associated with edentulous jaws, such as:

- Pain of pressure of ill-fitting dentures
- Atrophy as a result of inactivity or pressure
- Continued bone loss requiring relining of existing denture
- Design-related difficulties with the mesostructure

A connection with a tapered cone design serves as a retaining element where the tapered cap is retained on a tapered abutment by surface contact. When the retention is disconnected, the prosthesis is released, allowing for easy removal. In contrast, a parallel-walled, telescopic design creates a friction throughout the complete path of insertion.

Patients find it easier to insert a prosthesis with tapered connection design, because the bottom diameter of the tapered caps connected to the denture is always larger than the top diameter of the abutments.

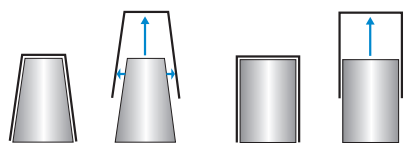

Simplified insertion and removal of the prosthesis with tapered abutments (left) in comparison with parallel-walled retaining elements (right)

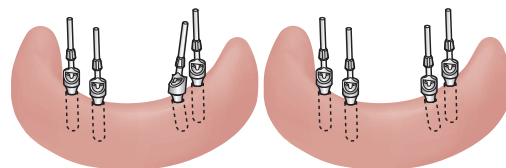

Creation of a common direction of insertion for abutments with non-indexed, tapered connection

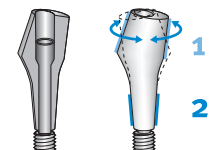

The synergy of the two tapers

The tapered TissueCare connection allows for free 360° alignment of the non-indexed abutments in any position. This enables aligning angled abutments by rotation until the insertion direction of the prosthesis has been reached (staggered-taper principle).

Ankylos SynCone abutments have an integrated, mobile straining screw so that the taper of the abutment head can be rotated in the connection taper of the implant as needed to form a common direction of insertion.

Advantages for patients

The tapered crown principle effectively makes the prosthesis into a removable bridge with:

- Very high stability
- High chewing comfort
- Reduced prosthesis base
- Improved phonetics
- Optimum hygiene capability

Ankylos® SynCone® in immediate loading

SynCone is ideal for the requirements of a geriatric immediate loading concept. The patient can leave the dental clinic with a fixed prosthesis as little as two hours after the start of the treatment. SynCone offers the practitioner key advantages:

- Reduction of the total treatment time
- Simplification with prefabricated components for chairside procedure
- Clinically proven suitability of Ankylos implants for immediate loading with an innovative prefabricated application of the telescopic crown technique

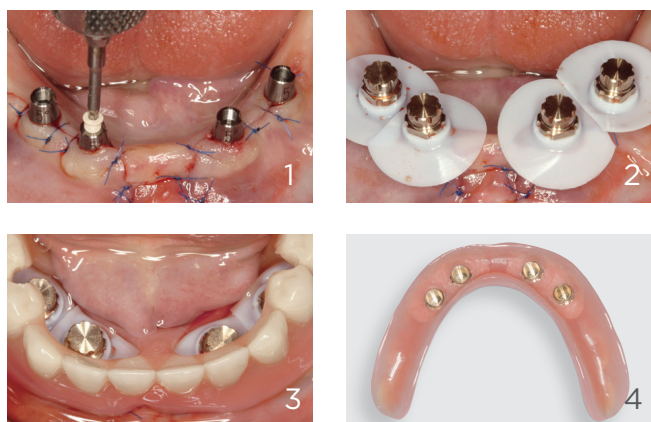

1-4 | Immediate restoration of the edentulous mandible with Ankylos SynCone (courtesy of Dr. Dittmar May, Lünen/D, dental technique: Dental Laboratory Alt & Schmidt GmbH, Lünen/D)

Ankylos® SynCone® in delayed loading

If immediate loading is not possible or not required, SynCone has several advantages when used on healed implants:

- Tension-free seating (passive fit) with intraoral cementing of the taper cap to the framework
- Simplification with prefabricated components for chairside procedure
- Prosthesis retention is superior to a bar milled by a time-consuming process and also much more economical
- Improved hygiene for patients



5-8 | Delayed restoration with laboratory-reinforced prosthesis on healed implants (courtesy of Dr. Dittmar May, Lünen/D, dental technique: Dental Laboratory Alt & Schmidt GmbH, Lünen/D)

SynCone compared to other removable restoration options

	Bar	Snap attachment	Locator	SynCone
Hygienic capability of the suprastructures	complicated	easy	easy	easy
Anchorage principle	friction via different bar attachments	metal matrix on metal sphere	replaceable nylon matrix on titanium matrix (push button)	prefabricated taper with prefabricated abutment
Activation of retention elements	limited	limited	not possible	not required as virtually wear-free
Replacement of retention elements	from complicated to easy – depending on design	complicated	very easy	not required as virtually wear-free
Compensation of angular placed implants	complicated	slight divergences are possible	easily possible	easily possible

Dr. Mischa Krebs, Prosthetic restoration options for edentulous jaws, published in: pip – Praktische Implantologie und Implantatprothetik, 2/2011, p. 49



Immediate restoration

Immediate restorations with Ankylos[®] SynCone[®] C/

The treatment concept in the edentulous mandible with immediately loaded Ankylos implants, as described on the following pages, requires interforaminal insertion of four implants with a minimum length of 11 mm and the use of SynCone abutments with 5° taper.

A prerequisite for the successful application of the Ankylos SynCone concept is a prosthesis with optimal fit and occlusion as well as the parallel axial alignment of the SynCone abutments.

The implants can be inserted either conventionally or as part of Guided Surgery. Computer-guided planning and template-guided insertion of the implants increase the precision of the parallel axial alignment of the implants later on.

Both protocols are described in the following pages. Please refer to the Ankylos Surgical Manual, for detailed instructions on the placement of implants.



Step-by-step: Conventional preparation of the implant site

The implant site is prepared up to the implant-specific diameter using internally irrigated, motor-driven instruments.

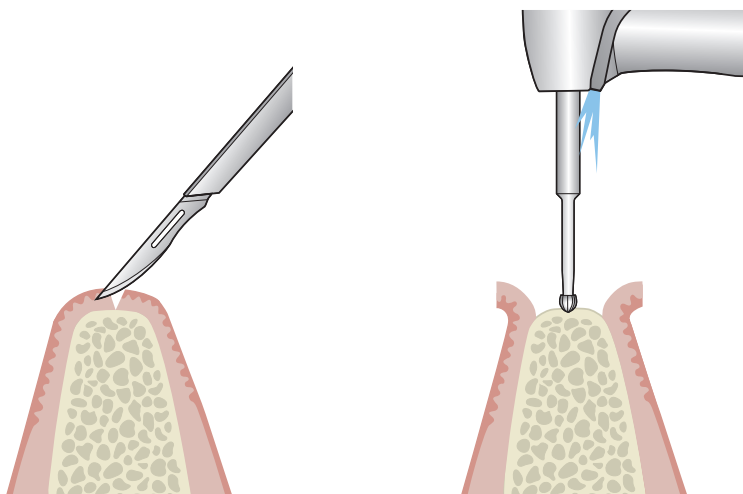

Incision direction

The bone is uncovered by incision. The mucosa and periosteum are mobilized and folded back. The direction of the incision is case-dependent and needs to take the healing mode into consideration (transgingival or covered).

Bone smoothing

After mobilization of the muco-periosteal flap, sharp bone crests are smoothed slightly using an internally irrigated round drill.

The Ankylos round drill and the twist drill are operated at max. 1500 rpm (revolutions per minute).

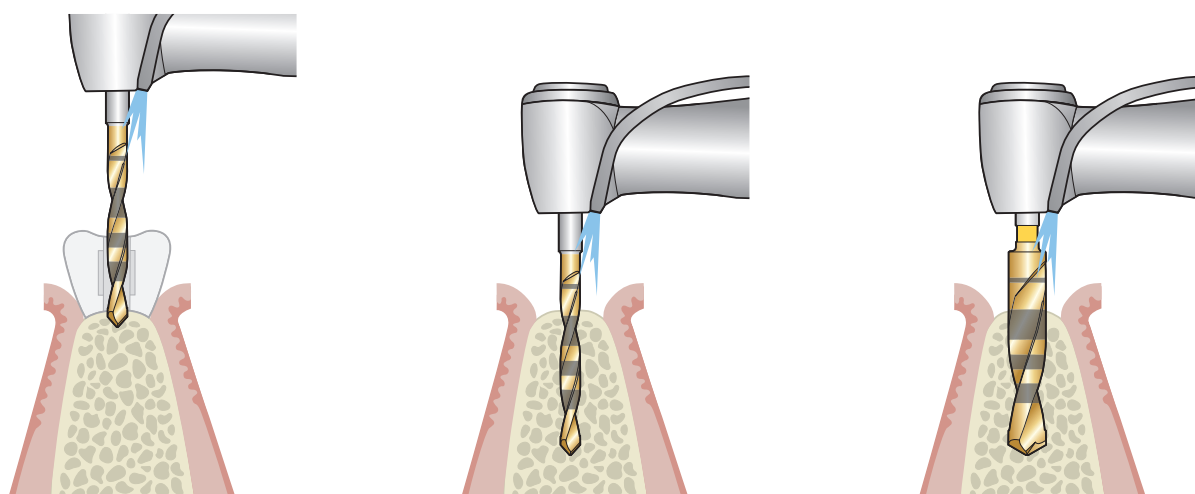

Marking implant position

The drill guide is placed and the implant position transferred to the bone using the twist drill (Lindemann drill optional). The titanium sleeve for drill guides (order no. 3104 5490) can only be used in conjunction with the twist drill.

Pilot hole with twist drill

After removing the drill guide, the twist drill is used to determine the direction of the implant. Depending on the ridge profile, the axial direction can deviate within limits from that specified by the implant template. Any axial divergence can be compensated later with angled abutments.

Depth drilling

Depth drilling is performed with twist drills. The upper edges of the ring markings correspond to the implant lengths. The twist drill A is always used first. When using B, C or D implants, the hole is consecutively widened using the twist drills B, C or D. In case of increased bone density care should be taken to proceed atraumatically and with slight pressure.

Primary stability

If immediate function is achieved the torque should be at least 35 Ncm to provide sufficient primary stability. For better tactile control of the screwing resistance we recommend manual bone preparation and insertion of the implant using a torque-controlled ratchet.

If sufficient primary stability cannot be achieved, immediate loading is not recommended. In this case the implants are sealed with cover screws for submerged healing. Prosthetic restoration is then performed as part of delayed restoration as described from page 18.

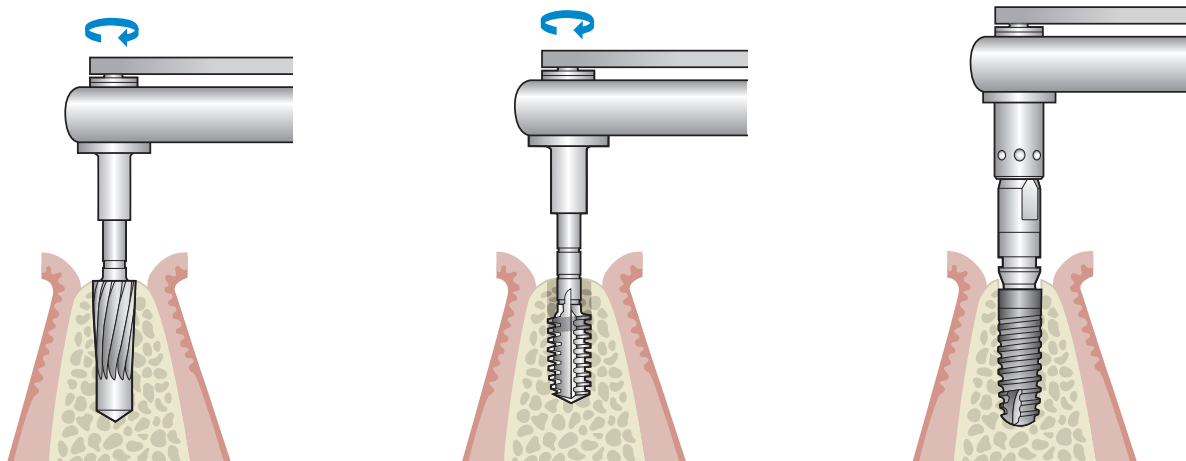

Manual use of reamer

The reamer and ratchet insert for instruments are joined to the required length and inserted into the ratchet, whereby the arrow on the switch button of the ratchet faces in the direction of rotation. The pin on the open end wrench acts as a guide to prevent any tilting of the instruments. The conical reamer is guided into the cavity and preparation commences without applying pressure. Only during the final quarter can preparation be supported by applying slight pressure. The non-cutting tip prevents the deepening of the hole. Prior to removal, the reamer should be rotated by a single revolution counterclockwise.

Manual use of the tap

The tap corresponding to the implant diameter is joined to the ratchet insert for instruments in the required length and inserted into the ratchet.

The Ankylos thread is prepared clockwise. The depth is checked by the depth markings of the tap and the preparation is stopped at the correct depth. On completion of thread preparation the tap is screwed out of the implant site counterclockwise and the cavity is rinsed again with physiological saline solution.

Screwing in implant manually

The implant driver of the desired length is fitted with the screw handle of the ratchet insert to remove the implant from the implant shuttle. The implant is screwed into the jaw bone for about two thirds of its length. Make sure that no fibrous or epithelial tissue is transferred to the implant site. Final positioning is performed with the ratchet.

If preparation and insertion by machine are preferred for exact torque control, please follow the instruction in the Ankylos Surgical Manual.

Step-by-step: Preparation of the implant site with Guided Surgery

Planning and drill guide

Implantation is planned using the 3D scan and the Simplant software. An individual Simplant Safe Guide is then prepared from the digital planning data via a stereolithography.

This ensures the fully and accurately transfer of planning to the patient's mouth.

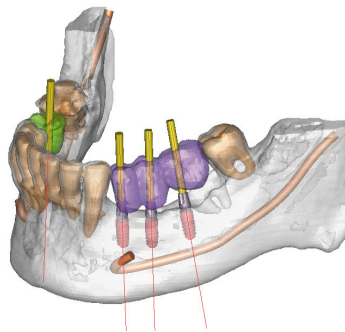

(Photos: Van Ghemen Dental Labor, Berlin/D and Praxis Dr. Dhom und Partner, Ludwigshafen/D)

Scan template/scan

With the 3D scan of the patient and the scan template via CT (computer tomography) or DVT (digital volume tomography), the Simplant software not only displays the patient's jaws, but also the planned arrangement of teeth as a 3D model.

3D planning with Simplant

With the Simplant software all relevant information for implantation can be determined for any area of the jaw and the implant position and size are planned accurately and securely.

Simplant Safe Guide

The appropriate Simplant Safe drill guide is ordered for the planned restoration procedure of the edentulous mandible.

Flapless surgery

As Simplant allows accurate planning of the implementation with a display of the anatomical structures, minimal invasive flapless surgery is, of course, possible with adequate bone volume and sufficient keratinized gingiva. A mucosa-supported drill guide is used for this purpose.

Flap surgery

If the bone is to be uncovered for implantation purposes, a bone-supported drill guide is used. This provides an optimal, genuine fit on the jaw bone.

Surgical procedure

The following step-by-step instructions describe the template-guided preparation of the implant site with insertion of the implants without open flaps of the mucosa (flapless surgery).

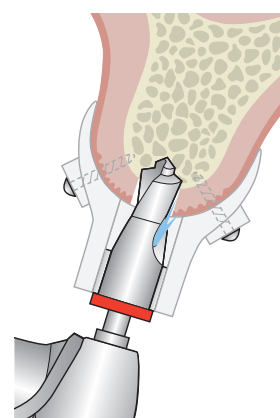
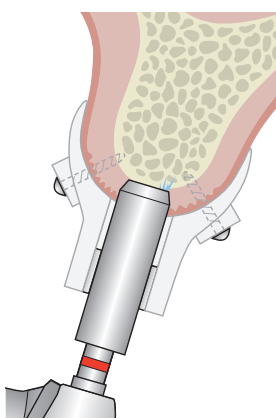
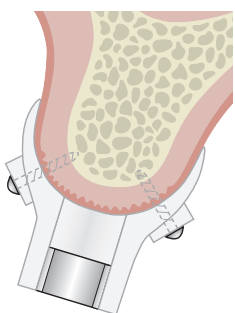

Fixing the template

The mucosa-supported Simplant Safe Guide guide is placed in the patient's mouth and checked for accurate and stable fit. The drill guide is then fixed vestibularly, if required also palatally or lingually, at the intended positions on the jaw.

Punching of the mucosa

Using the Ankylos mucosa punch GS, a minimal invasive circular incision is performed with the diameter of the implant to the coronal bone level.

Initial drilling

Using the Ankylos initial drill GS, the mucosa and the coronal bone up to the implant shoulder are removed and center-punched. The pilot drill is guided directly in the guide sleeve.

All twist and Tri-Spade drills are guided accurately in the Siplant Safe Guide via the Sleeve-on-Drill system using a guide sleeve fixed to the instrument.



All twist and Tri-Spade drills for implants A8-14 and B8-14 are available for the specific length of the implant (final length drills). Thus, the shortest possible drill can always be used in case of limited space.

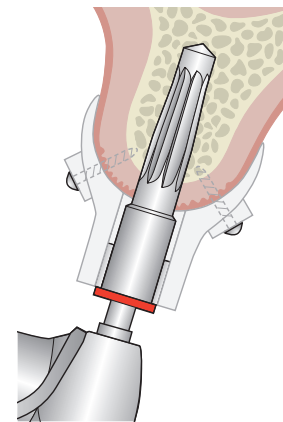
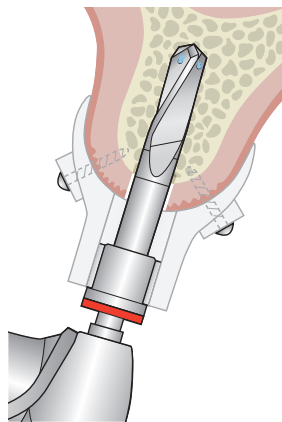
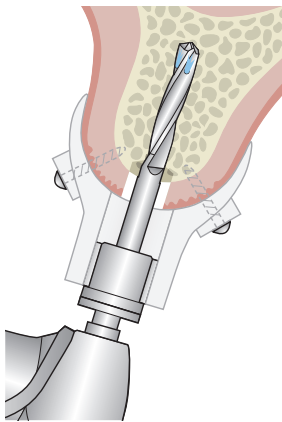

Pilot drilling

The drill with the smallest diameter, the Ankylos twist drill GS D 2.0, is used for pilot drilling. The drill is selected according to the planned implant length. It is used together with a Sleeve-on-Drill drilling sleeve, and, like all drills, is fitted with a mechanical depth stop which ensures that the planned drilling depth is not exceeded.

Expansion drilling

The Ankylos Tri-Spade drills GS A and B are available for the implant lengths and diameters. The stepwise preparation of the implant site is performed up to the planned implant diameter. The Tri-Spade drills are used according to the length of the planned implant.

Crestal bone preparation

The Ankylos conical reamer GS serves the conical enlargement of the depth drilling in the crestal region and is guided directly in the guide sleeve.

Be mindful of sufficient internal instrument irrigation during the preparation. The opening for the internal irrigation can be obstructed by bone chips during the preparation. Hence, particularly where multiple cavities are prepared in succession, checking the uninhibited coolant flow outside of the guide regularly and, if required, clearing the opening using the drill cleaning instrument are recommended.

Where the instruments become damaged or blunt, replace these; replace the instruments, however, after not more than 20 uses. Only use the twist drill with a suitable drilling sleeve. Use each drilling sleeve for a maximum of 10 drilling procedures on the same patient. Dispose of all used drilling sleeves immediately after completing the procedure, as the sleeves may later be difficult or not possible to remove from the drill due to adhesion.

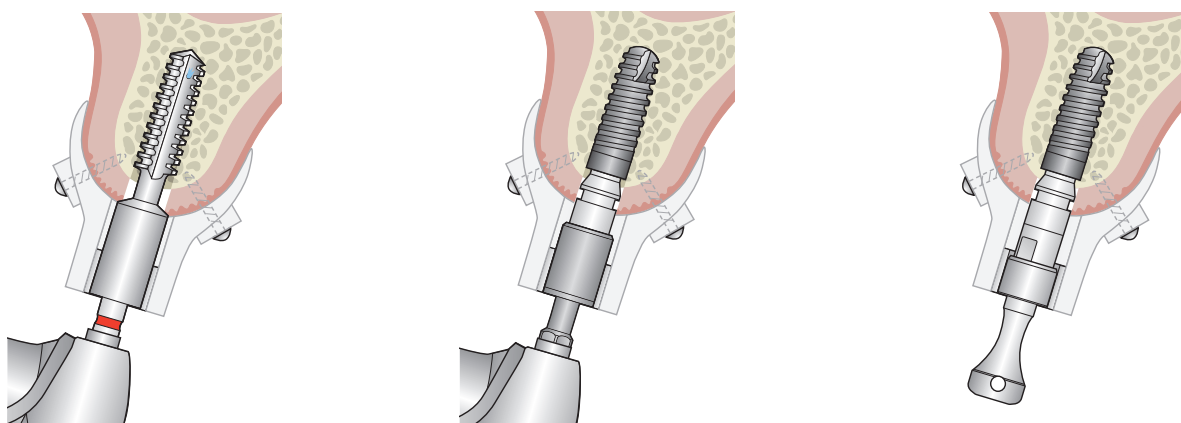

Tapping

Following crestal preparation, the implant thread is prepared using the Ankylos tap GS. In contrast to the previously used instruments, the tap is not fitted with a mechanical depth stop. The maximum preparation depth is achieved once the guide shaft is flush with the top margin of the guide sleeve.

Placing the implant

The Ankylos implant is inserted to the planned insertion depth using the Ankylos implant driver GS. The planned position of the implant is achieved once the cylindrical section of the implant driver is flush with the top margin of the guide sleeve.

Securing the drill guide

Prior to inserting further implants, the guide is secured against horizontal shifting using the stabilization abutment for the placement head.

At least the first two implants must be prepared, placed and provided with a stabilization abutment in succession before further implants are placed.

Since the tap does not have a mechanical depth stop, the visual control of the maximum preparation depth must be observed in any case. If the tap is screwed in too deeply, there is the risk of damaging anatomical structures and nerves.

Step-by-step: Immediate restoration with existing prosthesis

The prosthesis is to be integrated chairside immediately after insertion of the Ankylos implants and the SynCone abutments. Laboratory-supported incorporation of the caps via impression taking and model casting is not scheduled as part of immediate restoration.

To this purpose the placement heads are removed from the implants by loosening the straining screw of the head using the 1.0 mm hex screwdriver. Then remove the placement heads from the mouth. Safeguard against swallowing or aspiration.

Selection and axial alignment of the abutments

In one prosthesis, only SynCone abutments with the same tapered angle may be used. A prerequisite for the successful application of the SynCone concept is the parallel axial alignment of the SynCone abutments (Fig. above). If the taper surfaces are parallel due to diverging SynCone abutments, this can cancel taper retention and lead to increased retention (Fig. below).

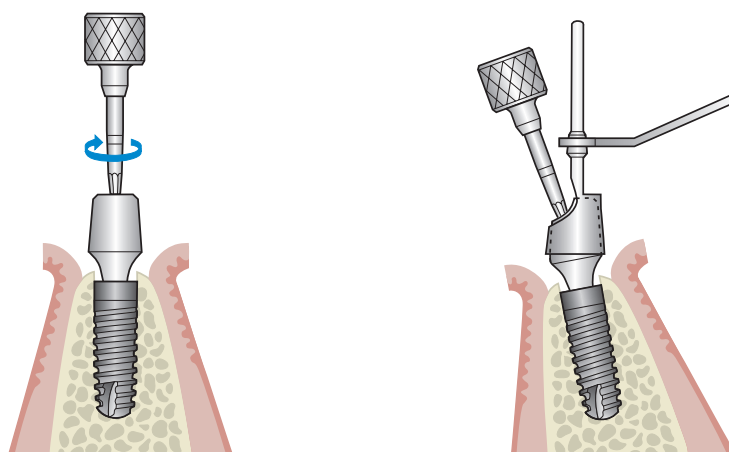
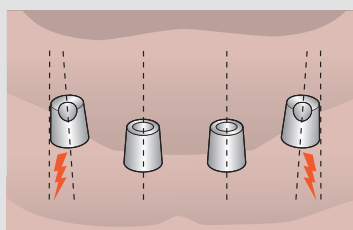
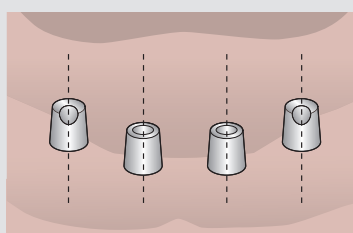

Screwing in of Ankylos SynCone C/ abutments

The selection of SynCone abutments with 5° tapered angle (optional 4°) depends on the thickness of the mucosa. Prior to placing the SynCone C/ abutments ensure that the inner taper of the implants has been rinsed carefully and dried. The SynCone C/ abutments are to be sterilized prior to placement.

The abutments are then screwed into the implants using the 1.0 mm hexagon screwdriver. The torque-wrench with hex insert or a torque-controlled contra-angle handpiece serve this purpose. The recommended torque for the straining screw is 15 Ncm.

Aligning the insertion direction of the abutments

For diverging implants, the direction of insertion can be adjusted using angled SynCone abutments.

Using SynCone parallel gauges, the abutments are aligned axially parallel to each other (at least 1° taper over all surfaces).

The positioning key for angled standard abutments included in the prosthetic tray, which is fixed to the shaft of the gauges, can be used to screw in the abutments via the parallel gauges.

7.5°-angled abutments have to be screwed in first with the 7 mm screw handle, then remove the parallel gauge and tighten straining screw with 15 Ncm.

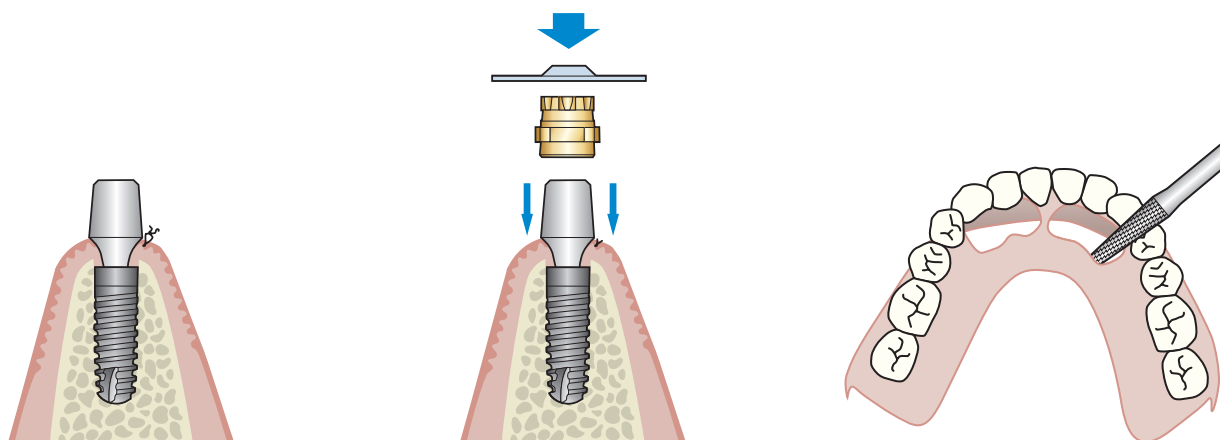

Closing the screw channel, wound closure

In the case of straight SynCone abutments with a 5° tapered angle, the hole of the screw channel is to be sealed with the cover screw for the SynCone C/ abutment 5°. For angled abutments this is done with thermoplastics. Then, close the wound edges saliva-tight by carefully suturing with monofilament suture material. The abutment geometry, with its convex sulcus section, allows tight peri-implant attachment of the mucosa, resulting in elevation of the wound edges in the irritation-protected transmucosal zone of the abutment. The clinical result after a short period is a well attached, fibrous wound edge.

Attaching Ankylos tapered caps with retention

Sterilize the prefabricated Degulor tapered caps with retention for SynCone according to the instructions for use and place them firmly on the SynCone abutments. The retention profile serves for attachment to the plastic base of the prosthesis. Caps without retention may not be incorporated into an existing prosthesis. Then pull the flexible SynCone polymerization sleeve over the cap to below the abutment equator. This prevents any cold-cured polymer from penetrating between cap and abutment or the sulcus region of the abutment and protects the soft tissue. Alternatively, a cofferdam curved incision can be carried out in the same manner.

Preparing the prosthesis

The prosthesis to be incorporated must match the available mandibular mucosal tegument and meet functional chewing and esthetic requirements. The prosthesis must be ground sufficiently to avoid imperfections on the caps. It also serves as a drilling guide. At the same time grinding should be kept to a bare minimum to avoid excessive polymerization shrinkage. Extended functional margins can be shortened as far as possible.

If the prosthesis is too loose, the following errors may have occurred:

- Trapped sutures
- Edges of caps not free of plastic
- Grouting of plastic in the cap
- Extended margins not shortened enough
- Patient moved prosthesis during polymerization

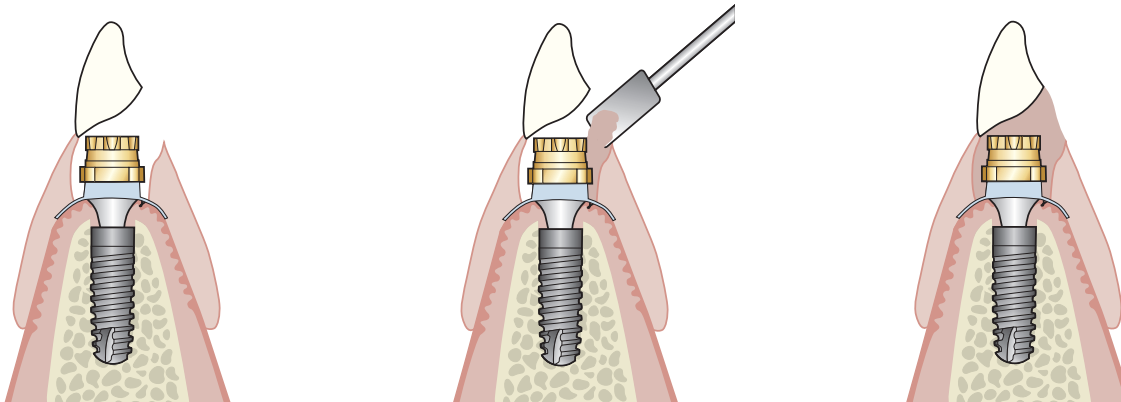

Inserting the prosthesis

The caps should be checked for a firm fit on the abutments in their final position prior to inserting the prosthesis. Check that no sutures are trapped when fitting the caps. Then insert the prosthesis. If the prosthesis is too loose, this results from too high pressure on the prosthesis during the polymerization phase. In this case, polymerization needs to be repeated.

Polymerization phase

The SynCone caps must be covered bubble-free and entirely with viscous blended cold-cured polymer to ensure stable long-term integration of the caps in the prosthesis body. To avoid misalignment of the caps in the prosthesis with resulting changes in occlusion, any transverse and/or vertical displacement of the prosthesis must be avoided during the polymerization process. A suitable clinical method to accomplish this, is to request the patient „to close his mouth (in habitual occlusion) and to keep the rows of teeth pressed

together gently, but properly (in their final occlusion position with tegument contact)“. Purely manual stabilization often results in occlusal changes. Biting down too hard can lead to a sinking of the prosthesis due to tegument resilience. The elasticity of the thus compressed mucosa and the joined masticatory muscles can inhibit the desired friction between the SynCone abutments and caps, in other words, loosen the prosthesis.

Long-term temporary denture

The solution with immediate restoration is to be regarded as a long-term temporary denture. After three to six months, the prosthesis is newly made with a metal reinforcement (see page 20 ff).

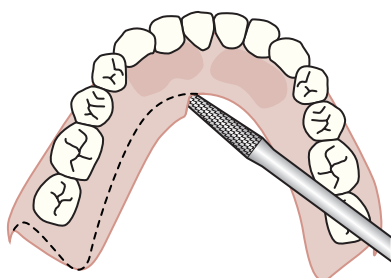

Finishing the prosthesis and shortening the functional margins

The autopolymerizate must be completely hardened prior to removing the prosthesis. Check for interference-free occlusion and articulation. For finishing and polishing, the prosthesis is removed from the oral cavity once the autopolymerizate has completely hardened. Ensure a clearance of 1 mm between the lower edge of the SynCone caps and the synthetic material and that the extended functional margins are trimmed thoroughly.

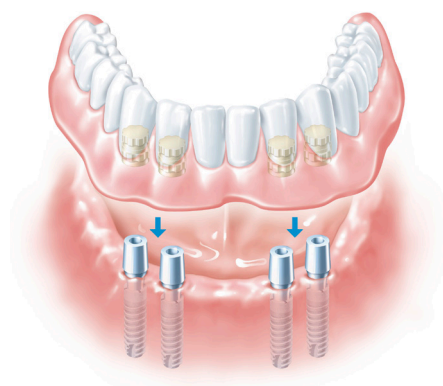

Inserting the prosthesis

The finished prosthesis is inserted and retention is checked.

The prosthesis must display the required taper retention without functional impairment. Any loosening of the complete denture by the patient moving the muscles of his tongue, floor of the mouth, or cheeks, must not be possible in order to ensure secondary splinting of the implants during the healing time.

Postoperative care with immediate loading

Instructions during healing – recommendations to the patient

- Wear the fixed prosthesis permanently for two weeks
- Take a soft diet for 14 days

The patient should use an anti-bacterial mouth rinse after meals. This serves the prophylaxis of infections as the insertion points of the implants can at first not be cleaned manually.

Further procedure after healing

The prosthesis is removed from the oral cavity by the dentist after one week when the sutures are removed, and then worn again for one week. Following this two week period, the patient is given detailed instructions on further oral and prosthetic hygiene and on the handling of his mandibular dental prosthesis.

After this period, a normal diet can be resumed. As usual, regular follow-up examinations are necessary to compensate for any deficits on the edges of the prosthesis (no padding).



Delayed restoration

Step-by-step: Prosthesis on Ankylos[®] SynCone[®] C/ on osseointegrated implants

A metal-reinforced prosthesis is fabricated for the final restoration of the patient

- As replacement for the long-term temporary denture after healing of the implants placed for immediate loading
- As part of the two-stage procedure after submerged implant healing

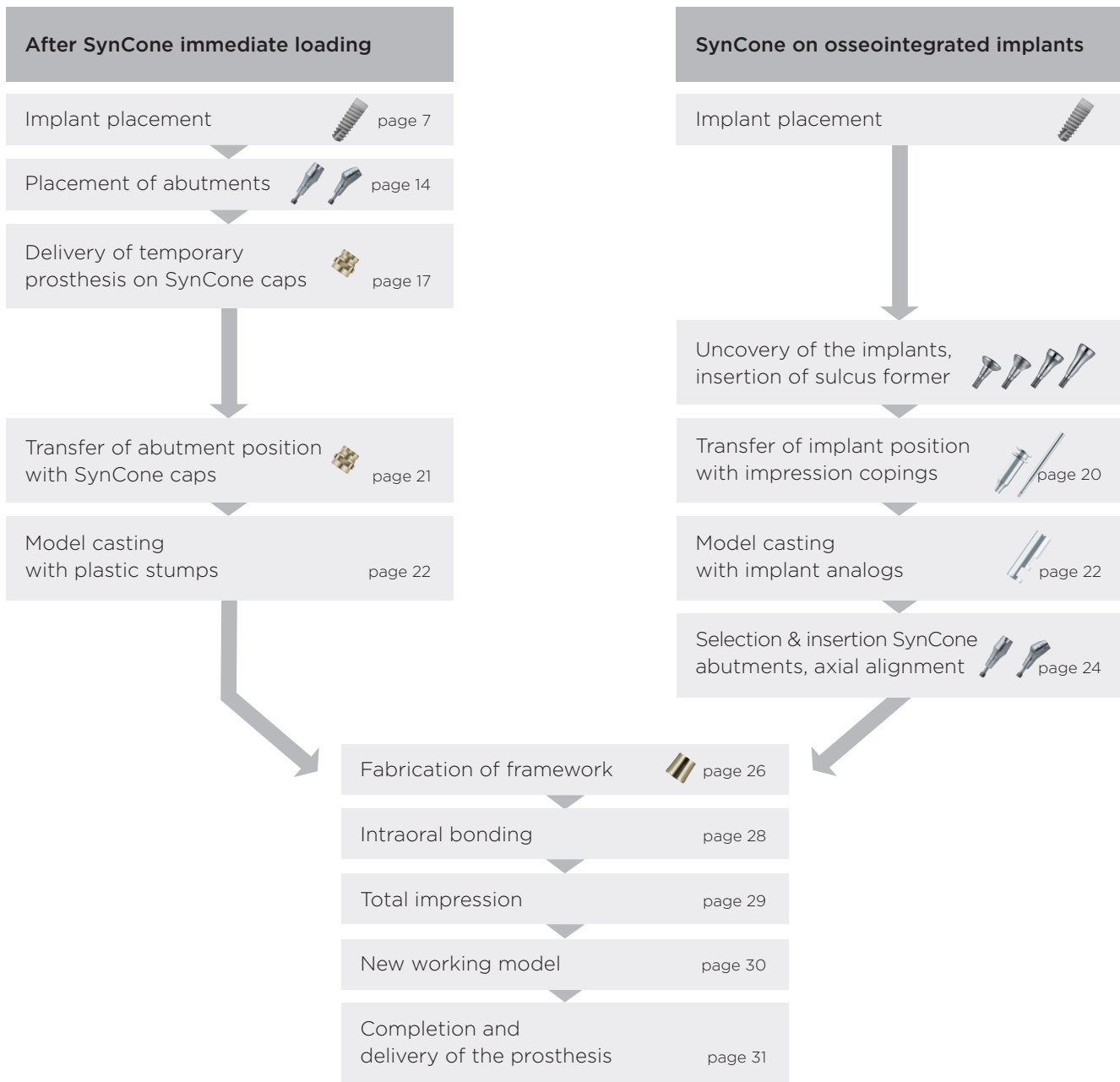

Step-by-step: Impression taking

After submerged healing and implant uncover, the impression is taken with components of the Ankylos Balance prosthetic range to transfer the implant position as described below.

After submerged healing

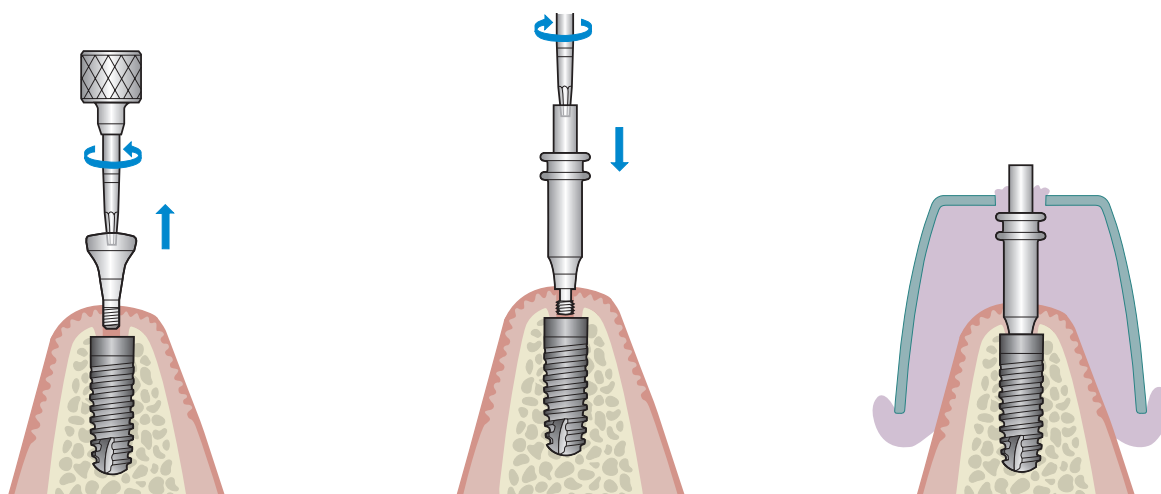

Implant uncover and healing of the soft tissue

Uncovery of the implants and removal of the Ankylos C/X cover screws is performed as described on page 28. Ankylos C/ gingiva formers D 4.2 are used for contouring the soft tissue (Balance Posterior sulcus formers for tapered angles 4° and 6°). These are hand-tightened with the 1.0 mm hex screwdriver and remain in situ for approximately 14 days. Sterilize the gingiva formers prior to use. The gingiva formers are removed for impression taking and the connection tapers cleaned of any residual tissue.

Impression PickUp technique (open tray)

The impression is taken using the components of the Ankylos Balance range and an open tray. Clean the connection taper of the implants of any residual tissue. Insert the transfer posts into the connection taper of the implants and attach with transfer screws of the desired length. Hand-tighten the transfer screws. The internal hex is only used here to loosen the screw. Ensure the fit of the transfer posts in the connection taper of the implants. If necessary, the transfer screws can be shortened and provided with a slot.

After the impression material has set, undo the transfer screws and remove the impression with the abutment.

The impression with the transfer screws is sent to the dental laboratory for casting the model with implant analogs.

The gingiva formers are reinserted until the SynCone abutments are incorporated at the next consultation.

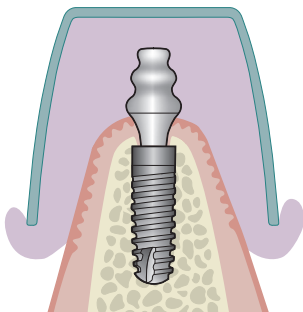

Alternative: Repositioning technique (closed tray)

If the implants intended for impression do not display any appreciable axial discrepancies, the transfer post can also be inserted using the repositioning technique as an alternative.

After immediate loading

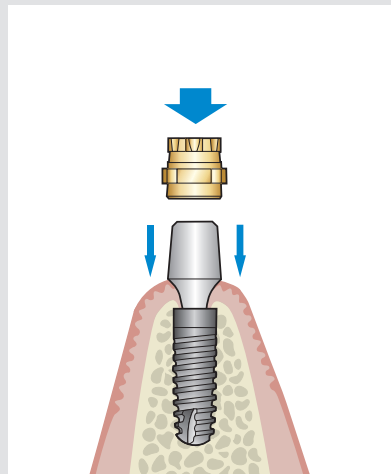

Simplified impression after immediate loading

First, the SynCone abutments are measured with a parallelometer using a plaster cast fabricated with an alginate impression. Here it should be ensured that the SynCone abutments do not display any parallel surfaces, especially divergences. If this is the case, impressions of the implants should be remade on the healed implants according to the protocol (page 16). The position of the SynCone abutments is transferred to the dental laboratory by means of the tapered caps for SynCone.

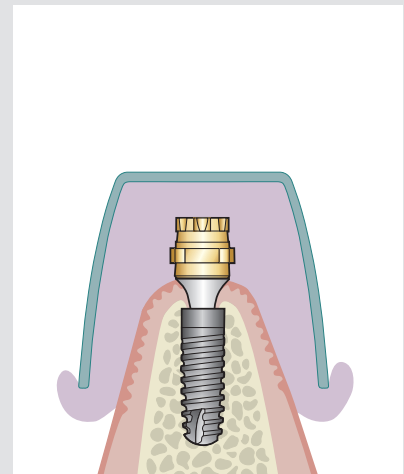

For impression purposes, the caps are to be positioned loosely on the abutment. These caps are later integrated into the new prosthesis. The impression is taken with a closed tray using silicone. After the impression material has set remove the impression and, if necessary, reposition the SynCone caps. The impression with the caps is sent to the dental laboratory for model casting. During the laboratory phase, the patient continues to wear the remodeled immediate loading prosthesis. After fabrication of the final prosthesis the patient can also use this as a replacement.

Step-by-step: Model casting

Casting the model after immediate loading

If the prosthesis is fabricated as replacement for the long-term temporary denture made from the old prosthesis, after healing of the immediately loaded implants simplified impression with SynCone caps is possible directly via the already incorporated Ankylos

SynCone abutments of the patient. The prerequisite for this, however, is that the SynCone abutments do not present any divergences or resulting parallel taper surfaces.

After immediate loading

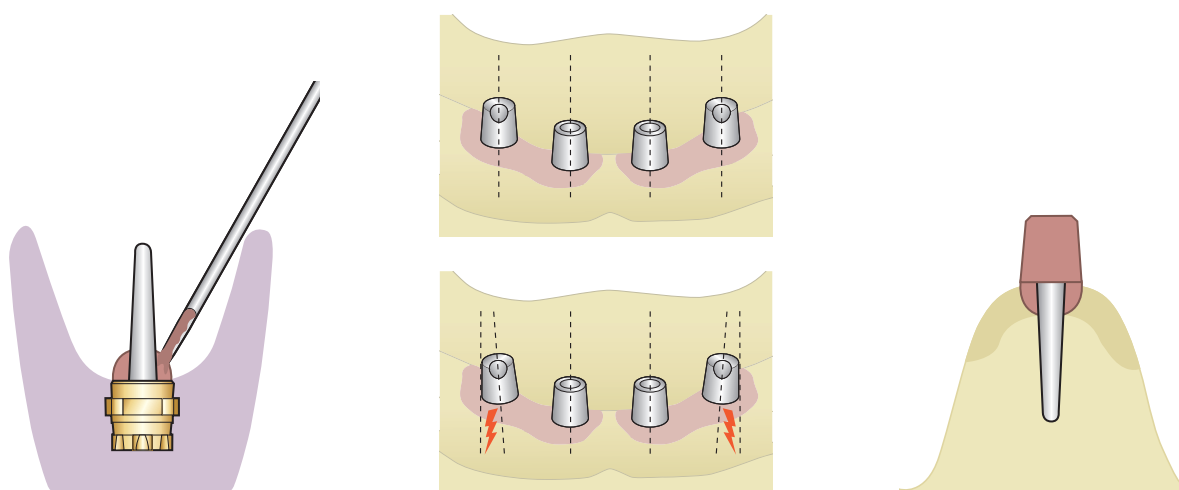

Casting the model

To fabricate the model, insulate the inner face of the Ankylos tapered caps for SynCone if necessary, fill with self-curing liquid plastic and fit a dowel pin. Then fill the impression with dental stone.

Check SynCone abutments

After casting the model based on the alginate impression the replicas of the SynCone abutments are measured with a parallelometer to ensure a common direction of insertion.

In the case of divergences and the resulting parallel tapered surfaces, a new impression has to be taken using Ankylos Balance C/ components according to the protocol for submerged healing.

Here it is to be insured that the abutments do not display any divergences or resulting parallel surfaces. After immediate loading or simplified impression via the SynCone caps, the selection and attachment of the abutments given on pages 24 - 25 is omitted. The plastic stumps created during the fabrication of the model serve as placeholders for the abutments in the model.

Please continue directly with the fabrication of the framework, see page 26.

Casting the model after submerged healing

If a prosthesis is fabricated following submerged healing, the components of the Ankylos Balance C/X prosthetic range, that is, the PickUp (open tray) or repositioning transfer abutments are used for the impression.

These are fixed in the Ankylos Balance C/ implant analog.

After submerged healing

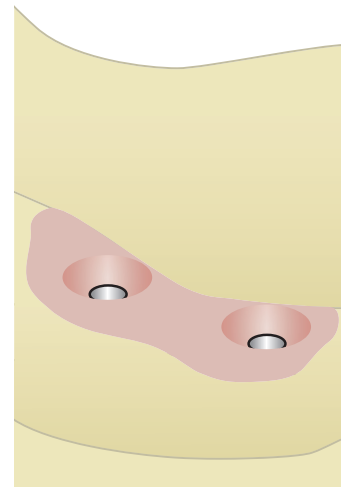
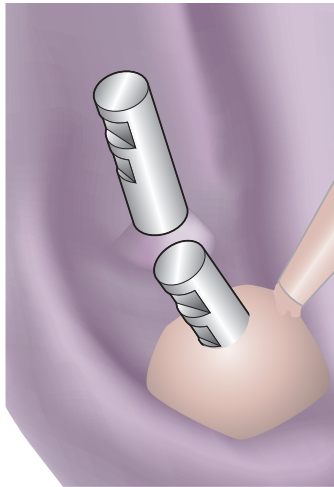
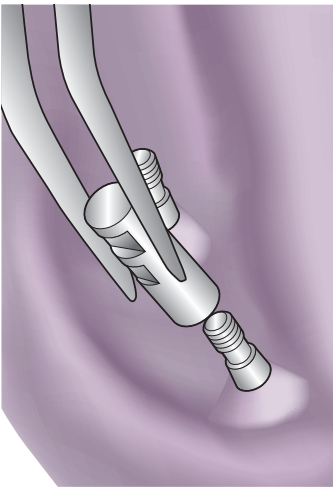

Fixing the Ankylos Balance C/ implant analogs

Screw the implant analogs to the transfer abutments fixed in the impression using the transfer screws.

Mucosa mask

Insulate the impression with silicone lubricant prior to casting and coat the area surrounding the implant analogs with gingiva casting material. Observe the manufacturer's instructions for use.

If the sulcus former is smaller than the abutment to be selected, the mucosa mask may impair the fit. In this case, fit the mucosa mask after selecting the abutment.

Casting the model

Fabricate the model using dental stone Class IV. Ensure sufficient height to cover the lower part of the implant analog with plaster. Then, undo the transfer screws and remove the impression.

Now the prosthetic abutments can be selected.

Step-by-step: Selection of prosthetic abutments

In the fabrication of the prosthesis following submerged healing or after impression taking using the components of the Ankylos Balance C/ prosthetics range, the Ankylos SynCone abutments are now selected and positioned. The steps shown on these two pages are omitted in the case of immediate

loading or simplified impression via the SynCone caps, as the abutments have already been incorporated in the patient's mouth. In this case, commence directly with the fabrication of the framework, as described from page 26 onwards.

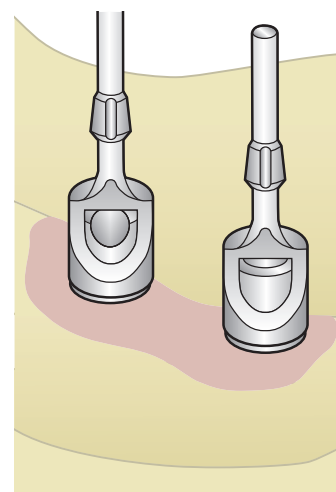
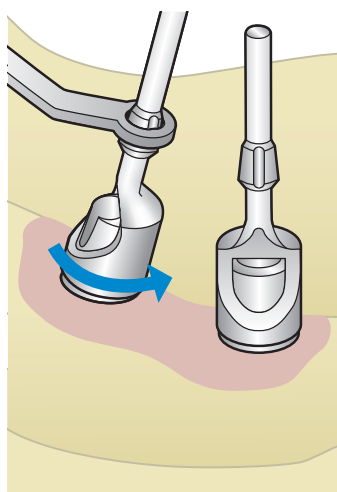
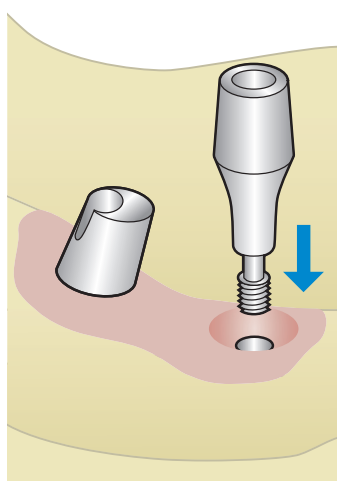

Selection of prosthetic abutments

Select the Ankylos SynCone abutments according to sulcus height and the angulation necessary to compensate for the axial divergence of the implants. The equator of the abutments should lie slightly supragingival. Screw retain straight abutments directly using the 1.0 mm hex laboratory screwdriver; insert angled abutments only into the implant analog.

Parallelization of abutments

Place the parallelization gauge on all abutments. For angled abutments, the parallelization gauge is to be placed such that the channel for the central straining screw can be accessed via the window.

Adjust the angled abutments to a common parallel direction of insertion in the parallelometer. Here, the positioning key for Standard angled abutments provided in the prosthetics kit, can be used as an aid for turning the abutments via the parallelization gauges. This key can be attached to the shaft of the gauges.

First, screw in the 7.5°-angled abutments with the 7 mm screw handle, then remove the parallelization gauge and tighten the straining screw with 10 Ncm using the laboratory screwdriver.

Only SynCone abutments with the same tapered angle may be used in a prosthesis. The prerequisite for a successful application of the SynCone concept is the common direction of insertion of the SynCone abutments.

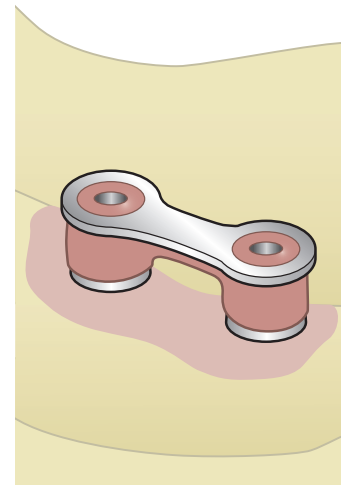
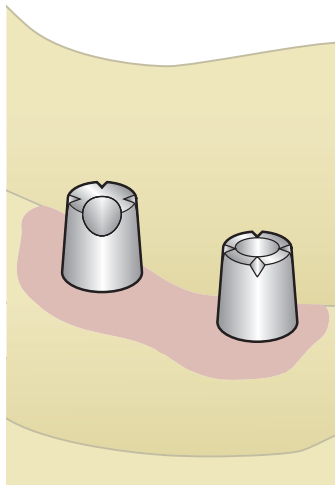
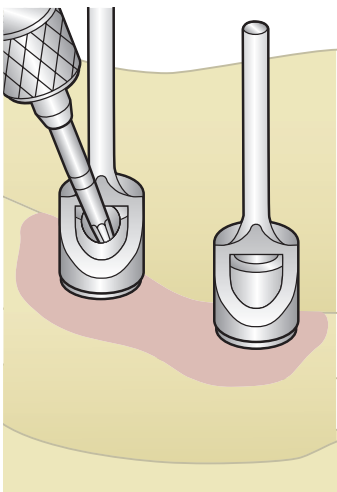

Screw-retention of the abutments, closing the screw channel

Following parallelization, screw the angled abutments in via the window using the 1.0 mm hex laboratory screwdriver. For straight SynCone abutments with a 5° tapered angle, the screw channel hole can be sealed with the cover screw for SynCone C/5° abutments in the patient's mouth. For angled abutments, self-curing thermoplastics are used for this purpose.

Marking the abutments

SynCone 5° abutments are grooved at the occlusal margin to hold these securely in the transfer key. To avoid misidentification, further small grooves can be added individually to the occlusal margin.

Transfer key

Once the abutments have been aligned, attached and grooved, a transfer key is fabricated. This can be fabricated entirely from quick-curing synthetic material and, if necessary, provided with a metal reinforcement, which is adapted using synthetic material.

Step-by-step: Fabrication of the metal framework

Regardless of whether the prosthesis is fabricated following submerged healing or after immediate loading on Ankylos SynCone abutments already in situ in the patient's mouth, all further steps for fabricating the framework and finishing the prosthesis are identical.

After immediate loading

After submerged healing

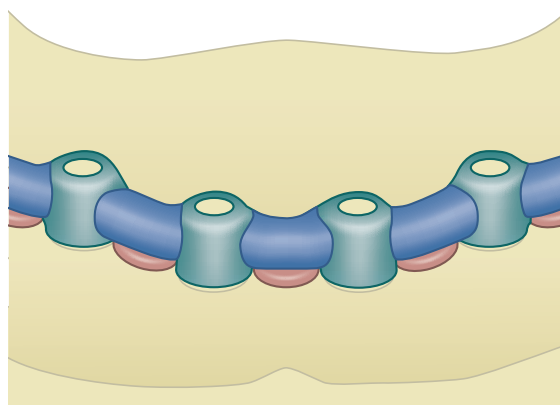
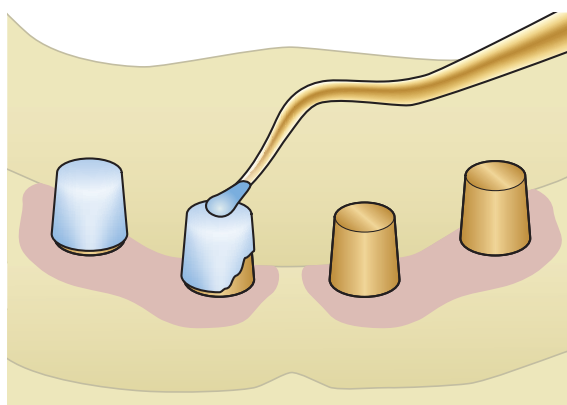

Attaching Ankylos tapered caps for SynCone

Place the Degulor tapered caps without retention on the abutments and cover with a 0.2 mm thick layer of wax as a placeholder.

When using tapered caps with retention, the retention section of the caps should be ground off beforehand. All undercut sections should be blocked for preparation of the duplicate model for making the cast.

Wax-up of metal framework

The metal reinforcement, represented in the illustration as an internal reinforcement, is waxed up on the investment model. A wax-up with matrix ensures the correct position of the metal framework, a rear cover plate can be fabricated as an option.

Ensure that the connections between the cap mountings and the retentions are stable. The framework must have a clearance of 1–2 mm to the basal mucosa and should be shorter than the caps.

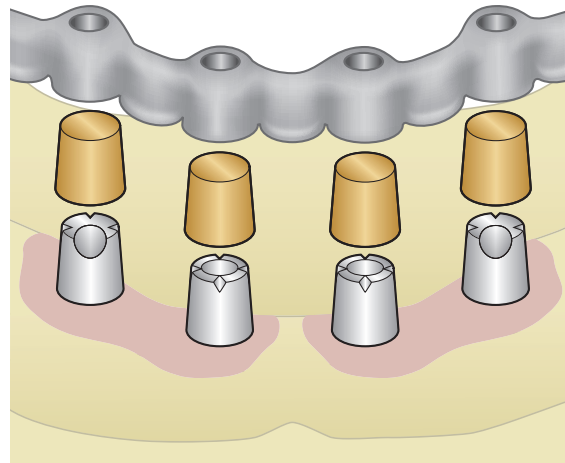
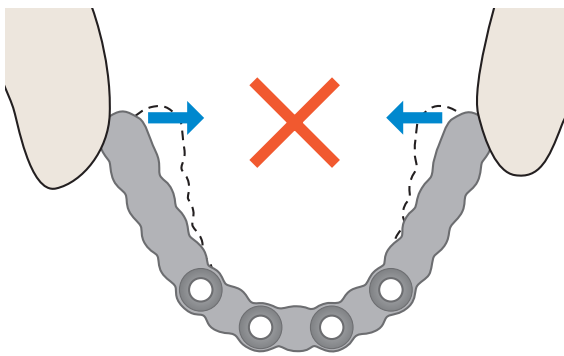

Finishing the framework

After casting, devest and finish the framework. Small windows for checking the fit of the caps are placed in the occlusal edge of the caps. These allow the adhesive to escape easier during later bonding in the mouth.

Check of stability and fit

The stability of the metal framework is checked by applying pressure on both sides of the saddles. These should not bend under pressure. The finished metal reinforcement in the model is checked for a contact-free fit on the caps. To this purpose, the caps are placed gently on the stumps and must not come off when the framework is removed.

The metal framework is bonded to the tapered caps directly in the patient's mouth to provide an optimal, tension-free prosthetic fit (passive fit). To this end, the dental laboratory will make the following preparations.

Preparations for intraoral bonding

The exterior of the tapered caps is roughened by abrasive blasting with aluminum oxide in preparation for intraoral bonding. The caps and the framework are sent to the dental surgeon.

If the Ankylos SynCone abutments are selected in the dental laboratory, remove these from the model using the transfer key and also send them to the dental practice.

Step-by-step: Intraoral bonding

To provide a tension-free fit of the prosthesis (passive fit), the prosthetic framework fabricated by the dental laboratory is bonded intraorally to the SynCone caps. As part of this two-stage procedure, the Ankylos SynCone abutments are inserted first in the patient's mouth. This first procedure is omitted following immediate restoration, as the patient already wears

a prosthesis fixed on SynCone abutments. Bonding of the components directly in the patient's mouth ensures maximum precision and thus the fit necessary for the prosthesis when using the taper technique. Bonding by the dental laboratory will lead to failure.

After immediate loading

After submerged healing

After submerged healing

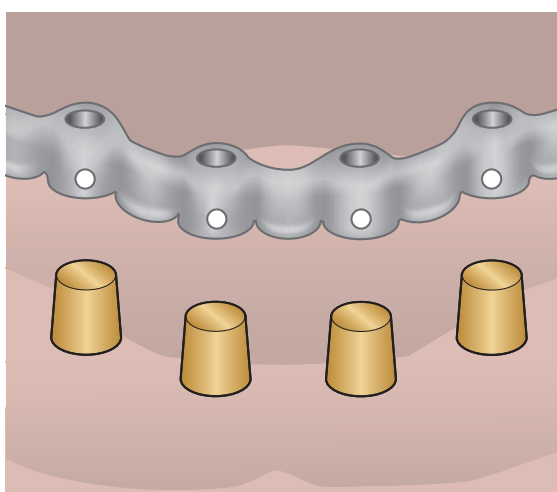
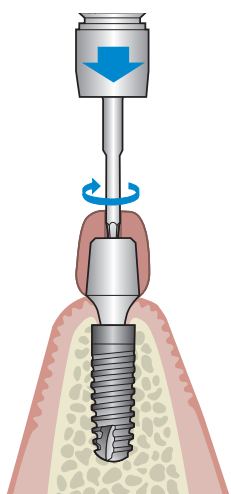

Screwing in of Ankylos SynCone C/ abutments

Ensure that the inner taper of the implant has been thoroughly rinsed and dried prior to incorporating the SynCone C/ abutments selected in the dental laboratory. The SynCone C/ abutments should be sterilized prior to incorporation.

The abutments are then screwed into the implants with the 1.0 mm hexagon screwdriver with the aid of the transfer key prepared in the dental laboratory. The torque-wrench with hex insert or a torque-controlled contra-angle handpiece serve this purpose. The recommended torque for the straining screw is 15 Ncm.

Preparing SynCone caps for bonding

Place the caps on the abutments applying firm pressure. The outer surfaces of the caps were roughened in the dental laboratory by abrasive blasting with aluminum oxide in preparation for bonding, and are cleaned again with alcohol immediately prior to bonding.

Preparing the framework for bonding

The framework is to be checked for a movement- and tension-free fit as well as for clearance from the basal mucosa. The framework in the cap area should be shorter than the cap margins.

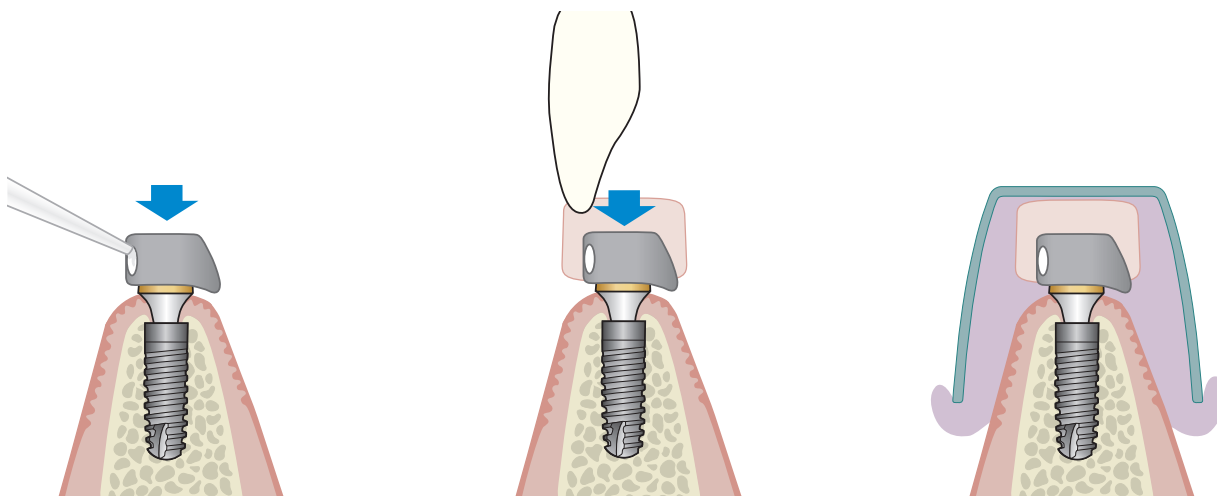

Bonding framework to caps

Coat the framework with metal adhesive for intraoral use, press onto the caps as for cementing a bridge and allow the adhesive to cure.

Remove excess adhesive prior to hardening, particularly in the undercut areas. Remove the framework with the caps and remove any excess adhesive.

After bonding, the framework must not rock and should fit tension-free (passive fit). The procedure should be repeated if this is not the case.

Bite registration

The framework is fitted with a synthetic wall after bonding and the bite registration is taken.

Overall impression for fabricating the prosthesis

Following bite registration, an unpressurized impression is taken by coating the framework. It is imperative that a plastic tray is used for this process. The impression is sent to the dental laboratory where the metal reinforced prosthesis is then completed.

If an existing prosthesis is worn as a temporary denture during this period, this should be ground out, if necessary, in the region of the abutments now remaining in the patient's mouth and adjusted to the changed situation with non-hardening lining material (not in the case of preceding immediate loading).

Step-by-step: Finishing and delivery of the prosthesis

After intraoral bonding of the tapered caps and the metal framework, the dentist is to perform a bite registration and produce an overall impression for transferring the framework position in the patient's mouth. Both are sent to the dental laboratory together with the metal framework bonded to the caps.

The SynCone abutments always remain in the patient's mouth. The existing prosthesis should be ground out in the area of the abutments now remaining in the patient's mouth and adapted to the altered situation using non-hardening relining material.

After immediate loading

After submerged healing

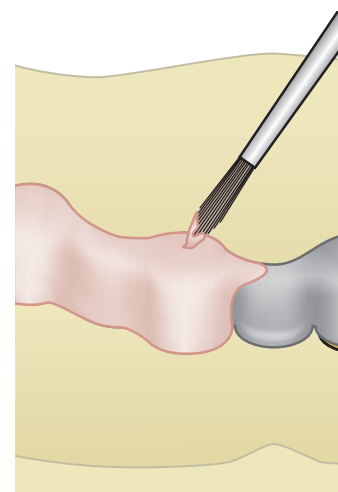
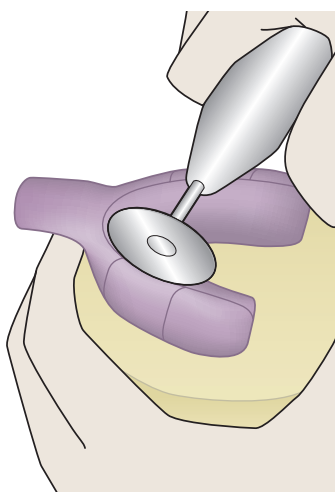
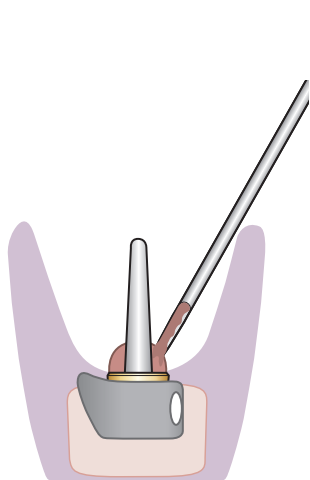

Casting the model

The dental laboratory creates a model from the overall impression sent by the dental practice, showing the exact position of the intraorally bonded metal framework in the patient's mouth. To fabricate the model, first insulate the Ankylos SynCone caps, fill these with self-curing liquid plastic and provide with a dowel pin. Then fill the impression with dental stone.

Dividing the tray

The tray must not be removed as usual after the stone has hardened, as this may cause the framework to bend. Instead, the synthetic tray is divided into segments and the impression is removed from the model and framework in sections.

Opaquing the framework

Pink opaquer is applied to the framework to complete the prosthesis.

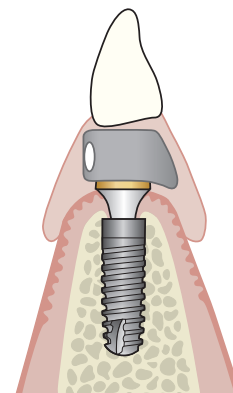
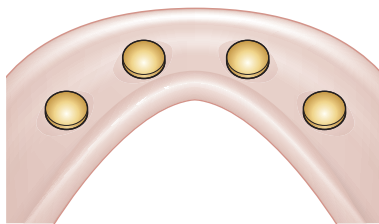
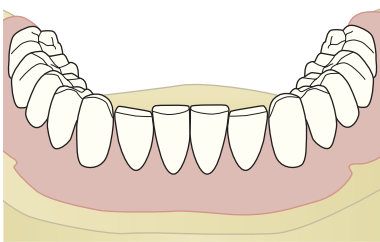

Completing the prosthesis

Position the teeth and after fitting, finish the prosthesis with cold-cure resin. The prosthesis cannot be finished with hot-curing resin due to temperature development and the changes in position of the caps this may cause.

After completion, inspect the interior of the caps for any excess synthetic sprue. This is removed if present.

Since the prosthesis is now mounted purely on implants, the margins of the prosthesis are shortened as far as possible.

The prosthesis can be designed similar to a bridge as there is no longer any soft tissue support. However, all margins need to be sealed. A maxillary prosthesis can be designed without a palate.

The finished prosthesis is sent to the dental practice for delivery on the Ankylos SynCone abutments already located in the patient's mouth.

Delivery of the prosthesis

The prosthesis is delivered according to the principles of full dentures. Any premature contacts should be corrected.

The patient should be instructed on how to remove and reinsert the denture, and which hygiene measures are to be observed.

System components

Components and instruments

The abutments for the Ankylos SynCone treatment concept are only available with non-indexed tapered connection geometry, as free positioning of the abutments is essential.

All Ankylos SynCone C/ components are laser-marked with a „C/“ as in „C“onus according to their possible use.



Diameters, angulations and head heights Gingival heights

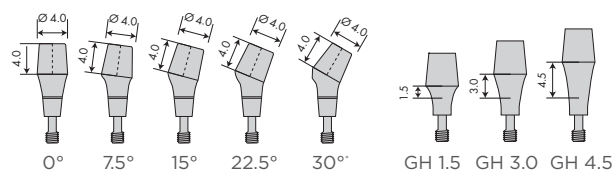

Ankylos SynCone C/ abutment 5°, straight and angled, cover screw for straight abutment

Dimensions Ankylos SynCone C/ abutment [mm]

Prosthetic restoration

Ankylos SynCone C/ Abutment

- For the restoration of the edentulous mandible with an immediate or delayed loaded prosthesis on four prefabricated interforaminal tapered abutments
- For the restoration of the edentulous maxilla on six osseointegrated implants
- Abutments with 5° tapered angle, adaptable to the clinical situation via three gingival heights (1.5/3.0/4.5 mm) and five angulations (0°, 7.5°, 15°, 22.5° and 30°).
- Cover screw for straight 5° abutments must be ordered separately



Polymerization sleeve for Ankylos SynCone, tapered caps for Ankylos SynCone with and without retention

Ankylos Tapered Cap Degulor for SynCone

- Caps with retention for secure attachment of an existing prosthesis to SynCone abutments
- Caps without retention for bonding to the metal base of a newly fabricated prosthesis
- Alloy with high gold content Degulor 3406

Polymerization Sleeve for Ankylos SynCone

- Prevents the polymerizate from entering the peri-implant sulcus region during polymerization of the caps into an existing prosthesis chairside



System components



Ankylos Balance C/
implant analogs



Ankylos parallelization gauge



Ankylos laboratory screwdriver 1.0 mm hex
(left) and positioning key for angled Stan-
dard abutments

Casting the model

Ankylos Balance C/ Implant Analog

- For fixation of the prosthetic components in the master cast
- Surgical steel

Instruments

Parallelization Gauge for Ankylos SynCone

- For the parallel axial alignment of the SynCone abutments
- Available for all tapered angles
- Connection for positioning key for SynCone 5°

Ankylos Laboratory Screwdriver 1.0 mm hex

- Reduced torque 10 Ncm
- Prevents excessive turning of straining screw

Ankylos Positioning Key for Angled Standard Abutments

- To facilitate rotation of the angled abutments via the parallelization gauges as part of the parallel alignment of the abutments
- Included in the prosthetic kit

Ankylos SynCone® C/: Products

Gingival height 1.5



Scale 1.2:1



Angulation A 0 A 7.5 A 15 A 22.5 A 30

Order no.	3102 2110	3102 2112	3102 2114	3102 2116	3102 2118
-----------	-----------	-----------	-----------	-----------	-----------

Gingival height 3.0



Scale 1.2:1



Angulation A 0 A 7.5 A 15 A 22.5 A 30

Order no.	3102 2120	3102 2122	3102 2124	3102 2126	3102 2128
-----------	-----------	-----------	-----------	-----------	-----------

Gingival height 4.5



Scale 1.2:1



Angulation A 0 A 7.5 A 15 A 22.5 A 30

Order no.	3102 2130	3102 2132	3102 2134	3102 2136	3102 2138
-----------	-----------	-----------	-----------	-----------	-----------

**Ankylos Cover Screw
for SynCone C/ Abutment
straight 5°**

**Ankylos Taper Cap Degulor
for SynCone® 5°**

**Ankylos Drilling
Sleeve for
SynCone (titanium)**

Scale 1.2:1



with retention without retention

Order no.	3105 6280	3102 2198	3102 2199	3104 5490
-----------	-----------	-----------	-----------	-----------

**Ankylos
Parallel Gauge
for SynCone**

**Ankylos
Polymerization
Sleeve for
SynCone**

Scale 1.2:1



Order no.	3103 3611	3102 1405
-----------	-----------	-----------



About Dentsply Sirona Implants

Dentsply Sirona Implants offers comprehensive solutions for all phases of implant therapy, including Ankylos®, Astra Tech Implant System® and Xive® implant lines, digital technologies, such as Atlantis® patient-specific solutions and Simplant® guided surgery, Symbios® regenerative solutions, and professional and business development programs, such as STEPPS™. Dentsply Sirona Implants creates value for dental professionals and allows for predictable and lasting implant treatment outcomes, resulting in enhanced quality of life for patients.

About Dentsply Sirona

Dentsply Sirona is the world's largest manufacturer of professional dental products and technologies, with a 130-year history of innovation and service to the dental industry and patients worldwide. Dentsply Sirona develops, manufactures, and markets a comprehensive solutions offering including dental and oral health products as well as other consumable medical devices under a strong portfolio of world class brands. As The Dental Solutions Company™, Dentsply Sirona's products provide innovative, high-quality and effective solutions to advance patient care and deliver better, safer and faster dentistry. Dentsply Sirona's global headquarters is located in York, Pennsylvania, and the international headquarters is based in Salzburg, Austria. The company's shares are listed in the United States on NASDAQ under the symbol XRAY.

Visit www.dentsplysirona.com for more information about Dentsply Sirona and its products.

THE DENTAL
SOLUTIONS
COMPANY™

