



DS Implants™

## Prosthetics product catalog

Astra Tech Implant System® EV

DS OmniTaper™

DS PrimeTaper®

All Dentsply Sirona Instructions for Use are available on [www.dentsplysirona.com/ifu](http://www.dentsplysirona.com/ifu)

All products may not be regulatory cleared/released/licensed in all markets. Please contact the local Dentsply Sirona sales office for current product assortment and availability.

To improve readability for our customers, Dentsply Sirona does not use ® or ™ in body copy. However, Dentsply Sirona does not waive any right to the trademark and nothing herein shall be interpreted to the contrary.

All trademarks and company names are the property of their respective owners.

Product illustrations are not to scale.

# CONTENTS

<b>1. Introduction</b> .....	4
Color coding .....	4
Implant-abutment connection .....	5
Prosthetic packaging .....	5
<b>2. Overviews</b> .....	6
<b>3. Cover screws</b> .....	16
<b>4. Healing abutments</b>	
HealDesign .....	16
Healing Abutment .....	18
<b>5. Temporary abutments</b>	
Temp Abutment .....	19
TempDesign .....	19
Abutment screws .....	20
TempBase Cap .....	20
<b>6. Impression and laboratory components</b>	
Implant Pick-Up Design .....	21
Implant Transfer .....	22
Scan components .....	23
Implant Analog .....	24
Lab Abutment Screw .....	24
<b>7. Cement-retained restorations</b>	
TiDesign .....	25
CastDesign .....	27
TitaniumBase .....	28
<b>8. Screw-retained restorations</b>	
MultiBase .....	29
<b>9. Attachment-retained restorations</b>	
LOCATOR R-Tx® .....	35
<b>10. Friction-retained restorations</b> .....	39
Conometric .....	39
<b>11. Restorative Instruments</b> .....	42
Prosthetic Tray .....	45

<b>Product catalog for Profile EV prosthetics</b>	
<b>12. Introduction</b> .....	47
Implant-abutment connection .....	47
<b>13. Overviews Profile EV</b> .....	48
<b>14. Cover screws</b> .....	52
<b>15. Healing abutments</b>	
HealDesign Profile .....	52
<b>16. Temporary abutments</b>	
Temp Abutment Profile .....	53
TempDesign Profile .....	53
Abutments screws .....	53
<b>17. Impression and laboratory components</b>	
Implant Pick-Up Design Profile .....	54
Implant Transfer Profile .....	54
Implant Replica Profile .....	54
Scan components .....	55
Lab Abutment Screw .....	56
<b>18. Cement-retained restorations</b>	
TiDesign Profile .....	56
<b>19. Screw-retained restorations</b>	
MultiBase .....	57
<b>20. Attachment-retained restorations</b>	
LOCATOR R-Tx® .....	57
<b>21. Appendix</b> .....	58
<b>22. Material specifications</b> .....	59
<b>23. Index</b> .....	60

# 1. Introduction

Throughout the prosthetic assortment you will find color-coding, markings and geometrical designs to simplify the correct identification of corresponding components.

Each implant-abutment connection size is identified by a specific color. The color is applied directly to components and instruments, as well as on packaging and informational material, where appropriate.

## Conversion and compatibility charts

Astra Tech Implant EV	Ø3.0 mm	Ø3.6 mm	Ø4.2 mm	Ø4.8 mm	Ø5.4 mm
Implant-abutment connection	<b>3.0</b>	<b>3.6</b>	<b>4.2</b>	<b>4.8</b>	<b>5.4</b>
	↕	↕	↕	↕	↕
EV connection	<b>XS</b>	<b>S</b>	<b>M</b>	<b>L</b>	<b>XL</b>

Xive / OmniTaper EV	Ø3.0 mm	Ø3.4 mm	Ø3.8 mm	Ø4.5 mm	Ø5.5 mm
Implant-abutment connection	<b>D 3.0</b>	<b>D 3.4</b>	<b>D 3.8</b>	<b>D 4.5</b>	<b>D 5.5</b>
	↓	↓	↓	↓	↓
EV connection	<b>XS</b>	<b>S</b>	<b>M</b>	<b>L</b>	<b>XL</b>

PrimeTaper EV	Ø3.0 mm	Ø3.6 mm	Ø4.2 mm	Ø4.8 mm	Ø5.4 mm
EV connection	<b>XS</b>	<b>S</b>	<b>M</b>	<b>L</b>	<b>L</b>

## Implant-abutment connection – EV connection

The implants have a unique interface providing three different options for abutment placement/indexing.

### Abutment placement/indexing options

#### One-position-only

Atlantis patient-specific abutments will only seat in one position.



#### Six positions

Indexed abutments will seat in six available positions.



#### Non-indexed

Non-indexed abutments will be seated in any rotational position.



## Prosthetic packaging



# XS Overview

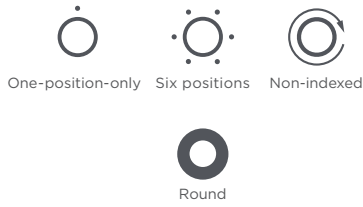

## Cover screw

Cover Screw EV



68010001

## Healing abutments

HealDesign EV



- Ø 3.5 2.5 mm 68013001
- Ø 3.5 3.5 mm 68013002
- Ø 3.5 4.5 mm 68013003
- Ø 3.5 6.5 mm 68013004

Healing Abutment EV



- Ø 4.0 2.0 mm 68013044
- Ø 4.0 3.0 mm 68013045
- Ø 4.0 4.0 mm 68013046
- Ø 4.0 6.0 mm 68013047

## Cement-retained

### Temporary abutments and components

TempAbutment EV\*



Ø 3.3 1 mm 68013064

TempDesign EV\*



Ø 6 5 mm 25503

TempBase Cap\*\*



Ø 3.0-3.8 68010013

### Abutments

TiDesign EV



- Ø 4.0 1.5 mm 68012001
- Ø 4.0 2.5 mm 68012002
- Ø 4.0 3.5 mm 68012003
- Ø 4.0 4.5 mm 68012004
- Ø 4.0 15° 1.5 mm 68012005
- Ø 4.0 15° 2.5 mm 68012006
- Ø 4.0 15° 3.5 mm 68012007
- Ø 4.0 15° 4.5 mm 68012008

\*Also for screw-retained single tooth restoration \*\* Only for pre-mounted TempBase on OmniTaper EV

## Screw-retained

### Abutments

MultiBase Abutment EV



- 1.5 mm 68012171
- 2.5 mm 68012172
- 3.5 mm 68012173

### Healing caps

MultiBase Heal Cap



Ø 5.4 - 4 mm  
68012230

### Impressions

MultiBase Pick-Up



68012232

MultiBase Transfer



68012231

**TitaniumBase EV\***



Ø 4.0 1 mm 68012081  
Ø 4.0 2 mm 68012082

**Implant impressions**

**Implant Pick-Up EV Design**



Long 68014013

**Implant Transfer EV**



Long 68014022

**Lab products**

**Lab Abutment Screw EV**



68014029

**Implant Analog EV**



68014034

**Lab products**

**MultiBase Lab Bridge Screw**



68012237

**MultiBase Analog**



68012238

**MultiBase Lab Abutment Pin**



14 mm 68012234  
18 mm 68012235  
22 mm 68012236

**Cylinders**

**MultiBase Temporary Cylinder**



68012239

**MultiBase Burnout Cylinder**



68012240

**MultiBase Semi-Burnout Cylinder**



68012243

**Bridge screws**

**MultiBase Bridge Screw**



68012233

# S Overview



One-position-only Six positions Non-indexed

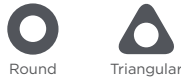

Round Triangular

## Cover screw

### Cover Screw EV



68010002

## Healing abutments

### HealDesign EV



- Ø 4.0 2.5 mm 68013005
- Ø 4.0 3.5 mm 68013006
- Ø 4.0 4.5 mm 68013007
- Ø 4.0 6.5 mm 68013008
- Ø 5.0 2.5 mm 68013009
- Ø 5.0 3.5 mm 68013010
- Ø 5.0 4.5 mm 68013011
- Ø 5.0 6.5 mm 68013012
- Ø 6.0 3.5 mm 68013013
- Ø 6.0 4.5 mm 68013014
- △ Ø 5.0 3.5 mm 68013039

### Healing Abutment EV



- Ø 4.0 2.0 mm 68013048
- Ø 4.0 3.0 mm 68013049
- Ø 4.0 4.0 mm 68013050
- Ø 4.0 6.0 mm 68013051

## Cement-retained

### Temporary abutments and components

#### TempAbutment EV\*



Ø 4.0 1 mm 68013066

#### TempDesign EV\*



Ø 7.5 mm 25504

#### TempBase Cap\*\*



Ø 3.0-3.8 68010013

### Abutments

#### TiDesign EV



- Ø 4.5 1.5 mm 68012009
- Ø 4.5 2.5 mm 68012010
- Ø 4.5 3.5 mm 68012011
- Ø 4.5 4.5 mm 68012012
- Ø 4.5 15° 1.5 mm 68012017
- Ø 4.5 15° 2.5 mm 68012018
- Ø 4.5 15° 3.5 mm 68012019
- Ø 4.5 15° 4.5 mm 68012020
- △ Ø 5.5 1.5 mm 68012025

## Screw-retained

### Abutments

#### MultiBase Abutment EV



- 1.5 mm 68012174
- 2.5 mm 68012175
- 3.5 mm 68012176
- 4.5 mm 68012177
- 17° 1.5 mm 68012178
- 17° 2.5 mm 68012179
- 17° 3.5 mm 68012180
- 17° 4.5 mm 68012181
- 17° 1.5 mm 68012182
- 17° 2.5 mm 68012183
- 17° 3.5 mm 68012184
- 17° 4.5 mm 68012185
- 30° 1.5 mm 68012186
- 30° 2.5 mm 68012187
- 30° 1.5 mm 68012190
- 30° 2.5 mm 68012191

### Healing caps

#### MultiBase Heal Cap



Ø 5.4 - 4 mm  
68012230

\* Also for screw-retained single tooth restoration  
\*\* Only for pre-mounted TempBase on OmniTaper EV

## Attachment-retained

### Abutments

#### LOCATOR R-Tx® Abutment EV



- 1 mm 68012414
- 2 mm 68012415
- 3 mm 68012416
- 4 mm 68012417
- 5 mm 68012418
- 6 mm 68012419

### Abutment impressions

#### LOCATOR R-Tx® Impression Coping



68012444

### Analog

#### LOCATOR R-Tx® Abutment Analog



68012443

## Friction-retained

### Abutments Conometric abutment

- Ø 3.3 0° 1 mm 26115
- Ø 3.3 0° 2 mm 26116
- Ø 3.3 0° 3 mm 26117
- Ø 4.5 0° 1 mm 26121
- Ø 4.5 0° 2 mm 26122
- Ø 4.5 0° 3 mm 26123
- Ø 4.5 15° 1 mm 26127
- Ø 4.5 15° 2 mm 26128
- Ø 4.5 15° 3 mm 26129















### Temporary components

#### Conometric Temporization cap









Ø3.3/4.6 31072112  
Ø4.5/5.8 31072114







<p><b>CastDesign EV*</b></p>  <p>Ø 4.1 1 mm 68012077</p> <p><b>TitaniumBase EV*</b></p>  <p>Ø 4.1 1 mm 68012083 Ø 4.1 2 mm 68012084</p>	<p align="center"><b>Implant impressions</b></p> <table border="0"> <tr> <td data-bbox="331 204 635 636"> <p align="center"><b>Implant Pick-Up EV Design</b></p>  <p>Short 68014009 Long 68014014</p> </td> <td data-bbox="635 204 906 636"> <p align="center"><b>Implant Transfer EV</b></p>  <p>Short 68014018 Long 68014023</p> </td> </tr> </table>	<p align="center"><b>Implant Pick-Up EV Design</b></p>  <p>Short 68014009 Long 68014014</p>	<p align="center"><b>Implant Transfer EV</b></p>  <p>Short 68014018 Long 68014023</p>	<p align="center"><b>Lab products</b></p> <table border="0"> <tr> <td data-bbox="906 204 1177 636"> <p align="center"><b>Lab Abutment Screw EV</b></p>  <p>68014030</p> </td> <td data-bbox="1177 204 1442 636"> <p align="center"><b>Implant Analog EV</b></p>  <p>68014035</p> </td> </tr> </table>	<p align="center"><b>Lab Abutment Screw EV</b></p>  <p>68014030</p>	<p align="center"><b>Implant Analog EV</b></p>  <p>68014035</p>
<p align="center"><b>Implant Pick-Up EV Design</b></p>  <p>Short 68014009 Long 68014014</p>	<p align="center"><b>Implant Transfer EV</b></p>  <p>Short 68014018 Long 68014023</p>					
<p align="center"><b>Lab Abutment Screw EV</b></p>  <p>68014030</p>	<p align="center"><b>Implant Analog EV</b></p>  <p>68014035</p>					

<p><b>Impressions</b></p> <p><b>MultiBase Pick-Up</b></p>  <p>68012232</p> <p><b>MultiBase Transfer</b></p>  <p>68012231</p>	<p align="center"><b>Lab products</b></p> <table border="0"> <tr> <td data-bbox="274 700 497 1195"> <p><b>MultiBase Lab Bridge Screw</b></p>  <p>68012237</p> <p><b>MultiBase Lab Abutment Pin</b></p>  <p>14 mm 68012234 18 mm 68012235 22 mm 68012236</p> </td> <td data-bbox="497 700 673 1195"> <p><b>MultiBase Analog</b></p>  <p>68012238</p> </td> </tr> </table>	<p><b>MultiBase Lab Bridge Screw</b></p>  <p>68012237</p> <p><b>MultiBase Lab Abutment Pin</b></p>  <p>14 mm 68012234 18 mm 68012235 22 mm 68012236</p>	<p><b>MultiBase Analog</b></p>  <p>68012238</p>	<p align="center"><b>Cylinders</b></p> <table border="0"> <tr> <td data-bbox="673 700 928 1195"> <p><b>MultiBase Temporary Cylinder</b></p>  <p>68012239</p> <p><b>MultiBase Semi-Burnout Cylinder</b></p>  <p>68012243</p> </td> <td data-bbox="928 700 1168 1195"> <p><b>MultiBase Burnout Cylinder</b></p>  <p>68012240</p> </td> </tr> </table>	<p><b>MultiBase Temporary Cylinder</b></p>  <p>68012239</p> <p><b>MultiBase Semi-Burnout Cylinder</b></p>  <p>68012243</p>	<p><b>MultiBase Burnout Cylinder</b></p>  <p>68012240</p>	<p align="center"><b>Bridge screws</b></p> <p><b>MultiBase Bridge Screw</b></p>  <p>68012233</p>
<p><b>MultiBase Lab Bridge Screw</b></p>  <p>68012237</p> <p><b>MultiBase Lab Abutment Pin</b></p>  <p>14 mm 68012234 18 mm 68012235 22 mm 68012236</p>	<p><b>MultiBase Analog</b></p>  <p>68012238</p>						
<p><b>MultiBase Temporary Cylinder</b></p>  <p>68012239</p> <p><b>MultiBase Semi-Burnout Cylinder</b></p>  <p>68012243</p>	<p><b>MultiBase Burnout Cylinder</b></p>  <p>68012240</p>						

**Attachment components**

<p><b>LOCATOR R-Tx® Mixed Retention Limited Range Processing Pack</b></p>  <p>68012439</p>	<p><b>LOCATOR R-Tx® Retention Insert Standard range</b></p>  <p>Grey 68012432    Pink 68012434 Blue 68012433    Clear 68012435</p>	<p><b>LOCATOR R-Tx® Retention Insert Limited range</b></p>  <p>Aqua 68012436 Magenta 68012437 Gold 68012438</p>	
<p><b>LOCATOR R-Tx® Processing Insert</b></p>  <p>68012440</p>	<p><b>LOCATOR R-Tx® Block-Out Spacer</b></p>  <p>68012441</p>	<p><b>LOCATOR R-Tx® Denture Attachment Processing Assembly</b></p>  <p>68012442</p>	<p><b>LOCATOR R-Tx® Processing Spacer</b></p>  <p>68012445</p>

<p align="center"><b>Healing cap</b></p> <p><b>Conometric Healing Cap</b></p>  <p>Ø3.3/4.8 31072101 Ø3.3/6.0 31072102 Ø4.5/6.0 31072103</p>	<p align="center"><b>Impressions</b></p> <p><b>Conometric Impression Cap</b></p>  <p>Ø3.3/5.4 31072001 Ø4.5/5.4 31072002</p>	<p align="center"><b>Lab components</b></p> <p><b>Conometric Analog</b></p>  <p>Ø3.3 31047210 Ø4.5 31072020</p>	<p><b>Conometric Lab Cap</b></p>  <p>Ø3.3/4.6 31072121 Ø4.5/5.8 31072123</p>	<p><b>Conometric Final Cap</b></p>  <p>Ø3.3/4.6 31072301 Ø4.5/5.8 31072303</p>
--	---	--	---	---

# M Overview

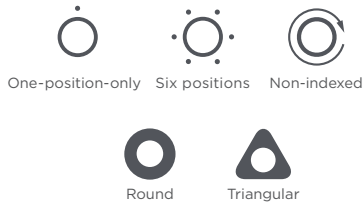

## Cover screw

### Cover Screw EV



68010005

## Healing abutments

### HealDesign EV



- Ø 5.0 2.5 mm 68013015
- Ø 5.0 3.5 mm 68013016
- Ø 5.0 4.5 mm 68013017
- Ø 5.0 6.5 mm 68013018
- Ø 6.5 2.5 mm 68013019
- Ø 6.5 3.5 mm 68013020
- Ø 6.5 4.5 mm 68013021
- Ø 6.5 6.5 mm 68013022
- △ Ø 5.0 3.5 mm 68013040
- △ Ø 6.5 3.5 mm 68013041

### Healing Abutment EV



- Ø 4.0 2.0 mm 68013052
- Ø 4.0 3.0 mm 68013053
- Ø 4.0 4.0 mm 68013054
- Ø 4.0 6.0 mm 68013055

## Cement-retained

### Temporary abutments and components

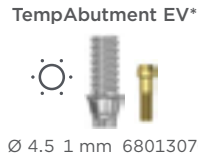

### TempBase Cap\*\*



### Abutments

#### TiDesign EV



- Ø 5.5 1.5 mm 68012042
- Ø 5.5 2.5 mm 68012043
- Ø 5.5 3.5 mm 68012044
- Ø 5.5 4.5 mm 68012045
- Ø 5.5 15° 1.5 mm 68012046
- Ø 5.5 15° 2.5 mm 68012047
- Ø 5.5 15° 3.5 mm 68012048
- Ø 5.5 15° 4.5 mm 68012049
- △ Ø 5.5 1.5 mm 68012050
- △ Ø 7.0 1.5 mm 68012051

## Screw-retained

### Abutments

#### MultiBase Abutment EV



- 1.5 mm 68012194
- 2.5 mm 68012195
- 3.5 mm 68012196
- 4.5 mm 68012197
- 30° 1.5 mm 68012206
- 30° 2.5 mm 68012207
- 30° 1.5 mm 68012208
- 30° 2.5 mm 68012209
- 17° 1.5 mm 68012198
- 17° 2.5 mm 68012199
- 17° 3.5 mm 68012200
- 17° 4.5 mm 68012201
- 17° 1.5 mm 68012202
- 17° 2.5 mm 68012203
- 17° 3.5 mm 68012204
- 17° 4.5 mm 68012205

### Healing caps

#### MultiBase Heal Cap



Ø 5.4 - 4 mm  
68012230

\* Also for screw-retained single tooth restoration  
\*\* Only for pre-mounted TempBase on OmniTaper EV

## Attachment-retained

### Abutments

#### LOCATOR R-Tx® Abutment EV



- 1 mm 68012420
- 2 mm 68012421
- 3 mm 68012422
- 4 mm 68012423
- 5 mm 68012424
- 6 mm 68012425

### Abutment impressions

#### LOCATOR R-Tx® Impression Coping



68012444

### Analog

#### LOCATOR R-Tx® Abutment Analog



68012443

## Friction-retained

### Abutments

#### Conometric abutment

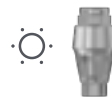



- Ø 4.5 0° 1 mm 26124
- Ø 4.5 0° 2 mm 26125
- Ø 4.5 0° 3 mm 26126
- Ø 4.5 15° 1 mm 26130
- Ø 4.5 15° 2 mm 26131
- Ø 4.5 15° 3 mm 26132

### Temporary components

#### Conometric Temporization cap















- Ø 3.3/4.6 31072112
- Ø 4.5/5.8 31072114

<p><b>CastDesign EV*</b></p>  <p>Ø 4.1 1 mm 68012078</p> <p><b>TitaniumBase EV*</b></p>  <p>Ø 4.7 1 mm 68012088 Ø 4.7 2 mm 68012089</p>	<p align="center"><b>Implant impressions</b></p> <table> <tr> <td data-bbox="351 255 606 489"> <p><b>Implant Pick-Up EV Design</b></p>  <p>Short 68014010 Long 68014015</p> </td> <td data-bbox="622 255 877 489"> <p><b>Implant Transfer EV</b></p>  <p>Short 68014019 Long 68014024</p> </td> </tr> </table>	<p><b>Implant Pick-Up EV Design</b></p>  <p>Short 68014010 Long 68014015</p>	<p><b>Implant Transfer EV</b></p>  <p>Short 68014019 Long 68014024</p>	<p align="center"><b>Lab products</b></p> <table> <tr> <td data-bbox="925 255 1165 425"> <p><b>Lab Abutment Screw EV</b></p>  <p>68014031</p> </td> <td data-bbox="1181 255 1420 425"> <p><b>Implant Analog EV</b></p>  <p>68014036</p> </td> </tr> </table>	<p><b>Lab Abutment Screw EV</b></p>  <p>68014031</p>	<p><b>Implant Analog EV</b></p>  <p>68014036</p>
<p><b>Implant Pick-Up EV Design</b></p>  <p>Short 68014010 Long 68014015</p>	<p><b>Implant Transfer EV</b></p>  <p>Short 68014019 Long 68014024</p>					
<p><b>Lab Abutment Screw EV</b></p>  <p>68014031</p>	<p><b>Implant Analog EV</b></p>  <p>68014036</p>					

<p><b>Impressions</b></p> <p><b>MultiBase Pick-Up</b></p>  <p>68012232</p> <p><b>MultiBase Transfer</b></p>  <p>68012231</p>	<p><b>Lab products</b></p> <table> <tr> <td data-bbox="319 744 494 893"> <p><b>MultiBase Lab Bridge Screw</b></p>  <p>68012237</p> </td> <td data-bbox="510 744 638 936"> <p><b>MultiBase Analog</b></p>  <p>68012238</p> </td> </tr> <tr> <td colspan="2" data-bbox="319 957 494 1170"> <p><b>MultiBase Lab Abutment Pin</b></p>  <p>14 mm 68012234 18 mm 68012235 22 mm 68012236</p> </td> </tr> </table>	<p><b>MultiBase Lab Bridge Screw</b></p>  <p>68012237</p>	<p><b>MultiBase Analog</b></p>  <p>68012238</p>	<p><b>MultiBase Lab Abutment Pin</b></p>  <p>14 mm 68012234 18 mm 68012235 22 mm 68012236</p>		<p><b>Cylinders</b></p> <table> <tr> <td data-bbox="702 744 909 936"> <p><b>MultiBase Temporary Cylinder</b></p>  <p>68012239</p> </td> <td data-bbox="925 744 1133 936"> <p><b>MultiBase Burnout Cylinder</b></p>  <p>68012240</p> </td> </tr> <tr> <td colspan="2" data-bbox="702 957 909 1170"> <p><b>MultiBase Semi-Burnout Cylinder</b></p>  <p>68012243</p> </td> </tr> </table>	<p><b>MultiBase Temporary Cylinder</b></p>  <p>68012239</p>	<p><b>MultiBase Burnout Cylinder</b></p>  <p>68012240</p>	<p><b>MultiBase Semi-Burnout Cylinder</b></p>  <p>68012243</p>		<p><b>Bridge screws</b></p> <p><b>MultiBase Bridge Screw</b></p>  <p>68012233</p>
<p><b>MultiBase Lab Bridge Screw</b></p>  <p>68012237</p>	<p><b>MultiBase Analog</b></p>  <p>68012238</p>										
<p><b>MultiBase Lab Abutment Pin</b></p>  <p>14 mm 68012234 18 mm 68012235 22 mm 68012236</p>											
<p><b>MultiBase Temporary Cylinder</b></p>  <p>68012239</p>	<p><b>MultiBase Burnout Cylinder</b></p>  <p>68012240</p>										
<p><b>MultiBase Semi-Burnout Cylinder</b></p>  <p>68012243</p>											

**Attachment components**

<p><b>LOCATOR R-Tx* Mixed Retention Limited Range Processing Pack</b></p>  <p>68012439</p>	<p><b>LOCATOR R-Tx* Retention Insert Standard range</b></p>  <p>Grey 68012432    Pink 68012434 Blue 68012433    Clear 68012435</p>	<p><b>LOCATOR R-Tx* Retention Insert Limited range</b></p>  <p>Aqua 68012436 Magenta 68012437 Gold 68012438</p>	
<p><b>LOCATOR R-Tx* Processing Insert</b></p>  <p>68012440</p>	<p><b>LOCATOR R-Tx* Block-Out Spacer</b></p>  <p>68012441</p>	<p><b>LOCATOR R-Tx* Denture Attachment Processing Assembly</b></p>  <p>68012442</p>	<p><b>LOCATOR R-Tx* Processing Spacer</b></p>  <p>68012445</p>

<p><b>Healing cap</b></p> <p><b>Conometric Healing Cap</b></p>  <p>Ø3.3/4.8 31072101 Ø3.3/6.0 31072102 Ø4.5/6.0 31072103</p>	<p><b>Impressions</b></p> <p><b>Conometric Impression Cap</b></p>  <p>Ø3.3/5.4 31072001 Ø4.5/5.4 31072002</p>	<p><b>Conometric Analog</b></p>  <p>Ø3.3 31047210 Ø4.5 31072020</p>	<p><b>Lab components</b></p> <p><b>Conometric Lab Cap</b></p>  <p>Ø3.3/4.6 31072121 Ø4.5/5.8 31072123</p>	<p><b>Conometric Final Cap</b></p>  <p>Ø3.3/4.6 31072301 Ø4.5/5.8 31072303</p>
---	--	--	--	---

# L Overview

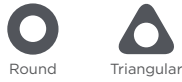

## Cover screw

Cover Screw EV



68010006

## Healing abutments

HealDesign EV



	●	Ø 5.0	2.5 mm	68013023
	●	Ø 5.0	3.5 mm	68013024
	●	Ø 5.0	4.5 mm	68013025
	●	Ø 5.0	6.5 mm	68013026
	●	Ø 6.5	2.5 mm	68013027
	●	Ø 6.5	3.5 mm	68013028
	●	Ø 6.5	4.5 mm	68013029
	●	Ø 6.5	6.5 mm	68013030
	●	Ø 7.5	3.5 mm	68013031
	●	Ø 7.5	4.5 mm	68013032
	▲	Ø 5.0	3.5 mm	68013042
	▲	Ø 6.5	3.5 mm	68013043

Healing Abutment EV



	●	Ø 4.3	2.0 mm	68013056
	●	Ø 4.3	3.0 mm	68013057
	●	Ø 4.3	4.0 mm	68013058
	●	Ø 4.3	6.0 mm	68013059

## Cement-retained

### Temporary abutments and components

TempAbutment EV\*



Ø 5 1 mm 68013072

TempDesign EV\*



Ø 10 5 mm 25506

TempBase Cap\*\*



Ø 4.5 68010014

### Abutments

TiDesign EV



●	Ø 7.0	1.5 mm	68012052
●	Ø 7.0	2.5 mm	68012053
●	Ø 7.0	3.5 mm	68012054
●	Ø 7.0	4.5 mm	68012055
●	Ø 5.5 15°	1.5 mm	68012056
●	Ø 5.5 15°	2.5 mm	68012057
●	Ø 5.5 15°	3.5 mm	68012058
●	Ø 5.5 15°	4.5 mm	68012059
▲	Ø 5.5	1.5 mm	68012060
▲	Ø 7.0	1.5 mm	68012061

\*Also for screw-retained single tooth restoration \*\* Only for pre-mounted TempBase on OmniTaper EV

## Screw-retained

### Abutments

MultiBase Abutment EV



	1.5 mm	68012210		30° 1.5 mm	68012221
	2.5 mm	68012211		30° 2.5 mm	68012222
	3.5 mm	68012212		30° 1.5 mm	68012223
	4.5 mm	68012213		30° 2.5 mm	68012224
	17° 1.5 mm	68012214			
	17° 2.5 mm	68012215			
	17° 3.5 mm	68012216			
	17° 4.5 mm	68012217			
	17° 1.5 mm	68012218			
	17° 2.5 mm	68012219			
	17° 3.5 mm	68012220			
	17° 4.5 mm	68012352			

### Healing caps

MultiBase Heal Cap



Ø 5.4 - 4 mm  
68012230

## Attachment-retained

### Abutments

LOCATOR R-Tx® Abutment EV



	1 mm	68012426
	2 mm	68012427
	3 mm	68012428
	4 mm	68012429
	5 mm	68012430
	6 mm	68012431

### Abutment impressions

LOCATOR R-Tx®  
Impression Coping

















68012444





















### Analog

LOCATOR R-Tx®  
Abutment Analog









68012443

<p><b>CastDesign EV*</b></p>  <p>Ø 5.1 1 mm 68012079</p> <p><b>TitaniumBase EV*</b></p>  <p>Ø 5.0 1 mm 68012090 Ø 5.0 2 mm 68012091</p>	<p align="center"><b>Implant impressions</b></p> <table border="0"> <tr> <td data-bbox="351 255 606 510"> <p><b>Implant Pick-Up EV Design</b></p>  <p>Short 68014011 Long 68014016</p> </td> <td data-bbox="622 255 877 510"> <p><b>Implant Transfer EV</b></p>  <p>Short 68014020 Long 68014025</p> </td> </tr> </table>	<p><b>Implant Pick-Up EV Design</b></p>  <p>Short 68014011 Long 68014016</p>	<p><b>Implant Transfer EV</b></p>  <p>Short 68014020 Long 68014025</p>	<p align="center"><b>Lab products</b></p> <table border="0"> <tr> <td data-bbox="925 255 1181 446"> <p><b>Lab Abutment Screw EV</b></p>  <p>68014032</p> </td> <td data-bbox="1197 255 1436 446"> <p><b>Implant Analog EV</b></p>  <p>68014037</p> </td> </tr> </table>	<p><b>Lab Abutment Screw EV</b></p>  <p>68014032</p>	<p><b>Implant Analog EV</b></p>  <p>68014037</p>
<p><b>Implant Pick-Up EV Design</b></p>  <p>Short 68014011 Long 68014016</p>	<p><b>Implant Transfer EV</b></p>  <p>Short 68014020 Long 68014025</p>					
<p><b>Lab Abutment Screw EV</b></p>  <p>68014032</p>	<p><b>Implant Analog EV</b></p>  <p>68014037</p>					

<p><b>Impressions</b></p> <p><b>MultiBase Pick-Up</b></p>  <p>68012232</p> <p><b>MultiBase Transfer</b></p>  <p>68012231</p>	<p><b>Lab products</b></p> <table border="0"> <tr> <td data-bbox="303 872 494 1064"> <p><b>MultiBase Lab Bridge Screw</b></p>  <p>68012237</p> </td> <td data-bbox="510 872 638 1064"> <p><b>MultiBase Analog</b></p>  <p>68012238</p> </td> </tr> <tr> <td colspan="2" data-bbox="303 1085 638 1361"> <p><b>MultiBase Lab Abutment Pin</b></p>  <p>14 mm 68012234 18 mm 68012235 22 mm 68012236</p> </td> </tr> </table>	<p><b>MultiBase Lab Bridge Screw</b></p>  <p>68012237</p>	<p><b>MultiBase Analog</b></p>  <p>68012238</p>	<p><b>MultiBase Lab Abutment Pin</b></p>  <p>14 mm 68012234 18 mm 68012235 22 mm 68012236</p>		<p><b>Cylinders</b></p> <table border="0"> <tr> <td data-bbox="694 872 925 1064"> <p><b>MultiBase Temporary Cylinder</b></p>  <p>68012239</p> </td> <td data-bbox="941 872 1133 1064"> <p><b>MultiBase Burnout Cylinder</b></p>  <p>68012240</p> </td> </tr> <tr> <td colspan="2" data-bbox="694 1085 1133 1361"> <p><b>MultiBase Semi-Burnout Cylinder</b></p>  <p>68012243</p> </td> </tr> </table>	<p><b>MultiBase Temporary Cylinder</b></p>  <p>68012239</p>	<p><b>MultiBase Burnout Cylinder</b></p>  <p>68012240</p>	<p><b>MultiBase Semi-Burnout Cylinder</b></p>  <p>68012243</p>		<p><b>Bridge screws</b></p> <p><b>MultiBase Bridge Screw</b></p>  <p>68012233</p>
<p><b>MultiBase Lab Bridge Screw</b></p>  <p>68012237</p>	<p><b>MultiBase Analog</b></p>  <p>68012238</p>										
<p><b>MultiBase Lab Abutment Pin</b></p>  <p>14 mm 68012234 18 mm 68012235 22 mm 68012236</p>											
<p><b>MultiBase Temporary Cylinder</b></p>  <p>68012239</p>	<p><b>MultiBase Burnout Cylinder</b></p>  <p>68012240</p>										
<p><b>MultiBase Semi-Burnout Cylinder</b></p>  <p>68012243</p>											

**Attachment components**

<p><b>LOCATOR R-Tx® Mixed Retention Limited Range Processing Pack</b></p>  <p>68012439</p>	<p><b>LOCATOR R-Tx® Retention Insert Standard range</b></p>  <p>Grey 68012432 Blue 68012433 Pink 68012434 Clear 68012435</p>	<p><b>LOCATOR R-Tx® Retention Insert Limited range</b></p>  <p>Aqua 68012436 Magenta 68012437 Gold 68012438</p>	
<p><b>LOCATOR R-Tx® Processing Insert</b></p>  <p>68012440</p>	<p><b>LOCATOR R-Tx® Block-Out Spacer</b></p>  <p>68012441</p>	<p><b>LOCATOR R-Tx® Denture Attachment Processing Assembly</b></p>  <p>68012442</p>	<p><b>LOCATOR R-Tx® Processing Spacer</b></p>  <p>68012445</p>

# XL Overview

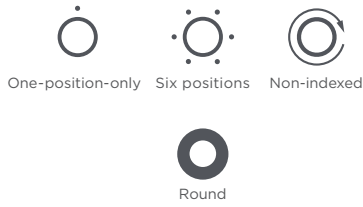

## Cover screw

Cover Screw EV



68010007

## Healing abutments

HealDesign EV



- Ø 6.5 2.5 mm 68013033
- Ø 6.5 3.5 mm 68013034
- Ø 6.5 4.5 mm 68013035
- Ø 6.5 6.5 mm 68013036
- Ø 7.5 3.5 mm 68013037
- Ø 7.5 4.5 mm 68013038

Healing Abutment EV



- Ø 4.8 2.0 mm 68013060
- Ø 4.8 3.0 mm 68013061
- Ø 4.8 4.0 mm 68013062
- Ø 4.8 6.0 mm 68013063

## Cement-retained

### Temporary abutments and components

TempAbutment EV\*



Ø 5.5 1 mm 68013074

TempDesign EV\*



Ø 10 5 mm 25507

TempBase Cap\*\*



Ø 5.5 68010015

### Abutments

TiDesign EV



- Ø 7.0 1.5 mm 68012062
- Ø 7.0 2.5 mm 68012063
- Ø 7.0 15° 1.5 mm 68012064
- Ø 7.0 15° 2.5 mm 68012065

\*Also for screw-retained single tooth restoration \*\* Only for pre-mounted TempBase on OmniTaper EV

## Screw-retained

### Abutments

MultiBase Abutment EV



- 1.5 mm 68012225
- 2.5 mm 68012226
- 3.5 mm 68012227
- 4.5 mm 68012228

### Healing caps

MultiBase Heal Cap



Ø 5.4 - 4 mm  
68012230

### Impressions

MultiBase Pick-Up



68012232

MultiBase Transfer



68012231

XL is not applicable for PrimeTaper EV

**CastDesign EV\***



Ø 5.1 1 mm 68012080

**TitaniumBase EV\***



Ø 5.5 1 mm 68012092  
Ø 5.5 2 mm 68012093

**Implant impressions**

**Implant Pick-Up EV Design**



Short 68014012  
Long 68014017

**Implant Transfer EV**



Short 68014021  
Long 68014026

**Lab products**

**Lab Abutment Screw EV**



68014033

**Implant Analog EV**



68014038

**Lab products**

**MultiBase Lab Bridge Screw**



68012237

**MultiBase Analog**



68012238

**MultiBase Lab Abutment Pin**



14 mm 68012234  
18 mm 68012235  
22 mm 68012236

**Cylinders**

**MultiBase Temporary Cylinder**



68012239

**MultiBase Burnout Cylinder**



68012240

**MultiBase Semi-Burnout Cylinder**



68012243

**Bridge screws**

**MultiBase Bridge Screw**



68012233

### 3. Cover screw

#### Cover Screw EV

Titanium alloy<sup>1</sup>, sterile

The Cover Screw is used for sealing the implant interface.

- Clinical use: two-stage surgical procedures
- Color coded

#### Cover Screw EV



\* Not applicable for PrimeTaper EV

### 4. Healing abutments

#### HealDesign EV

Titanium alloy<sup>1</sup>, sterile

The HealDesign is used for soft tissue sculpturing during the healing phase.

- The design of the healing abutments is based upon the natural dentition utilizing a site-specific, crown-down approach.
- The design mimics a variety of tooth shapes and support the soft tissue, preparing for the final abutment.
- Heights and diameters are harmonized with the final abutments and with the expected tooth positions.
- Clinical use: one- and two-stage surgery
- Color coded
- Indexing options; six-position and non-indexed

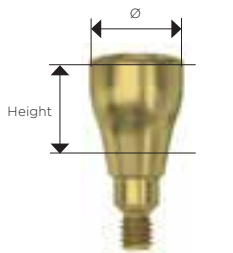

Round shapes are indicated for all positions in the mouth.

Triangular shapes are designed for anterior implant sites and mimics the specific shape for incisors and canines. Triangular HealDesign EV is a two-piece abutment.

#### XS HealDesign EV



#### S HealDesign EV





**M** HealDesign EV



Ø mm	5	5	5	5
Height mm	2.5	3.5	4.5	6.5
Order No.	68013015	68013016	68013017	68013018



Ø mm	6.5	6.5	6.5	6.5	5	6.5
Height mm	2.5	3.5	4.5	6.5	3.5	3.5
Order No.	68013019	68013020	68013021	68013022	68013040	68013041

**L** HealDesign EV

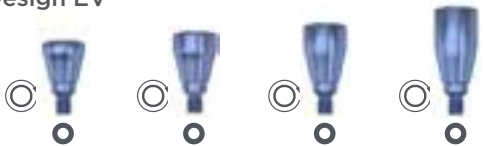

Ø mm	5	5	5	5
Height mm	2.5	3.5	4.5	6.5
Order No.	68013023	68013024	68013025	68013026



Ø mm	6.5	6.5	6.5	6.5	7.5	7.5	5	6.5
Height mm	2.5	3.5	4.5	6.5	3.5	4.5	3.5	3.5
Order No.	68013027	68013028	68013029	68013030	68013031	68013032	68013042	68013043

**XL** HealDesign EV\*



Ø mm	6.5	6.5	6.5	6.5	7.5	7.5
Height mm	2.5	3.5	4.5	6.5	3.5	4.5
Order No.	68013033	68013034	68013035	68013036	68013037	68013038

\* Not applicable for PrimeTaper EV

### Healing Abutment EV

Titanium alloy<sup>1</sup>, sterile

The healing abutment is used for soft tissue sculpturing.

- Height markings
- Color coded
- Indexing option; non-indexed

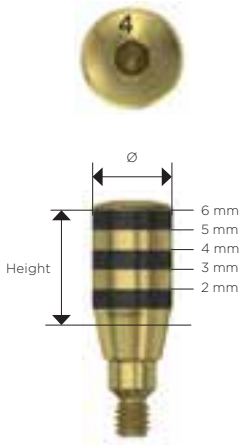

### XS Healing Abutment EV

Ø mm	4	4	4	4
Height mm	2	3	4	6
Order No.	68013044	68013045	68013046	68013047

### S Healing Abutment EV

Ø mm	4	4	4	4
Height mm	2	3	4	6
Order No.	68013048	68013049	68013050	68013051

### M Healing Abutment EV

Ø mm	4	4	4	4
Height mm	2	3	4	6
Order No.	68013052	68013053	68013054	68013055

### L Healing Abutment EV

Ø mm	4.3	4.3	4.3	4.3
Height mm	2	3	4	6
Order No.	68013056	68013057	68013058	68013059

### XL Healing Abutment EV\*

Ø mm	4.8	4.8	4.8	4.8
Height mm	2	3	4	6
Order No.	68013060	68013061	68013062	68013063

\* Not applicable for PrimeTaper EV

# 5. Temporary abutments

## TempAbutment EV

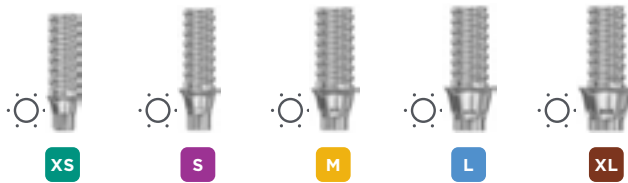

Ø mm	3.3	4.0	4.5	5.0	5.5
A - height mm	1	1	1	1	1
B - height mm	9	9	9	9	9
Order No.	68013064	68013066	68013070	68013072	68013074*

## TempAbutment EV

Titanium alloy<sup>1</sup>, non-sterile

The temporary abutment is used as a customizable base for temporary implant-level restorations and allows for further sculpturing of the soft tissue.

- Designed for build-up technique
- Primarily processed in the laboratory
- Restoration: screw- and cement-retained
- Screw-retained restorations, limited to single tooth only
- Clinical use: long-term temporization
- Contains: TempAbutment EV and corresponding color coded Abutment Screw EV
- Indexing option; six-positions

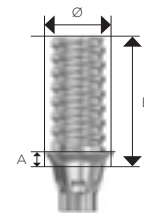

## TempDesign EV

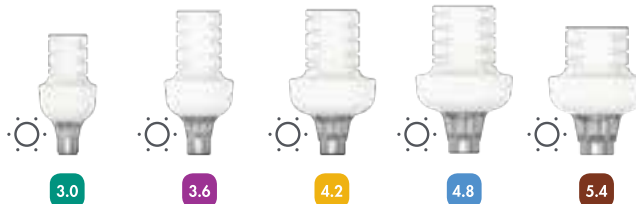

Ø mm	6	7	9	10	10
A - height mm	5	5	5	5	5
B - height mm	10	12	12	12	10
Order No.	25503	25504	25505	25506	25507*

## TempDesign EV

Titanium alloy<sup>1</sup> / PEEK plastic<sup>8</sup>, non-sterile

The TempDesign abutment is an abutment designed for reduction technique.

- Can be processed chairside or in the laboratory
- Restoration: screw- and cement-retained
- Screw-retained restorations limited to single-tooth only
- Clinical use: max 180 days
- Contains: TempDesign EV and corresponding color coded Abutment Screw EV
- Indexing option: six-positions

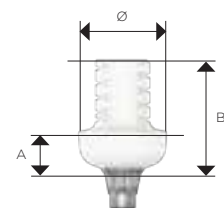

Astra Tech Implant System EV product assortment.  
See connection size conversion on page 4.

\* Not applicable for PrimeTaper EV

### Abutment Screw EV

Titanium alloy<sup>12</sup>, non-sterile

The abutment screw is used for securing the abutment to the implant.

- A corresponding abutment screw is included with every two-piece abutment.
- Additional screws can be ordered separately
- Color coded

### Abutment Screw EV

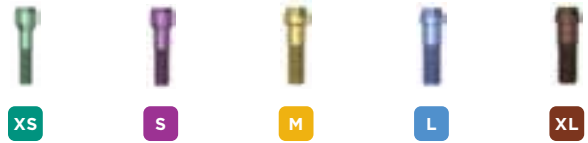

	M1.4	M1.6	M1.8	M2.0	M2.0
Order No.	68012166	68012167	68012168	68012169	68012170*

\* Not applicable for PrimeTaper EV

### TempBase Cap

PP plastic<sup>12</sup>, non-sterile

Transfer coping for index registration during surgery and basis for temporary restorations.

- Tooth-colored plastic
- Rotation lock
- Only for pre-mounted TempBase on OmniTaper EV
- Retention by a diamond-shaped head and a side retention tab

### TempBase Cap



Ø mm	3.0-3.8	4.5	5.5
Order No.	68010013	68010014	68010015

### Patient specific products - alternative restorative options



Atlantis Healing Abutment



Atlantis CustomBase Solution  
- Atlantis Abutment and  
Atlantis Temporary Crown

## 6. Impression and laboratory components

### Implant Pick-Up EV Design, Short



Ø mm		3.6	4.2	4.8	5.4
Height mm		16.7	16.7	16.7	16.7
Order No.		68014009	68014010	68014011	68014012*

### Implant Pick-Up EV Design

Titanium alloy<sup>3</sup>, non-sterile

The implant pick-up is used for transferring the implant position and the soft tissue anatomy to the master model.

- Self-guiding impression component
- Integrated pin for safe handling
- Designed with a hex at the pin head
- One-hand-procedure
- Designed for splinting possibilities
- Clinical use: open tray impression procedure
- Color coded
- Contains: Implant Pick-Up EV Design with pin
- Instruments needed: Hex Driver (optional)

### Implant Pick-Up EV Design, Long

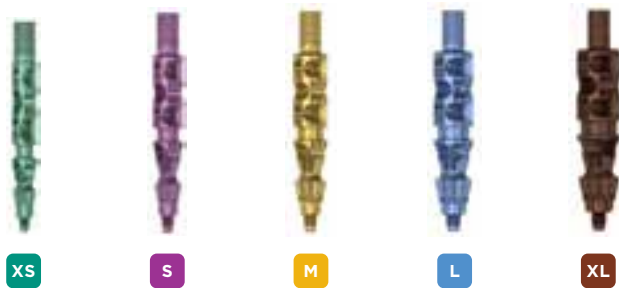

Ø mm	3.0	3.6	4.2	4.8	5.4
Height mm	22	22	22	22	22
Order No.	68014013	68014014	68014015	68014016	68014017*



\* Not applicable for PrimeTaper EV

### Implant Transfer EV

Titanium alloy<sup>3</sup>, non-sterile

The implant transfer is used for transferring the implant position and the soft tissue anatomy to the master model.

- Self-guiding impression component
- Integrated pin for safe handling
- One-hand procedure
- Designed with a hex at the pin head
- Clinical use: closed tray impression procedure
- Color coded
- Contains: Implant Transfer EV with pin
- Instruments needed: Hex Driver (optional)

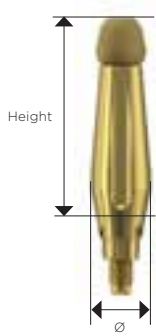

### Implant Transfer EV, Short

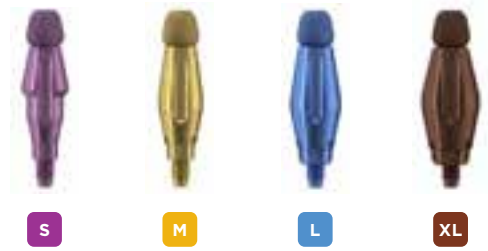

Ø mm		4.4	4.2	4.8	5.4
Height mm		11	11	11	11
Order No.		68014018	68014019	68014020	68014021*

### Implant Transfer EV, Long



Ø mm	4.0	4.4	4.2	4.8	5.4
Height mm	14	14	14	14	14
Order No.	68014022	68014023	68014024	68014025	68014026*

\* Not applicable for PrimeTaper EV

## Scan components

### Atlantis IO FLO

Intraoral scan



XS

S

M

L

XL

IO FLO code	IO P-01	IO P-02	IO P-03	IO P-04	IO P-05
Order No.	35243	35244	35245	35246	35247*

### Atlantis FLO

Lab scan



XS

S

M

L

XL

FLO code	P-01	P-02	P-03	P-04	P-05
Order No.	34593	34594	34595	34596	34597*

### Atlantis IO FLO

Titanium alloy<sup>1</sup> / PEEK plastic<sup>8</sup>, non-sterile

### Atlantis FLO

Stainless steel<sup>3</sup> / POM plastic<sup>7</sup>, non-sterile

Atlantis IO FLO is a scan body used for implant level digital impressions.

Atlantis FLO is a scan body used for implant level model scanning.

- Can be used with all connectivity when scanning for Atlantis abutments.
- Enables the design software to create a sufficient output to produce the restoration onto the TitaniumBase
- Instruments needed: Hex Driver for Atlantis IO FLO and Atlantis FLO screwdriver for Atlantis FLO.

A digital library is required when designing restorations for TitaniumBase. The digital library includes all necessary information of the implant system, TitaniumBase and scanbody. The libraries can be used for 3Shape and Exocad design software.

To download The TitaniumBase library, go to the help page for Dentsply Sirona Implants libraries at <https://www.orderdigitalsolutions.com/>

### Atlantis IO FLO-S

Implant level

XS

S

M

L

XL

FLO code	A04K	A04L	A04M	A04N	A04O
Order No.	68020018	68020019	68020020	68020021	68020022*

Abutment level



MultiBase Abutment EV	
FLO code	A04S
Order No.	68020034

### Atlantis IO FLO-S

Titanium<sup>2</sup>, non-sterile

The storage trays are made from aluminium with silicone grommets.

Atlantis IO FLO-S is a scan body used for implant or abutment level digital impressions.

- Atlantis IO FLO-S is used when scanning for Atlantis suprastructure.
- Can be used for both intraoral and model scanning.

The FLO-S scan body without the IO marking can only be used for model scanning and is not approved for intraoral scanning.

\* Not applicable for PrimeTaper EV

### Implant Analog EV

Titanium alloy<sup>3</sup>, non-sterile

The implant analog is used for laboratory fabrication of implant-level restorations.

- Single use
- Color coded

### Implant Analog EV



Height mm	13	13	13	13	13
Order No.	68014034	68014035	68014036	68014037	68014038*

### Lab Abutment Screw EV

Titanium alloy<sup>3</sup>, non-sterile

The lab abutment screw is used to secure the abutment on the implant analog.

- Designed for use with implant analog only
- Color coded
- Contains:  
4 pcs of Lab Abutment Screw EV

### Lab Abutment Screw EV

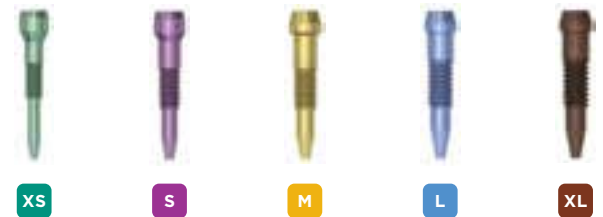

Order No.	68014029	68014030	68014031	68014032	68014033*
-----------	----------	----------	----------	----------	-----------

\* Not applicable for PrimeTaper EV



# 7. Cement-retained restorations

## XS TiDesign EV



Ø mm	4	4	4	4
A - height mm	1.5	2.5	3.5	4.5
B - height mm	2.5	3.5	4.5	5.5
C - height mm	7	8	9	10
Order No.	68012001	68012002	68012003	68012004



Ø mm	4	4	4	4
A - height mm	1.5	2.5	3.5	4.5
B - height mm	2.5	3.5	4.5	5.5
C - height mm	7	8	9	10
Order No.	68012005	68012006	68012007	68012008

## TiDesign EV

Titanium alloy<sup>3</sup>, non-sterile

TiDesign is used as a base for cement-retained restorations.

- Anatomically pre-designed abutment
- Round - design for the majority of tooth shapes
- Triangular - primarily for incisors and canines with distinct triangular shape
- Angled - for offset situations both in the anterior and posterior regions, compensating for implants with a restoratively unfavorable angulation
- Restoration: cement retained
- Clinical use: single and multi unit restorations
- Marked with connection size and diameter
- Color coded
- Contains: TiDesign EV abutment and corresponding Abutment Screw EV.
- Indexing option; six-positions

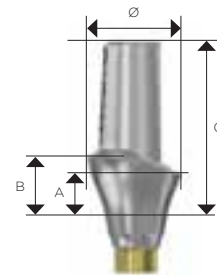

## S TiDesign EV

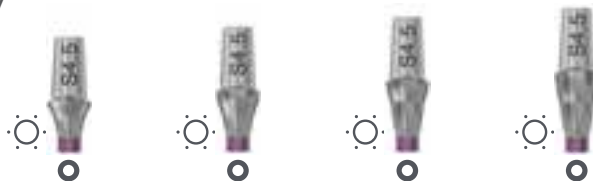

Ø mm	4.5	4.5	4.5	4.5
A - height mm	1.5	2.5	3.5	4.5
B - height mm	2.5	3.5	4.5	5.5
C - height mm	9	10	11	12
Order No.	68012009	68012010	68012011	68012012



Ø mm	4.5	4.5	4.5	4.5	5.5
A - height mm	1.5	2.5	3.5	4.5	1.5
B - height mm	2.5	3.5	4.5	5.5	2.5
C - height mm	9	10	11	12	9
Order No.	68012017	68012018	68012019	68012020	68012025

**M** TiDesign EV



Ø mm	5.5	5.5	5.5	5.5
A - height mm	1.5	2.5	3.5	4.5
B - height mm	2.5	3.5	4.5	5.5
C - height mm	9	10	11	12
Order No.	68012042	68012043	68012044	68012045



Ø mm	5.5	5.5	5.5	5.5	5.5	7.0
A - height mm	1.5	2.5	3.5	4.5	1.5	1.5
B - height mm	2.5	3.5	4.5	5.5	2.5	2.5
C - height mm	9	10	11	12	9	9
Order No.	68012046	68012047	68012048	68012049	68012050	68012051

**L** TiDesign EV



Ø mm	7.0	7.0	7.0	7.0
A - height mm	1.5	2.5	3.5	4.5
B - height mm	2.5	3.5	4.5	5.5
C - height mm	9	10	11	12
Order No.	68012052	68012053	68012054	68012055



Ø mm	5.5	5.5	5.5	5.5	5.5	7.0
A - height mm	1.5	2.5	3.5	4.5	1.5	1.5
B - height mm	2.5	3.5	4.5	5.5	2.5	2.5
C - height mm	9	10	11	12	9	9
Order No.	68012056	68012057	68012058	68012059	68012060	68012061

**XL TiDesign EV\***



Ø mm	7.0	7.0	7.0	7.0
A - height mm	1.5	2.5	1.5	2.5
B - height mm	2.5	3.5	2.5	3.5
C - height mm	9	10	9	10
Order No.	68012062	68012063	68012064	68012065

**CastDesign EV**



Ø mm	4.1	4.1	5.1	5.1
A - height mm	1	1	1	1
B - height mm	11	11	11	11
Order No.	68012077	68012078	68012079	68012080*

**CastDesign EV**

Gold-Platinum alloy<sup>2</sup> / POM plastic<sup>7</sup>, non-sterile

CastDesign is used for fabrication of a customized cement- or screw-retained restoration, using regular wax-up and cast-to techniques.

- Non-oxidizing high precious alloy abutment
- Modified at the laboratory
- Metal Base:  
Au 60%, Pd 20%, Pt 19%, Ir 1%
- Cylinder: POM burnout plastic
- Restoration: for screw-retained restorations, CastDesign is limited to single-tooth only
- Color coded
- Contains: CastDesign EV abutment and Abutment Screw EV
- Indexing option; six-positions

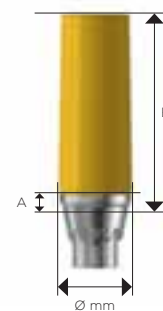

**Patient specific products - alternative restorative options**



Atlantis Abutment



Atlantis Crown Abutment



Atlantis CustomBase Solution - Atlantis Abutment and Atlantis Crown

\* Not applicable for PrimeTaper EV

### TitaniumBase EV

Titanium alloy<sup>1</sup>, non-sterile

TitaniumBase is used in the digital workflow as a base for customized ceramic restorations.

- Two flattened sides forming an anti-rotational feature
- Restoration: Cement-retained and screw-retained
- Clinical use: temporary or final restorations
- Screw-retained restorations are limited to single-tooth only
- Single and multi units
- Contains: TitaniumBase EV abutment and color coded Abutment Screw EV
- Instruments needed: Hex Driver and scanbody
- Indexing option; six-positions

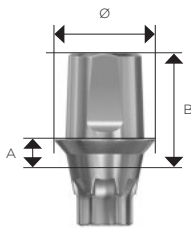

#### XS TitaniumBase EV



Ø mm	4	4
A - height mm	1	2
B - height mm	5	6
Order No.	68012081	68012082

#### S TitaniumBase EV



Ø mm	4.1	4.1
A - height mm	1	2
B - height mm	5	6
Order No.	68012083	68012084

#### M TitaniumBase EV



Ø mm	4.7	4.7
A - height mm	1	2
B - height mm	5	6
Order No.	68012088	68012089

#### L TitaniumBase EV



Ø mm	5	5
A - height mm	1	2
B - height mm	5	6
Order No.	68012090	68012091

#### XL TitaniumBase EV\*



Ø mm	5.5	5.5
A - height mm	1	2
B - height mm	5	6
Order No.	68012092	68012093

\* Not applicable for PrimeTaper EV

## 8. Screw-retained restorations

### XS MultiBase Abutment EV



A - height mm	1.5	2.5	3.5
Order No.	68012171	68012172	68012173

### S MultiBase Abutment EV



A - height mm	1.5	2.5	3.5	4.5
Order No.	68012174	68012175	68012176	68012177

### S MultiBase Abutment EV 17°



A - height mm	1.5	2.5	3.5	4.5
B - height mm	3	4	5	6
Order No.	68012178	68012179	68012180	68012181
Order No.	68012182	68012183	68012184	68012185

### S MultiBase Abutment EV 30°



A - height mm	1.5	2.5	1.5	2.5
B - height mm	4	5	4	5
Order No.	68012186	68012187	68012190	68012191

### MultiBase Abutment EV

Titanium alloy<sup>1</sup> with a PEEK® holder, sterile

The MultiBase abutment is used for screw-retained restorations for multi-unit cases.

- Applicable for SmartFix concept
- Straight abutments are one-piece abutments, angled abutments are two-piece abutments
- Top cone (21°) enables bridge insertion on non-parallel abutments up to 42°
- Same prosthetic platform and components for all abutments
- Non-indexed abutments can be seated in any rotational position
- The holder on straight abutment has eight identification grooves, the holder on 17° abutment has four identification grooves, the holder on 30° abutment has six identification grooves
- Restoration: screw retained
- Clinical use: multi-unit restorations
- Color coded
- Straight abutment contains: MultiBase Abutment EV with a plastic holder pre-mounted to the abutment
- MultiBase 17°/30° abutment contains: MultiBase Abutment EV with a separate head part and a plastic holder with a pre-assembled abutment screw
- Instruments needed: Hex Driver for installing the abutment screw. MultiBase Driver for tightening the abutment head to the abutment body and for installing straight abutments
- Indexing options; non-indexed and six positions

Screw-retained restorations

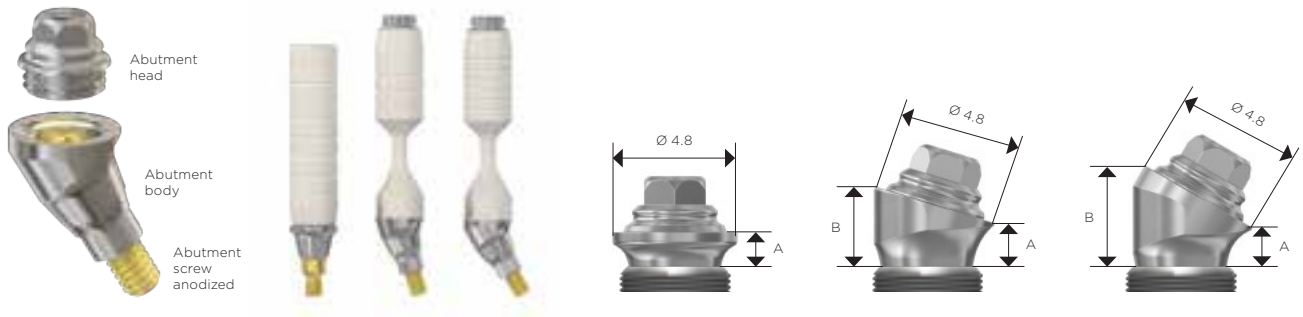



**M** MultiBase Abutment EV



A - height mm	1.5	2.5	3.5	4.5
Order No.	68012194	68012195	68012196	68012197

**M** MultiBase Abutment EV 17°



A - height mm	1.5	2.5	3.5	4.5
B - height mm	3	4	5	6
Order No. 	68012198	68012199	68012200	68012201
Order No. 	68012202	68012203	68012204	68012205

**M** MultiBase Abutment EV 30°



A - height mm	1.5	2.5	1.5	2.5
B - height mm	4	5	4	5
Order No.	68012206	68012207	68012208	68012209

**L MultiBase Abutment EV**



A - height mm	1.5	2.5	3.5	4.5
Order No.	68012210	68012211	68012212	68012213

**L MultiBase Abutment EV 17°**



A - height mm	1.5	2.5	3.5	4.5
B - height mm	3	4	5	6
Order No. ☉	68012214	68012215	68012216	68012217
Order No. ☉	68012218	68012219	68012220	68012352

**L MultiBase Abutment EV 30°**



A - height mm	1.5	2.5	1.5	2.5
B - height mm	4	5	4	5
Order No.	68012221	68012222	68012223	68012224

**XL MultiBase Abutment EV\***



A - height mm	1.5	2.5	3.5	4.5
Order No.	68012225	68012226	68012227	68012228

**Patient specific products - alternative restorative options**



Atlantis Bridge



Atlantis Hybrid



Atlantis BridgeBase

\* Not applicable for PrimeTaper EV

### MultiBase Abutment Head with holder

Titanium alloy<sup>1</sup> with a PEEK<sup>®</sup> plastic holder, sterile

The abutment head with holder is used when needed to replace the abutment head.

- Spare part to Multibase Abutment EV 17° and 30°
- Single use
- Contains: MultiBase Abutment Head with holder; the head part is pre-mounted on the holder

### MultiBase Abutment Head with holder



Order No.	68012229
-----------	----------

### MultiBase Heal Cap

Titanium alloy<sup>1</sup>, sterile

The heal cap is used to protect the abutment and for soft tissue sculpturing during the healing phase.

- One-piece
- Single use

### MultiBase Heal Cap



Ø mm	5.4
Vertical height mm	4
Order No.	68012230

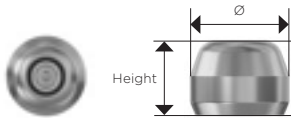

### MultiBase Pick-Up and Transfer

Stainless steel<sup>2</sup>, non-sterile

The pick-up and transfer are used for transferring the MultiBase abutment position to the master model.

- Two-piece pick-up, with a pronounced groove for splinting possibility
- Transfer two-piece
- Screw retained
- Contains: MultiBase Pick-Up and screw
- Contains: MultiBase Transfer and screw

### MultiBase

#### Pick-Up open tray technique



#### Transfer closed tray technique



Ø mm	5.5	5.5
Vertical height mm	15	9.5
Order No.	68012232	68012231

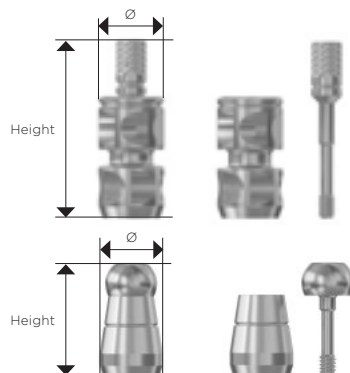



**Protection sleeve**

Order No.	68012241
-----------	----------

**Protection sleeve**Silicone<sup>10</sup>, non-sterile

The protection sleeve is used to protect the soft tissue from acrylic resin.

- Single use

**MultiBase Temporary Cylinder**

Ø mm	5.0
Vertical height mm	12
Order No.	68012239

**MultiBase Temporary Cylinder**Titanium alloy<sup>1</sup>, non-sterile

The temporary cylinder is used for temporary restorations.

- Single use
- Restoration: screw retained
- Clinical use: multi-unit; long-term temporization

Bridge screws need to be ordered separately.

**MultiBase Burnout Cylinder**

Ø mm	4.8
Vertical height mm	10
Order No.	68012240

**MultiBase Burnout Cylinder**PMMA plastic<sup>11</sup>, non-sterile

The burnout cylinder is used for fabricating the final restoration.

- Single use
- Restoration: screw retained
- Clinical use: multi-unit

Bridge screws need to be ordered separately.

**MultiBase Semi-Burnout Cylinder**

Ø mm	5.4
Vertical height mm	14
Order No.	68012243

**MultiBase Semi-Burnout Cylinder**Gold-Platinum alloy<sup>2</sup> / POM plastic<sup>7</sup>, non-sterile

The semi-burnout cylinder is used for fabricating the final restoration.

- Single use
- Restoration: screw retained
- Clinical use: multi-unit

Bridge screws need to be ordered separately.

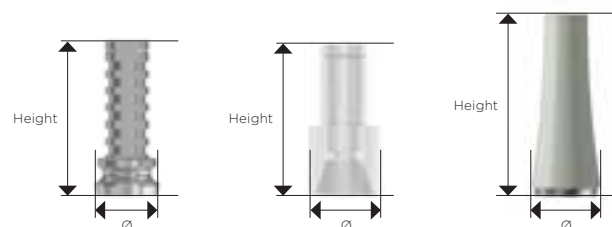

### MultiBase Analog

Stainless steel<sup>3</sup>, non-sterile

The analog is used for laboratory fabrication of abutment-level restorations.

- Single use

### MultiBase Analog



Order No.	68012238
-----------	----------

### MultiBase Bridge Screw

Titanium alloy<sup>3</sup>, non-sterile

The bridge screw is used for connecting the screw-retained restoration to the Multibase abutment.

- Light blue for differentiation to the laboratory bridge screw
- Single use
- Screw head height: 1.65 mm
- Screw head diameter: 2.1 mm
- Contains: 1 MultiBase Bridge Screw

### MultiBase Bridge Screw



	M1.4
Screw head height mm	1.65
Screw head Ø mm	2.1
Order No.	68012233

### MultiBase Lab Bridge Screw

Titanium alloy<sup>3</sup>, non-sterile

The lab bridge screw is used for connecting the screw-retained restoration to the Multibase analog

- Screw head height: 1.65 mm
- Screw head diameter: 2.1 mm
- Contains: 4 pcs

### MultiBase Lab Bridge Screw



	M1.4
Screw head height mm	1.65
Screw head Ø mm	2.1
Order No.	68012237

### MultiBase Lab Abutment Pin

Stainless steel<sup>3</sup>, non-sterile

The lab abutment pin is used for maintaining the screw access channel.

- Designed with a hex at the pin head

### MultiBase Lab Abutment Pin



Length mm	14	18	22
Order No.	68012234	68012235	68012236

## 9. Attachment-retained restorations

### S LOCATOR R-Tx® Abutment EV



A - Ø mm	3.7	3.7	3.7	3.7	3.7	3.7
B - Ø mm	3.4	3.4	3.4	3.4	3.4	3.4
C - height mm	1	2	3	4	5	6
Order No.	68012414	68012415	68012416	68012417	68012418	68012419

### LOCATOR R-Tx® Abutment EV

Titanium alloy<sup>1</sup> / TiCN Coated<sup>6</sup>, non-sterile

The LOCATOR R-Tx® Abutment is used for attachment-retained restorations.

- Ability to accept up to 60 degrees of implant divergence
- Restoration: attachment retained
- Clinical use: multi-unit
- Contains: 1 abutment with complementary components (1 of each: insert Grey, Blue, Pink, Clear, Block-out spacer and Processing assembly)
- Instruments needed: Hex Driver
- Indexing option; non-indexed
- Refer to instructions for use at [www.zestdent.com](http://www.zestdent.com)

### M LOCATOR R-Tx® Abutment EV



A - Ø mm	3.7	3.7	3.7	3.7	3.7	3.7
B - Ø mm	3.7	3.7	3.7	3.7	3.7	3.7
C - height mm	1	2	3	4	5	6
Order No.	68012420	68012421	68012422	68012423	68012424	68012425

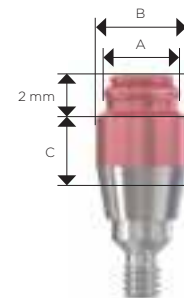

### L LOCATOR R-Tx® Abutment EV

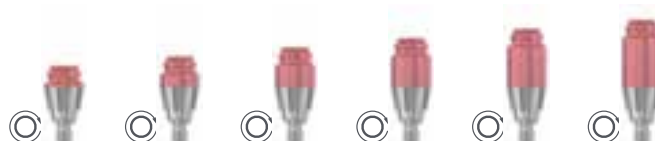

A - Ø mm	3.7	3.7	3.7	3.7	3.7	3.7
B - Ø mm	4.3	4.3	4.3	4.3	4.3	4.3
C - height mm	1	2	3	4	5	6
Order No.	68012426	68012427	68012428	68012429	68012430	68012431

**LOCATOR R-Tx® Retention Insert**

PA plastic<sup>13</sup>, non-sterile

The LOCATOR R-Tx® Retention Insert is used as retention element.

- Two ranges of inserts, both types come in low, medium and high retention
- Standard range inserts can be used for any patient with implant divergence up to a total of 60 degrees
- Limited range inserts are intended for patients with 10 degrees or less of implant divergence to provide a tighter fit
- Color coded by retention strength
- Contains: 4 pcs of the same insert
- Instruments needed: LOCATOR R-Tx® Retention Insert Tool
- Refer to instructions for use at [www.zestdent.com](http://www.zestdent.com)

**LOCATOR R-Tx® Retention Insert Standard range**



Grey



Blue



Pink



Clear

Retention	Zero	Low	Medium	High
Order No.	68012432	68012433	68012434	68012435

**LOCATOR R-Tx® Retention Insert Limited range**



Aqua



Magenta



Gold

Retention	Low	Medium	High
Order No.	68012436	68012437	68012438

**LOCATOR R-Tx® Mixed Retention Limited Range Processing Pack**

- Contains: 2 pcs of each insert Aqua, Magenta, Gold, Block-out spacer and Processing assembly.

**LOCATOR R-Tx® Mixed Retention Limited Range Processing Pack**



Order No.	68012439
-----------	----------

**LOCATOR R-Tx® Denture Attachment Processing Assembly**

Titanium alloy<sup>1</sup> / PE plastic<sup>14</sup>, non-sterile

The LOCATOR R-Tx® Denture Attachment Processing Assembly is used as housing for retention insert in the restoration.

- Contains: 4 pcs (each assembly includes a housing and a pre-assembled Processing insert)
- Refer to instructions for use at [www.zestdent.com](http://www.zestdent.com)

**LOCATOR R-Tx® Denture Attachment Processing Assembly**



Order No.	68012442
-----------	----------

**LOCATOR R-Tx® Block-Out Spacer**

Order No.	68012441
-----------	----------

**LOCATOR R-Tx® Block-Out Spacer**Silicone<sup>10</sup>, non-sterile

The LOCATOR R-Tx® Block-out Spacer is used to eliminate undercuts between non-parallel abutments that excess pick-up material could lock in the denture during the pick-up process.

- Contains: 20 pcs
- Refer to instructions for use at [www.zestdent.com](http://www.zestdent.com)

**LOCATOR R-Tx® Processing Insert**

Order No.	68012440
-----------	----------

**LOCATOR R-Tx® Processing Insert**PE plastic<sup>14</sup>, non-sterile

The LOCATOR R-Tx® Processing Insert is used as a place holder for retention inserts inside the housing during the fabrication of the restoration.

- Contains: 4 pcs
- Instruments needed: LOCATOR R-Tx® Retention Insert Tool
- Refer to instructions for use at [www.zestdent.com](http://www.zestdent.com)

**LOCATOR R-Tx® Processing Spacer**

Order No.	68012445
-----------	----------

**LOCATOR R-Tx® Processing Spacer**POM plastic<sup>7</sup>, non-sterile

The LOCATOR R-Tx® Processing Spacer is used for indirect processing of the attachment housings.

- Contains: 4 pcs
- Refer to instructions for use at [www.zestdent.com](http://www.zestdent.com)

**LOCATOR R-Tx® Abutment Analog Ø4**

Ø mm	4
Order No.	68012443

**LOCATOR R-Tx® Abutment Analog Ø4**Titanium alloy<sup>1</sup>, non-sterile

The LOCATOR R-Tx® Abutment Analog is used for laboratory fabrication of abutment-level restorations.

- Contains: 4 pcs
- Refer to instructions for use at [www.zestdent.com](http://www.zestdent.com)

### LOCATOR R-Tx® Impression Coping

POM plastic<sup>7</sup>, non-sterile

The LOCATOR R-Tx® Impression Coping is used for transferring the LOCATOR R-Tx® Abutment position to the master model.

- Closed tray impression procedure
- Contains: 4 pcs
- Refer to instructions for use at [www.zestdent.com](http://www.zestdent.com)

### LOCATOR R-Tx® Impression Coping



Order No.	68012444
-----------	----------

### LOCATOR R-Tx® Retention Insert Tool

Stainless steel<sup>3</sup> / POM plastic<sup>7</sup>, non-sterile

The LOCATOR R-Tx® Retention Insert Tool is used for insertion and removal of the LOCATOR R-Tx® Retention Insert.

- Metal slot on the back of the tool for disengaging the retention insert
- Contains: a two-piece instrument
- Refer to instructions for use at [www.zestdent.com](http://www.zestdent.com)

### LOCATOR R-Tx® Retention Insert Tool



Order No.	68012446
-----------	----------

## 10. Friction-retained restorations

### 3.6 Conometric Abutment EV 0° Ø 3.3

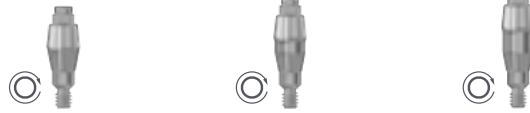

Ø mm	3.3	3.3	3.3
A - height mm	1	2	3
Order No.	26115	26116	26117

### 3.6 Conometric Abutment EV 0° Ø 4.5



Ø mm	4.5	4.5	4.5
A - height mm	1	2	3
Order No.	26121	26122	26123

### 3.6 Conometric Abutment EV 15° Ø 4.5



Ø mm	4.5	4.5	4.5
A - height mm	1	2	3
B - height mm	2.1	3.1	4.1
Order No.	26127	26128	26129

### 4.2 Conometric Abutment EV 0° Ø 4.5

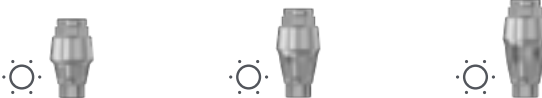

Ø mm	4.5	4.5	4.5
A - height mm	1	2	3
Order No.	26124	26125	26126

### 4.2 Conometric Abutment EV 15° Ø 4.5



Ø mm	4.5	4.5	4.5
A - height mm	1	2	3
B - height mm	2.1	3.1	4.1
Order No.	26130	26131	26132

### Conometric Abutment EV

Titanium alloy<sup>1</sup>, sterile

The Conometric Abutment is used for friction-retained restorations.

- Restoration: single tooth fixed restorations
- Two diameters, same prosthetic interface and components for all abutments of the same diameter
- Straight Ø 3.3 mm abutments are one-piece
- Instruments needed: Conometric Abutment Driver for installing straight Ø 3.3 mm one-piece abutments and Hex Driver for installing angled abutments
- Indexing option: non-indexed and six-positions

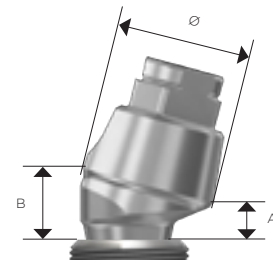
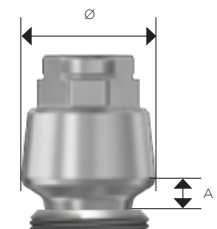

Astra Tech Implant System EV product assortment.  
See connection size conversion on page 4.

### Conometric Healing Cap

PEEK plastic®, one-piece, non-sterile

The conometric healing cap is a protection for the abutment when a temporary crown is not used.

- Clinical use: can be used up to six months
- Single use

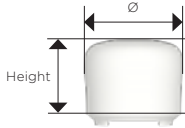

### Conometric Healing Cap



Conometric abutment size Ø mm	3.3	3.3	4.5
Ø mm	4.8	6.0	6.0
Height mm	5.3	5.3	5.3
Order No.	31072101	31072102	31072103

### Conometric Impression Cap

PEEK plastic®, non-sterile

The conometric impression cap is used to capture the abutment position.

- Single use

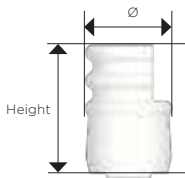

### Conometric Impression Cap



Conometric abutment size Ø mm	3.3	4.5
Ø mm	5.4	5.4
Height mm	8.3	8.3
Order No.	31072001	31072002

### Conometric Temporization Cap

Cap Ø 3.3/4.6: Titanium Alloy-ELI<sup>2</sup>/PEEK plastic®, non-sterile, single-use

Cap Ø 4.5/5.8: PEEK plastic®, non-sterile

The conometric temporization cap is used as a base for a temporary crown.

- Clinical use: can be used up to six months
- Single use

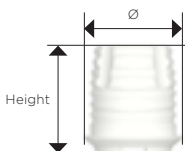

### Conometric Temporization Cap



Conometric abutment size Ø mm	3.3	4.5
Ø mm	4.6	5.8
Height mm	5	5.3
Order No.	31072112	31072114

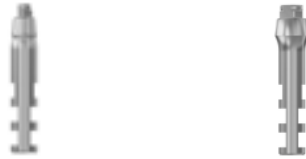

**Conometric Analog**

Conometric abutment size Ø mm	3.3	4.5
Height mm	20	20
Order No.	31047210	31072020

**Conometric Analog**Stainless steel<sup>3</sup>, non-sterile

The conometric analog corresponds to the abutment and is used in the master model.

- Single use

**Conometric Lab Cap**

Conometric abutment size Ø mm	3.3	4.5
Ø mm	4.6	5.8
Height mm	5	5
Order No.	31072121	31072123

**Conometric Lab Cap**Titanium alloy<sup>3</sup>, non-sterile

The conometric lab cap is used by the dental lab when fabricating the crown.

- Single use

**Conometric Final Cap**

Conometric abutment size Ø mm	3.3	4.5
Ø mm	4.6	5.8
Height mm	5	5
Order No.	31072301	31072303

**Conometric Final Cap**Titanium grade 4<sup>2</sup>, TiN-coated<sup>5</sup>, non-sterile

The conometric final cap is used as a base when cementing the final crown.

- Single use

# 11. Restorative instruments

## Hex Driver Manual

Stainless steel<sup>3</sup>, non-sterile

The hex driver is used for tightening screws, surgical and restorative components.

## Hex Driver Manual



Total length mm	20	31
Order No.	25771	25772

## Hex Driver

Stainless steel<sup>3</sup>, non-sterile

The hex driver is used for tightening screws, surgical and restorative components.

## Hex Driver



Total length mm	20	24	35
Order No.	68015207	68015205	68015206

## Atlantis Angulated Screw Access Screwdriver

Stainless steel<sup>3</sup>, non-sterile

The Atlantis Angulated Screw Access Screwdriver is used for components with Hex interface.

- Must be used in combination with Atlantis implant restorations that have been designed and manufactured with Angulated Screw Access on 1 or more connections
- Allows screw access up to 30 degrees

Every connection with angulated screw access is supplied with a corresponding Atlantis prosthetic screw.

## Atlantis Angulated Screw Access Screwdriver



Total length mm	18	24	32
Order No.	36030	36031	36032

## MultiBase Driver

Stainless steel<sup>3</sup>, non-sterile

The MultiBase driver is used for installation and removal of the MultiBase abutment.

- Restoration: screw retained

## MultiBase Driver



Total length mm	19
Order No.	68012244

### Conometric Abutment Driver



Ø mm	3.3	3.3
Height mm	25	20
Order No.	31072909	31072910

### Conometric Abutment Driver

Stainless steel<sup>3</sup>, non-sterile

The conometric abutment driver is used for installation and removal of one-piece Conometric Abutments.

- Restoration: friction-retained

### Torque Wrench EV



Order No.	25774
-----------	-------

### Torque Wrench EV

Stainless steel<sup>3</sup>, non-sterile

The torque wrench is used together with the surgical driver handle or the restorative driver handle for tightening and measuring the torque.

- Used together with the Surgical Driver Handle for implant installation and adjustment
- Used together with the Restorative Driver Handle for tightening abutments and/or bridge screws
- Refer to instructions for use at [www.elosmedtech.com](http://www.elosmedtech.com)

### Torque Wrench EV Surgical Driver Handle



Order No.	25775
-----------	-------

### Torque Wrench EV Surgical Driver Handle

Stainless steel<sup>3</sup>, non-sterile

The surgical driver handle is used together with the torque wrench and a surgical instrument.

### Torque Wrench EV Restorative Driver Handle



Low

Order No.	25776	25777
-----------	-------	-------

### Torque Wrench EV Restorative Driver Handle

Stainless steel<sup>3</sup>, non-sterile

The restorative driver handle is used together with the torque wrench and a restorative instrument for tightening abutment and/or bridge screws.

### Conometric Temporization Cap Insertion Tool

Stainless steel<sup>3</sup>, non-sterile

The temporization cap insertion tool is used for carrying the cap to the abutment and snapping the cap in to place.

- The insertion tool Ø 3.3 is marked with one groove for identification and the insertion tool Ø 4.5 is marked with two grooves

### Conometric Temporization Cap Insertion Tool



Ø mm	3.3	4.5
Height mm	24.5	24.5
Order No.	31033636	31033637

### Conometric Fixation Tool

Stainless steel<sup>3</sup>, non-sterile

The conometric fixation tool activates the friction retention between final cap/final crown and abutment by a combination of pressure and impulse.

### Conometric Fixation Tool



Order No.	31072911
-----------	----------

### Conometric Fixation Tool Tip

PEEK plastic<sup>8</sup>, non-sterile

The conometric fixation tool tip is applied on the tip of conometric fixation tool.

- Single use

### Conometric Fixation Tool Tips



	Tip Convex (5 pcs)	Tip U-shape (5 pcs)	Tip Concave (5 pcs)
Height mm	11	9.5	10.5
Recommended use	Pre molar/molar	Incisors	Canine/pre molar
Order No.	31072906	31072907	31072908

### Atlantis FLO screwdriver

Stainless steel<sup>3</sup>, non-sterile

Required for Atlantis FLO, used with lab-based scanning.

### Atlantis FLO screwdriver



Order No.	34601
-----------	-------



### Prosthetic Tray

PPSU plastic<sup>9</sup> / Silicone<sup>10</sup>, non-sterile

The Prosthetic tray is used for sterilization and storage of restorative instruments.

- Integrated silicone holders
- Scannable QR code for further information

### Prosthetic Tray

	Length	Width	Height
Measurements mm	97.8	136.5	61.5
Order No.	68015288		

# Product catalog

## Profile EV prosthetics

Components compatible with Astra Tech Implant EV Profile are presented in this catalog.

Non-indexed components designed for implants with EV connection can also be used for Astra Tech Implant EV Profile.

Indexed components designed for implants with EV connection cannot be used for Astra Tech Implant EV Profile.



Astra Tech Implant System EV product assortment.  
See connection size conversion on page 4.

## 12. Introduction to the Profile EV prosthetics assortment

Throughout the prosthetic assortment you will find color-coding, markings and geometrical designs to simplify the correct identification of corresponding components.

Implant-abutment connection size is identified by a specific color. The color is applied directly to components and instruments, as well as on packaging and informational material, where appropriate.



### Implant-abutment connection

#### Astra Tech Implant EV Profile

Astra Tech Implant EV Profile has a unique interface with one-position-only placement of all indexed components and includes an option for non-indexed placement.

#### One-position-only

All Atlantis patient-specific abutments and indexed components for Astra Tech Implant EV Profile will seat in one-position-only.



#### Non-indexed

Non-indexed abutments will be seated in any rotational position.



Refer to page 5 for more information about the EV connection and the three different options for abutment placement/indexing.

# P<sub>4.2</sub> M Overview

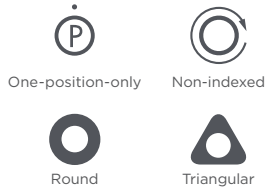

## Cover screw

### Cover Screw Profile 4.2

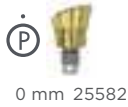

## Healing abutments

### HealDesign Profile EV 4.2

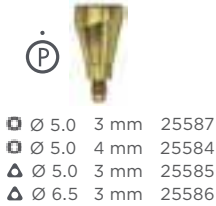

### HealDesign EV

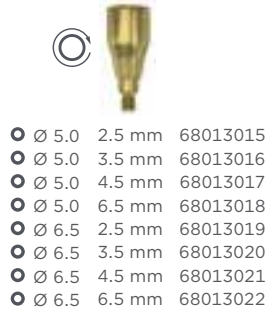

### Healing Abutment EV



## Cement-retained

### Temporary abutments

#### TempDesign Profile EV\*

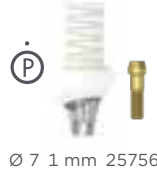

#### Temp Abutment Profile EV\*

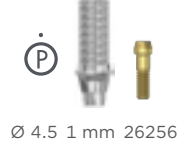

### Abutments

#### TiDesign Profile EV 4.2

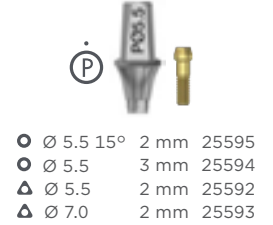

\*Also for screw-retained single tooth restoration

## Screw-retained

### Abutments

#### MultiBase Abutment EV



### Healing caps

#### MultiBase Heal Cap

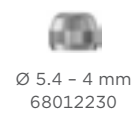

### Impressions

#### MultiBase Pick-Up



#### MultiBase Transfer



## Attachment-retained

### Abutments

#### LOCATOR R-Tx® Abutment EV

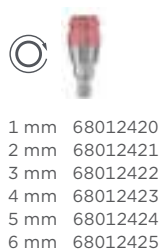

### Abutment impressions

#### LOCATOR R-Tx® Impression Coping



### Analog

#### LOCATOR R-Tx® Abutment Analog



Non-indexed components including healing abutments, MultiBase abutments and LOCATOR R-Tx® abutments are compatible with Astra Tech Implant EV Profile.



**Implant impressions**

Implant Pick-Up Profile EV



Short 26258

Implant Pick-Up Design Profile EV



26262

Implant Transfer Profile EV



Short 25606  
Long 25607

**Lab products**

Lab Abutment Screw



68014031

Implant Replica Profile EV



25610

**Lab products**

MultiBase Lab Bridge Screw



68012237

MultiBase Analog



68012238

MultiBase Lab Abutment Pin



14 mm 68012234  
18 mm 68012235  
22 mm 68012236

**Cylinders**

MultiBase Temporary Cylinder



68012239

MultiBase Burnout Cylinder



68012240

MultiBase Semi-Burnout Cylinder



68012243

**Bridge screws**

MultiBase Bridge Screw



68012233

**Attachment components**

LOCATOR R-Tx® Mixed Retention Limited Range Processing Pack



68012439

LOCATOR R-Tx® Retention Insert Standard range



Grey 68012432  
Blue 68012433  
Pink 68012434  
Clear 68012435

LOCATOR R-Tx® Retention Insert Limited range



Aqua 68012436  
Magenta 68012437  
Gold 68012438

LOCATOR R-Tx® Processing Insert



68012440

LOCATOR R-Tx® Block-Out Spacer



68012441

LOCATOR R-Tx® Denture Attachment Processing Assembly



68012442

LOCATOR R-Tx® Processing Spacer



68012445

# P<sub>4.8</sub> L Overview

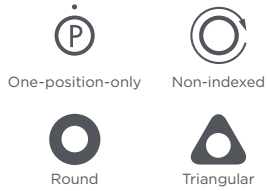

## Cover screw

### Cover Screw Profile 4.8

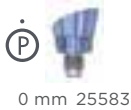

## Healing abutments

### HealDesign Profile EV 4.8



### HealDesign EV



### Healing Abutment EV



## Cement-retained

### Temporary abutments

#### TempDesign Profile EV\*

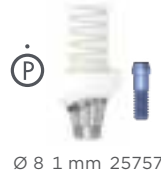

#### Temp Abutment Profile EV\*

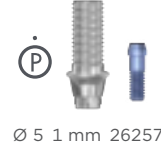

### Abutments

#### TiDesign Profile EV 4.8

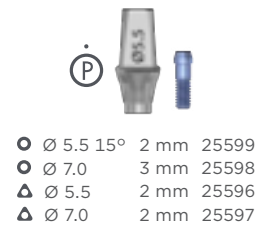

\*Also for screw-retained single tooth restoration

## Screw-retained

### Abutments

#### MultiBase Abutment EV



### Healing caps

#### MultiBase Heal Cap

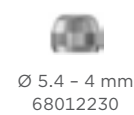

### Impressions

#### MultiBase Pick-Up



#### MultiBase Transfer

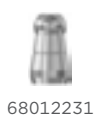

## Attachment-retained

### Abutments

#### LOCATOR R-Tx® Abutment EV

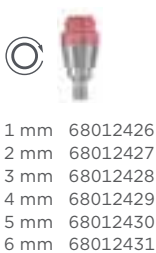

### Abutment impressions

#### LOCATOR R-Tx® Impression Coping



### Analog

#### LOCATOR R-Tx® Abutment Analog



Non-indexed components including healing abutments, MultiBase abutments and LOCATOR R-Tx® abutments are compatible with Astra Tech Implant EV Profile.

### Implant impressions

Implant Pick-Up Profile EV



Short 26259

Implant Pick-Up Design Profile EV



26263

Implant Transfer Profile EV



Short 25608  
Long 25609

### Lab products

Lab Abutment Screw



68014032

Implant Replica Profile EV



25611

### Lab products

MultiBase Lab Bridge Screw



68012237

MultiBase Analog



68012238

MultiBase Lab Abutment Pin



14 mm 68012234  
18 mm 68012235  
22 mm 68012236

### Cylinders

MultiBase Temporary Cylinder



68012239

MultiBase Burnout Cylinder



68012240

MultiBase Semi-Burnout Cylinder



68012243

### Bridge screws

MultiBase Bridge Screw



68012233

### Attachment components

LOCATOR R-Tx® Mixed Retention Limited Range Processing Pack



68012439

LOCATOR R-Tx® Retention Insert Standard range



Grey 68012432  
Blue 68012433  
Pink 68012434  
Clear 68012435

LOCATOR R-Tx® Retention Insert Limited range



Aqua 68012436  
Magenta 68012437  
Gold 68012438

LOCATOR R-Tx® Processing Insert



68012440

LOCATOR R-Tx® Block-Out Spacer



68012441

LOCATOR R-Tx® Denture Attachment Processing Assembly



68012442

LOCATOR R-Tx® Processing Spacer



68012445

# 14. Cover screws

## Cover Screw Profile

Titanium alloy<sup>1</sup>, sterile

The cover screw is used for sealing the implant interface.

- Self-guiding component; engages into the implant when correctly seated
- One height option for each implant abutment connection size.
- Two-piece cover screw with color coded sleeve. The included screw is without color.
- Clinical use: two-stage surgical procedures
- Color coded
- Indexing options; one-position only

## Cover Screw Profile



Order no.	25582	25583
-----------	-------	-------

# 15. Healing abutments

## HealDesign Profile EV

Titanium alloy<sup>1</sup>, sterile

The HealDesign is used for soft tissue sculpturing during the healing phase.

- The design of the healing abutments is based upon the natural dentition utilizing a site-specific, crown-down approach.
- The design mimic a variety of tooth shapes and support the soft tissue preparing for the final abutment.
- Heights and diameters are harmonized with the final abutments and with the expected tooth positions.
- HealDesign Profile is a two-piece abutment.
- Self-guiding component; engages into the implant only when correctly seated.
- Marked with diameter, height and P for profile
- Clinical use: one- and two-stage surgery
- Color coded
- Contains: HealDesign Profile EV and color-coded Abutment Screw
- Indexing options; one-position only

## P<sub>4.2</sub> HealDesign Profile EV 4.2

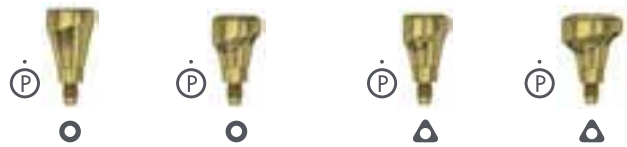

Ø mm	5	5	5	6.5
A - height mm	5	4	4.5	4
B - height mm	4	3	3	3
Order no.	25584	25587	25585	25586

## P<sub>4.8</sub> HealDesign Profile EV 4.8

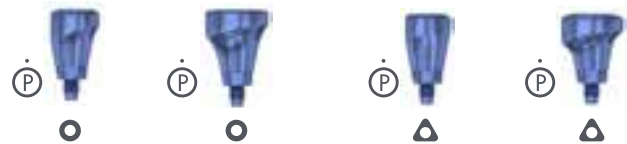

Ø mm	5	6.5	5	6.5
A - height mm	4.5	5.5	4.5	4.5
B - height mm	3	4	3	3
Order no.	25591	25589	25588	25590

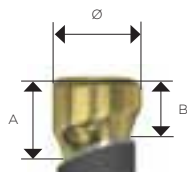

Round shapes are indicated for all positions in the mouth.

Triangular shapes are designed for anterior implant sites and mimic the specific shape for incisors and canines.

One-piece non-indexed healing abutments can also be used.

# 16. Temporary abutments

## Temp Abutment Profile EV

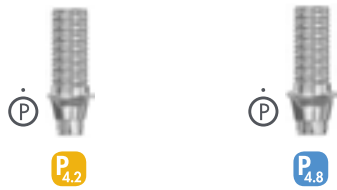

Ø mm	4.5	5.0
A - buccal height mm	1	1
B - lingual height mm	1	1
Vertical height mm	9	9
Order no.	26256	26257

## Temp Abutment Profile EV

Titanium alloy<sup>1</sup>, non-sterile

The temporary abutment is used as a customizable base for temporary implant-level restorations and allows for further sculpturing of the soft tissue.

- Designed for build-up technique
- Primarily processed in the laboratory
- Restoration: screw- and cement-retained
- Screw-retained restorations, limited to single-tooth only
- Clinical use: long-term temporization
- Contains: TempAbutment Profile EV and corresponding color-coded Abutment Screw EV
- Indexing option; one-position only

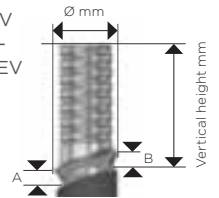

## TempDesign Profile EV

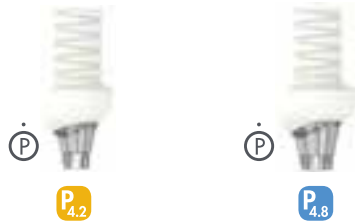

Ø mm	7	8
A - buccal height mm	1	1
B - lingual height mm	1	1
Vertical height mm	12	12
Order no.	25756	25757

## TempDesign Profile EV

Titanium alloy<sup>1</sup> / PEEK plastic<sup>2</sup>, non-sterile

The TempDesign abutment is designed for reduction technique.

- Can be processed chairside or in the laboratory
- Restoration: screw- and cement-retained
- Screw-retained restorations limited to single-tooth only
- Clinical use: max 180 days
- Contains: TempDesign Profile EV and corresponding color-coded Abutment Screw EV
- Indexing option; one-position only

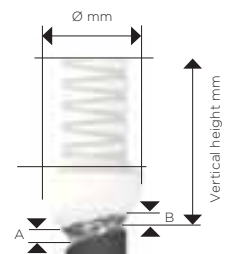

## Patient specific products – alternative restorative options



Atlantis Healing Abutment



Atlantis CustomBase Solution – Atlantis Abutment and Atlantis Temporary Crown

## Abutment Screw EV

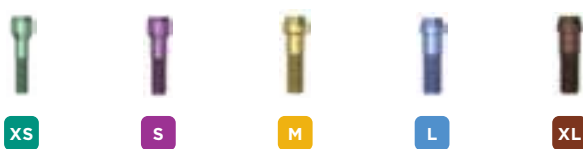

	M1.4	M1.6	M1.8	M2.0	M2.0
Order No.	68012166	68012167	68012168	68012169	68012170

## Abutment Screw EV

Titanium alloy<sup>1</sup>, non-sterile

The abutment screw is used for securing the abutment to the implant.

- A corresponding abutment screw is included with every two-piece abutment.
- Additional screws can be ordered separately
- Color coded

# 17. Impression and laboratory components

## Implant Pick-Up Profile EV / Implant Pick-Up Design Profile EV

Titanium alloy<sup>1</sup>, non-sterile

The implant pick-up is used for transferring the implant position and the soft tissue anatomy to the master model.

- Self-guiding impression component
- Integrated pin for safe handling
- Designed with a hex at the pin head
- One-hand-procedure
- Implant Pick-Up Design EV is designed for splinting possibilities
- Clinical use: open tray impression procedure
- Marked with P for Profile
- Color coded
- Contains: In both Implant Pick-Up Profile EV and Implant Pick-Up Design Profile EV, the pin is included
- Instruments needed: Hex Driver (optional)

### Implant Pick-Up Profile EV, Short



Ø mm	4.6	4.6
Height mm	16.5	16.5
Order no.	26258	26259

### Implant Pick-Up Design Profile EV

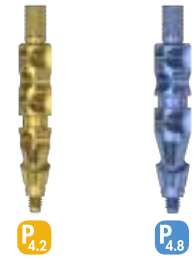

Ø mm	4.2	4.8
Height mm	22	22
Order no.	26262	26263

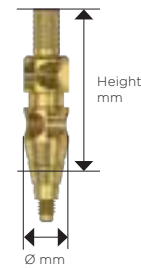
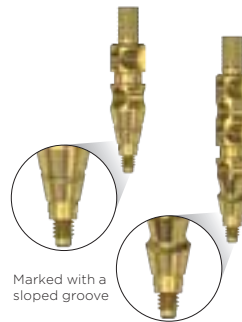

## Implant Transfer Profile EV

Titanium alloy<sup>1</sup>, non-sterile

The implant transfer is used for transferring the implant position and the soft tissue anatomy to the master model.

- Self-guiding impression component
- Integrated pin for safe handling
- One-hand procedure
- Designed with a hex at the pin head
- Clinical use: closed tray impression procedure
- Marked with a P for Profile
- Color coded
- Contains: Implant Transfer Profile with pin
- Instruments needed: Hex Driver (optional)

### Implant Transfer Profile EV, Short



Ø mm	4.2	4.8
Height mm	11	11
Order no.	25606	25608

### Implant Transfer Profile EV, Long



Ø mm	4.2	4.8
Height mm	14	14
Order no.	25607	25609

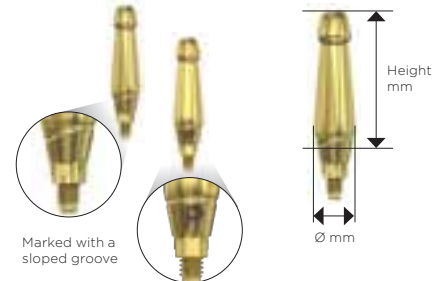

## Implant Replica Profile EV

Titanium alloy<sup>1</sup>, non-sterile

Adjustment of apex allow for removal of replica from master model without need for sectioning.

### Implant Replica Profile EV



Height mm	16.5	16.5
Order no.	25610	25611

## Scan components

### Atlantis IO FLO



Intraoral scan



IO FLO code	IO P-06	IO P-07
Order No.	35248	35249

### Atlantis FLO



Lab scan



FLO code	P-06	P-07
Order No.	34598	34599

### Atlantis IO FLO

Titanium alloy<sup>1</sup> / PEEK plastic<sup>8</sup>, non-sterile

### Atlantis FLO

Stainless steel<sup>3</sup> / POM plastic<sup>7</sup>, non-sterile

Atlantis IO FLO is a scan body used for implant level digital impressions.

Atlantis FLO is a scan body used for implant level model scanning.

- Can be used with all connectivity when scanning for Atlantis abutments.
- Enables the design software to create a sufficient output to produce the restoration onto the TitaniumBase
- Instruments needed: Hex Driver for Atlantis IO FLO and Atlantis FLO screwdriver for Atlantis FLO.

### Atlantis IO FLO-S

Implant level



FLO code	A04M	A04N
Order No.	68020020	68020021

Abutment level



MultiBase Abutment EV	
FLO code	A04S
Order No.	68020034

### Atlantis IO FLO-S

Titanium<sup>2</sup>, non-sterile

The storage trays are made from aluminium with silicone grommets.

Atlantis IO FLO-S is a scan body used for implant or abutment level digital impressions.

- Atlantis IO FLO-S is used when scanning for Atlantis suprastructure.
- Can be used for both intraoral and model scanning.

The FLO-S scan body without the IO marking can only be used for model scanning and is not approved for intraoral scanning.

### Lab Abutment Screw EV

Titanium alloy<sup>3</sup>, non-sterile

The lab abutment screw is used to secure the abutment on the implant analog.

- Designed for use with implant analog only
- Color coded
- Contains:  
4 pcs of Lab Abutment Screw EV

### Lab Abutment Screw EV

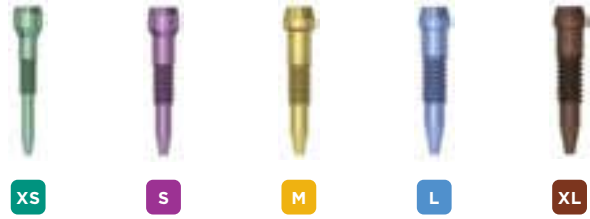

Order No.	68014029	68014030	68014031	68014032	68014033
-----------	----------	----------	----------	----------	----------

## 18. Cement-retained restorations

### TiDesign Profile EV

Titanium alloy<sup>3</sup>, non-sterile

TiDesign is used as a base for cement-retained restorations.

- Anatomically pre-designed abutment
- Round – design for the majority of tooth shapes
- Triangular – primarily for incisors and canines with distinct triangular shape
- Angled – for offset situations both in the anterior and posterior regions, compensating for implants with a restoratively unfavorable angulation.
- Restoration: cement retained
- Clinical use: single and multi unit restorations
- Marked with connection size, diameter and P for Profile
- Color coded
- Contains: TiDesign Profile EV and corresponding color-coded Abutment Screw EV.
- Indexing option; one-position only

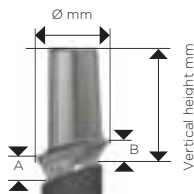

### P<sub>4.2</sub> TiDesign Profile EV 4.2

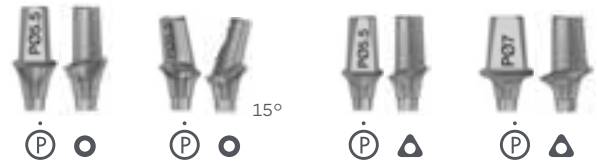

Ø mm	5.5	5.5	5.5	7.0
A – buccal height mm	3	2	2	2
B – lingual height mm	3	2	2	2
Vertical height mm	9.5	8.5	8.5	8.5
Order no.	25594	25595	25592	25593

### P<sub>4.8</sub> TiDesign Profile EV 4.8

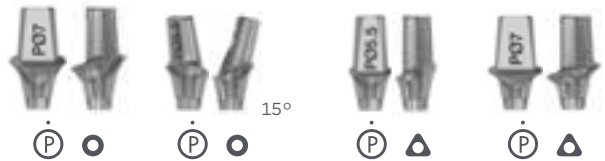

Ø mm	7.0	5.5	5.5	7.0
A – buccal height mm	3	2	2	2
B – lingual height mm	3	2	2	2
Vertical height mm	9	8	8	8
Order no.	25598	25599	25596	25597

### Patient specific products – alternative restorative options



Atlantis Abutment



Atlantis Crown Abutment



Atlantis CustomBase Solution – Atlantis Abutment and Atlantis Crown



## 19. Screw-retained restorations

### MultiBase Abutment EV

Non-indexed MultiBase Abutment EV are compatible with Astra Tech Implant EV Profile.

See product overview on page 10, 12, 48, 50 and product assortment on page 30, 31.



## 20. Attachment-retained restorations

### LOCATOR R-Tx® Abutment EV

LOCATOR R-Tx Abutment EV are compatible with Astra Tech Implant EV Profile.

See product overview on page 10, 12, 48, 50 and product assortment on page 35.



### Patient specific products – alternative restorative options



Atlantis Bridge



Atlantis Hybrid



Atlantis BridgeBase

## 21. Appendix

### Acuris conometric concept

Acuris is a paradigm shift in prosthetic retention of single crowns that are fixed yet retrievable by the clinician. The friction-based retention offers a fixation mode providing the esthetics of a cement-retained crown, maintaining retrievability and excluding the risk of submucosal residual cement.



For further information and step-by-step procedures refer to [Acuris conometric concept manual for Astra Tech Implant System EV.](#)

---

### Atlantis customized patient-specific restorations

As part of the digital implant solutions offered by Dentsply Sirona, Atlantis delivers patient-specific prosthetic solutions for all major implant systems\* providing an excellent foundation for optimal function and esthetics.

By utilizing the unique design software, suprastructures, abutments and crowns will be individually designed from the final tooth shape. This is a significant advantage for achieving a more natural, esthetic result and optimized function.



\* For further information, compatible charts, manual and instructions, go to [www.orderdigitalsolutions.com](http://www.orderdigitalsolutions.com)

---

### Patient information material

With education comes knowledge - we offer a variety of easy-to-understand information material about implant treatment for your patients so that they can make an informed decision about their oral health.

Contact your Dentsply Sirona sales representative or customer service for more information.



## 22. Material specifications

Index\* will be found at material description for specific products.

### Metals

Type	Index	Composition/Designation	Standard
Titanium alloy	1	Titanium-6Aluminum-4Vanadium	ASTM F136
Titanium	2	Pure titanium	ASTM F67
Stainless steel	3		ASTM F899
Gold-Platinum Alloy	4	Au 60%, Pd 20%, Pt 19%, Ir 1%	
TiN Coated	5	Titanium Nitride	
TiCN Coated	6	Titanium Carbon Nitride	

### Plastic

Type	Index	Composition/Designation	Standard
POM plastic	7	Polyoxymethylene	
PEEK plastic	8	Polyetheretherketon	
PPSU plastic	9	Polyphenylsulfone	
Silicone	10		
PMMA plastic	11	Polymethylenemethacrylate	
PP plastic	12	Polypropylene	
PA plastic	13	Polyamide	
PE plastic	14	Polyethylene	

# 23. Index

## By order number

Order No.	page
25503	TempDesign EV 3.0 Ø6 5mm.....19
25504	TempDesign EV 3.6 Ø7 5mm.....19
25505	TempDesign EV 4.2 Ø9 5mm.....19
25506	TempDesign EV 4.8 Ø10 5mm.....19
25507	TempDesign EV 5.4 Ø10 5mm.....19
25582	Cover Screw Profile 4.2.....48, 52
25583	Cover Screw Profile 4.8.....50, 52
25584	HealDesign Profile EV 4.2 Ø5 5mm.....48, 52
25585	HealDesign Profile EV 4.2 Ø5 4.5mm.....48, 52
25586	HealDesign Profile EV 4.2 Ø6.5 4mm.....48, 52
25587	HealDesign Profile EV 4.2 Ø5 4mm.....48, 52
25588	HealDesign Profile EV 4.8 Ø7.0 2mm.....50, 52
25589	HealDesign Profile EV 4.8 Ø6.5 5.5mm.....50, 52
25590	HealDesign Profile EV 4.8 Ø6.5 4.5mm.....50, 52
25591	HealDesign Profile EV 4.8 Ø5 4.5mm.....50, 52
25556	TempDesign Profile EV 4.2 Ø7.....48, 53
25557	TempDesign Profile EV 4.8 Ø8.....50, 53
25592	TiDesign Profile EV 4.2 Ø5.5 2mm.....48, 56
25593	TiDesign Profile EV 4.2 Ø7.0 2mm.....48, 56
25594	TiDesign Profile EV 4.2 Ø5.5 3mm.....48, 56
25595	TiDesign Profile EV 4.2 Ø5.5 15° 2mm.....48, 56
25596	TiDesign Profile EV 4.8 Ø5.5 2mm.....50, 56
25597	TiDesign Profile EV 4.8 Ø7.0 2mm.....50, 56
25598	TiDesign Profile EV 4.8 Ø7.0 5 3mm.....50, 56
25599	TiDesign Profile EV 4.8 Ø5.5 15° 2mm.....50, 56
25606	Implant Transfer Profile EV 4.2 short.....49, 54
25607	Implant Transfer Profile EV 4.2 long.....49, 54
25608	Implant Transfer Profile EV 4.8 short.....51, 54
25609	Implant Transfer Profile EV 4.8 long.....51, 54
25610	Implant Replica Profile EV 4.2.....49, 54
25611	Implant Replica Profile EV 4.8.....51, 54
25771	Hex Driver 20mm manual.....42
25772	Hex Driver 31mm manual.....42
25774	Torque Wrench EV.....43
25775	Torque Wrench EV Surgical Driver Handle.....43
25776	Torque Wrench EV Restorative Driver Handle.....43
25777	Torque Wrench EV Restorative Driver Handle Low.....43
26115	Conometric Abutment EV 3.6 0° Ø3.3 1mm NI.....8, 39
26116	Conometric Abutment EV 3.6 0° Ø3.3 2mm NI.....8, 39
26117	Conometric Abutment EV 3.6 0° Ø3.3 3mm NI.....8, 39
26121	Conometric Abutment EV 3.6 0° Ø4.5 1mm.....8, 39
26122	Conometric Abutment EV 3.6 0° Ø4.5 2mm.....8, 39
26123	Conometric Abutment EV 3.6 0° Ø4.5 3mm.....8, 39
26127	Conometric Abutment EV 3.6 15° Ø4.5 1mm.....8, 39
26128	Conometric Abutment EV 3.6 15° Ø4.5 2mm.....8, 39
26129	Conometric Abutment EV 3.6 15° Ø4.5 3mm.....8, 39
26124	Conometric Abutment EV 4.2 0° Ø4.5 1mm.....10, 39
26125	Conometric Abutment EV 4.2 0° Ø4.5 2mm.....10, 39
26126	Conometric Abutment EV 4.2 0° Ø4.5 3mm.....10, 39
26130	Conometric Abutment EV 4.2 15° Ø4.5 1mm.....10, 39
26131	Conometric Abutment EV 4.2 15° Ø4.5 2mm.....10, 39
26132	Conometric Abutment EV 4.2 15° Ø4.5 3mm.....10, 39
26256	Temp Abutment Profile EV 4.2 Ø4.5.....48, 53
26257	Temp Abutment Profile EV 4.8 Ø5.0.....50, 53
26258	Implant Pick-Up Profile EV 4.2 short.....49, 54
26259	Implant Pick-Up Profile EV 4.8 short.....51, 54
26262	Implant Pick-Up Design Profile EV 4.2.....49, 54
26263	Implant Pick-Up Design Profile EV 4.8.....51, 54
31033636	Conometric Temporization Cap Insertion Tool Ø3.3.....44
31033637	Conometric Temporization Cap Insertion Tool Ø4.5.....44
31047210	Conometric Analog Ø3.3.....9, 11, 41
31072001	Conometric Impression Cap Ø3.3/5.4.....9, 11, 40
31072002	Conometric Impression Cap Ø4.5/5.4.....9, 11, 40
31072020	Conometric Analog Ø4.5.....9, 11, 41
31072101	Conometric Healing Cap Ø3.3/4.8.....9, 11, 40
31072102	Conometric Healing Cap Ø3.3/6.0.....9, 11, 40
31072103	Conometric Healing Cap Ø4.5/6.0.....9, 11, 40

Order No.	page
31072112	Conometric Temporization Cap Ø3.3/4.6.....8, 10, 40
31072114	Conometric Temporization Cap Ø4.5/5.8.....8, 10, 40
31072121	Conometric Lab Cap Ø3.3/4.6.....9, 11, 41
31072123	Conometric Lab Cap Ø4.5/5.8.....9, 11, 41
31072301	Conometric Final Cap Ø3.3.....9, 11, 41
31072303	Conometric Final Cap Ø4.5.....9, 11, 41
31072906	Conometric Fixation Tool Tip Convex (5 pcs).....44
31072907	Conometric Fixation Tool Tip U-shape (5 pcs).....44
31072908	Conometric Fixation Tool Tip Concave (5 pcs).....44
31072909	Conometric Abutment Driver Ø3.3 25mm.....43
31072910	Conometric Abutment Driver Ø3.3 20mm.....43
31072911	Conometric Fixation Tool.....44
34593	Atlantis FLO P-01 (XS).....23
34594	Atlantis FLO P-02 (S).....23
34595	Atlantis FLO P-03 (M).....23
34596	Atlantis FLO P-04 (L).....23
34597	Atlantis FLO P-05 (XL).....23
34598	Atlantis FLO P-06 Profile 4.2.....55
34599	Atlantis FLO P-07 Profile 4.8.....55
34601	Atlantis FLO Screwdriver.....44
35243	Atlantis IO FLO IO P-01 (XS).....23
35244	Atlantis IO FLO IO P-02 (S).....23
35245	Atlantis IO FLO IO P-03 (M).....23
35246	Atlantis IO FLO IO P-04 (L).....23
35247	Atlantis IO FLO IO P-05 (XL).....23
35248	Atlantis IO FLO IO P-06 Profile 4.2.....55
35249	Atlantis IO FLO IO P-07 Profile 4.8.....55
36030	Atlantis screwdriver-ASA 18mm.....42
36031	Atlantis screwdriver-ASA 24mm.....42
36032	Atlantis screwdriver-ASA 32mm.....42
68010001	Cover Screw EV (XS).....6, 16
68010002	Cover Screw EV (S).....8, 16
68010005	Cover Screw EV (M).....10, 16
68010006	Cover Screw EV (L).....12, 16
68010007	Cover Screw EV (XL).....14, 16
68010013	TempBase Cap (XS) (S) (M).....6, 8, 10, 20
68010014	TempBase Cap (L).....12, 20
68010015	TempBase Cap (XL).....14, 20
68012001	TiDesign EV (XS) Ø4.0 1.5mm.....6, 25
68012002	TiDesign EV (XS) Ø4.0 2.5mm.....6, 25
68012003	TiDesign EV (XS) Ø4.0 3.5mm.....6, 25
68012004	TiDesign EV (XS) Ø4.0 4.5mm.....6, 25
68012005	TiDesign EV (XS) Ø4.0 1.5mm 15°.....6, 25
68012006	TiDesign EV (XS) Ø4.0 2.5mm 15°.....6, 25
68012007	TiDesign EV (XS) Ø4.0 3.5mm 15°.....6, 25
68012008	TiDesign EV (XS) Ø4.0 4.5mm 15°.....6, 25
68012009	TiDesign EV (S) Ø4.5 1.5mm.....8, 25
68012010	TiDesign EV (S) Ø4.5 2.5mm.....8, 25
68012011	TiDesign EV (S) Ø4.5 3.5mm.....8, 25
68012012	TiDesign EV (S) Ø4.5 4.5mm.....8, 25
68012017	TiDesign EV (S) Ø4.5 1.5mm 15°.....8, 25
68012018	TiDesign EV (S) Ø4.5 2.5mm 15°.....8, 25
68012019	TiDesign EV (S) Ø4.5 3.5mm 15°.....8, 25
68012020	TiDesign EV (S) Ø4.5 4.5mm 15°.....8, 25
68012025	TiDesign EV (S) Ø5.5 1.5mm Tri.....8, 25
68012042	TiDesign EV (M) Ø5.5 1.5mm.....10, 26
68012043	TiDesign EV (M) Ø5.5 2.5mm.....10, 26
68012044	TiDesign EV (M) Ø5.5 3.5mm.....10, 26
68012045	TiDesign EV (M) Ø5.5 4.5mm.....10, 26
68012046	TiDesign EV (M) Ø5.5 1.5mm 15°.....10, 26
68012047	TiDesign EV (M) Ø5.5 2.5mm 15°.....10, 26
68012048	TiDesign EV (M) Ø5.5 3.5mm 15°.....10, 26
68012049	TiDesign EV (M) Ø5.5 4.5mm 15°.....10, 26
68012050	TiDesign EV (M) Ø5.5 1.5mm Tri.....10, 26
68012051	TiDesign EV (M) Ø7.0 1.5mm Tri.....10, 26
68012052	TiDesign EV (L) Ø7.0 1.5mm.....12, 26
68012053	TiDesign EV (L) Ø7.0 2.5mm.....12, 26

Order No.	page	Order No.	page
68012054	TiDesign EV (L) Ø7.0 3.5mm.....12, 26	68012211	MultiBase Abutment EV (L) 2.5mm NI.....12, 31, 50
68012055	TiDesign EV (L) Ø7.0 4.5mm.....12, 26	68012212	MultiBase Abutment EV (L) 3.5mm NI.....12, 31, 50
68012056	TiDesign EV (L) Ø5.5 1.5mm 15°.....12, 26	68012213	MultiBase Abutment EV (L) 4.5mm NI.....12, 31, 50
68012057	TiDesign EV (L) Ø5.5 2.5mm 15°.....12, 26	68012214	MultiBase Abutment EV (L) 1.5mm 17°.....12, 31
68012058	TiDesign EV (L) Ø5.5 3.5mm 15°.....12, 26	68012215	MultiBase Abutment EV (L) 2.5mm 17°.....12, 31
68012059	TiDesign EV (L) Ø5.5 4.5mm 15°.....12, 26	68012216	MultiBase Abutment EV (L) 3.5mm 17°.....12, 31
68012060	TiDesign EV (L) Ø5.5 1.5mm Tri.....12, 26	68012217	MultiBase Abutment EV (L) 4.5mm 17°.....12, 31
68012061	TiDesign EV (L) Ø7.0 1.5mm Tri.....12, 26	68012218	MultiBase Abutment EV (L) 1.5mm 17° NI.....12, 31, 50
68012062	TiDesign EV (XL) Ø7.0 1.5mm.....14, 27	68012219	MultiBase Abutment EV (L) 2.5mm 17° NI.....12, 31, 50
68012063	TiDesign EV (XL) Ø7.0 2.5mm.....14, 27	68012220	MultiBase Abutment EV (L) 3.5mm 17° NI.....12, 31, 50
68012064	TiDesign EV (XL) Ø7.0 1.5mm 15°.....14, 27	68012221	MultiBase Abutment EV (L) 1.5mm 30°.....12, 31
68012065	TiDesign EV (XL) Ø7.0 2.5mm 15°.....14, 27	68012222	MultiBase Abutment EV (L) 2.5mm 30°.....12, 31
68012077	CastDesign EV (S).....9, 27	68012223	MultiBase Abutment EV (L) 1.5mm 30° NI.....12, 31, 50
68012078	CastDesign EV (M).....11, 27	68012224	MultiBase Abutment EV (L) 2.5mm 30° NI.....12, 31, 50
68012079	CastDesign EV (L).....13, 27	68012225	MultiBase Abutment EV (XL) 1.5mm NI.....14, 31
68012080	CastDesign EV (XL).....15, 27	68012226	MultiBase Abutment EV (L) 2.5mm NI.....14, 31
68012081	TitaniumBase EV (XS) 1mm.....7, 28	68012227	MultiBase Abutment EV (XL) 3.5mm NI.....14, 31
68012082	TitaniumBase EV (XS) 2mm.....7, 28	68012228	MultiBase Abutment EV (XL) 4.5mm NI.....14, 31
68012083	TitaniumBase EV (S) 1mm.....9, 28	68012229	MultiBase Abutment Head with holder.....32
68012084	TitaniumBase EV (S) 2mm.....9, 28	68012230	MultiBase Heal Cap Ø5.4 4mm.....6, 8, 10, 12, 14, 32, 48, 50
68012088	TitaniumBase EV (M) 1mm.....11, 28	68012231	MultiBase Transfer.....6, 8, 10, 12, 14, 32, 48, 50
68012089	TitaniumBase EV (M) 2mm.....11, 28	68012232	MultiBase Pick-Up.....6, 8, 10, 12, 14, 32, 48, 50
68012090	TitaniumBase EV (L) 1mm.....13, 28	68012233	MultiBase Bridge Screw.....6, 8, 10, 12, 14, 34, 48, 50
68012091	TitaniumBase EV (L) 2mm.....13, 28	68012234	MultiBase Lab Abutment Pin 14mm.....6, 8, 10, 12, 14, 34, 48, 50
68012092	TitaniumBase EV (XL) 1mm.....15, 28	68012235	MultiBase Lab Abutment Pin 18mm.....6, 8, 10, 12, 14, 34, 48, 50
68012093	TitaniumBase EV (XL) 2mm.....15, 28	68012236	MultiBase Lab Abutment Pin 22mm.....6, 8, 10, 12, 14, 34, 48, 50
68012166	Abutment Screw EV (XS).....20, 53	68012237	MultiBase Lab Bridge Screw 4 pcs.....6, 8, 10, 12, 14, 34, 48, 50
68012167	Abutment Screw EV (S).....20, 53	68012238	MultiBase Analog.....6, 8, 10, 12, 14, 34, 48, 50
68012168	Abutment Screw EV (M).....20, 53	68012239	MultiBase Temporary Cylinder.....6, 8, 10, 12, 14, 33, 48, 50
68012169	Abutment Screw EV (L).....20, 53	68012240	MultiBase Burnout Cylinder.....6, 8, 10, 12, 14, 33, 48, 50
68012170	Abutment Screw EV (XL).....20, 53	68012241	Protection sleeve.....33
68012171	MultiBase Abutment EV (XS) 1.5mm NI.....6, 29	68012243	MultiBase Semi-Burnout Cylinder.....6, 8, 10, 12, 14, 33, 48, 50
68012172	MultiBase Abutment EV (XS) 2.5mm NI.....6, 29	68012244	MultiBase Driver.....43
68012173	MultiBase Abutment EV (XS) 3.5mm NI.....6, 29	68012352	MultiBase Abutment EV (L) 4.5mm 17° NI.....12, 31, 50
68012174	MultiBase Abutment EV (S) 1.5mm NI.....8, 29	68012414	LOCATOR R-Tx* Abutment EV (S) 1mm.....8, 35
68012175	MultiBase Abutment EV (S) 2.5mm NI.....8, 29	68012415	LOCATOR R-Tx* Abutment EV (S) 2mm.....8, 35
68012176	MultiBase Abutment EV (S) 3.5mm NI.....8, 29	68012416	LOCATOR R-Tx* Abutment EV (S) 3mm.....8, 35
68012177	MultiBase Abutment EV (S) 4.5mm NI.....8, 29	68012417	LOCATOR R-Tx* Abutment EV (S) 4mm.....8, 35
68012178	MultiBase Abutment EV (S) 1.5mm 17°.....8, 29	68012418	LOCATOR R-Tx* Abutment EV (S) 5mm.....8, 35
68012179	MultiBase Abutment EV (S) 2.5mm 17°.....8, 29	68012419	LOCATOR R-Tx* Abutment EV (S) 6mm.....8, 35
68012180	MultiBase Abutment EV (S) 3.5mm 17°.....8, 29	68012420	LOCATOR R-Tx* Abutment EV (M) 1mm.....10, 35, 48
68012181	MultiBase Abutment EV (S) 4.5mm 17°.....8, 29	68012421	LOCATOR R-Tx* Abutment EV (M) 2mm.....10, 35, 48
68012182	MultiBase Abutment EV (S) 1.5mm 17° NI.....8, 29	68012422	LOCATOR R-Tx* Abutment EV (M) 3mm.....10, 35, 48
68012183	MultiBase Abutment EV (S) 2.5mm 17° NI.....8, 29	68012423	LOCATOR R-Tx* Abutment EV (M) 4mm.....10, 35, 48
68012184	MultiBase Abutment EV (S) 3.5mm 17° NI.....8, 29	68012424	LOCATOR R-Tx* Abutment EV (M) 5mm.....10, 35, 48
68012185	MultiBase Abutment EV (S) 4.5mm 17° NI.....8, 29	68012425	LOCATOR R-Tx* Abutment EV (M) 6mm.....10, 35, 48
68012186	MultiBase Abutment EV (S) 1.5mm 30°.....8, 29	68012426	LOCATOR R-Tx* Abutment EV (L) 1mm.....12, 35, 50
68012187	MultiBase Abutment EV (S) 2.5mm 30°.....8, 29	68012427	LOCATOR R-Tx* Abutment EV (L) 2mm.....12, 35, 50
68012190	MultiBase Abutment EV (S) 1.5mm 30° NI.....8, 29	68012428	LOCATOR R-Tx* Abutment EV (L) 3mm.....12, 35, 50
68012191	MultiBase Abutment EV (S) 2.5mm 30° NI.....8, 29	68012429	LOCATOR R-Tx* Abutment EV (L) 4mm.....12, 35, 50
68012194	MultiBase Abutment EV (M) 1.5mm NI.....10, 30, 48	68012430	LOCATOR R-Tx* Abutment EV (L) 5mm.....12, 35, 50
68012195	MultiBase Abutment EV (M) 2.5mm NI.....10, 30, 48	68012431	LOCATOR R-Tx* Abutment EV (L) 6mm.....12, 35, 50
68012196	MultiBase Abutment EV (M) 3.5mm NI.....10, 30, 48	68012432	LOCATOR R-Tx* Zero Retention Insert Grey 4 pcs .....9, 11, 13, 36, 49, 51
68012197	MultiBase Abutment EV (M) 4.5mm NI.....10, 30, 48	68012433	LOCATOR R-Tx* Low Retention Insert Blue 4 pcs .....9, 11, 13, 36, 49, 51
68012198	MultiBase Abutment EV (M) 1.5mm 17°.....10, 30	68012434	LOCATOR R-Tx* Medium Retention Insert Pink 4 pcs .....9, 11, 13, 36, 49, 51
68012199	MultiBase Abutment EV (M) 2.5mm 17°.....10, 30	68012435	LOCATOR R-Tx* High Retention Insert Clear 4 pcs .....9, 11, 13, 36, 49, 51
68012200	MultiBase Abutment EV (M) 3.5mm 17°.....10, 30	68012436	LOCATOR R-Tx* Low Retention Limited Range Insert Aqua 4 pcs.....9, 11, 13, 36, 49, 51
68012201	MultiBase Abutment EV (M) 4.5mm 17°.....10, 30	68012437	LOCATOR R-Tx* Medium Retention Limited Range Insert Magenta 4 pcs.....9, 11, 13, 36, 49, 51
68012202	MultiBase Abutment EV (M) 1.5mm 17° NI.....10, 30, 48	68012438	LOCATOR R-Tx* High Retention Limited Range Insert Gold 4 pcs.....9, 11, 13, 36, 49, 51
68012203	MultiBase Abutment EV (M) 2.5mm 17° NI.....10, 30, 48	68012439	LOCATOR R-Tx* Mixed Retention
68012204	MultiBase Abutment EV (M) 3.5mm 17° NI.....10, 30, 48		
68012205	MultiBase Abutment EV (M) 4.5mm 17° NI.....10, 30, 48		
68012206	MultiBase Abutment EV (M) 1.5mm 30°.....10, 30		
68012207	MultiBase Abutment EV (M) 2.5mm 30°.....10, 30		
68012208	MultiBase Abutment EV (M) 1.5mm 30° NI.....10, 30, 48		
68012209	MultiBase Abutment EV (M) 2.5mm 30° NI.....10, 30, 48		
68012210	MultiBase Abutment EV (L) 1.5mm NI.....12, 31, 50		

Order No.	page
	Limited Range Processing Pack 2 pcs..... 9, 11, 13, 36, 49, 51
68012440	LOCATOR R-Tx® Processing Insert 4 pcs..... 9, 11, 13, 37, 49, 51
68012441	LOCATOR R-Tx® Block-Out Spacer 20 pcs... 9, 11, 13, 37, 49, 51
68012442	LOCATOR R-Tx® Denture Attachment Processing Assembly 4 pcs..... 9, 11, 13, 36, 49, 51
68012443	LOCATOR R-Tx® Abutment Analog Ø4 4 pcs ..... 8, 10, 12, 35, 48, 50
68012444	LOCATOR R-Tx® Impression Coping 4 pcs... 8, 10, 12, 38, 48, 50
68012445	LOCATOR R-Tx® Processing Spacer 4 pcs... 9, 11, 13, 37, 49, 51
68012446	LOCATOR R-Tx® Retention Insert Tool .....38
68013001	HealDesign EV (XS) Ø3.5 2.5mm.....6, 16
68013002	HealDesign EV (XS) Ø3.5 3.5mm.....6, 16
68013003	HealDesign EV (XS) Ø3.5 4.5mm.....6, 16
68013004	HealDesign EV (XS) Ø3.5 6.5mm.....6, 16
68013005	HealDesign EV (S) Ø4.0 2.5mm .....8, 16
68013006	HealDesign EV (S) Ø4.0 3.5mm .....8, 16
68013007	HealDesign EV (S) Ø4.0 4.5mm .....8, 16
68013008	HealDesign EV (S) Ø4.0 6.5mm .....8, 16
68013009	HealDesign EV (S) Ø5.0 2.5mm .....8, 16
68013010	HealDesign EV (S) Ø5.0 3.5mm .....8, 16
68013011	HealDesign EV (S) Ø5.0 4.5mm .....8, 16
68013012	HealDesign EV (S) Ø5.0 6.5mm .....8, 16
68013013	HealDesign EV (S) Ø6.0 3.5mm .....8, 16
68013014	HealDesign EV (S) Ø6.0 4.5mm .....8, 16
68013015	HealDesign EV (M) Ø5.0 2.5mm.....10, 17, 48
68013016	HealDesign EV (M) Ø5.0 3.5mm.....10, 17, 48
68013017	HealDesign EV (M) Ø5.0 4.5mm.....10, 17, 48
68013018	HealDesign EV (M) Ø5.0 6.5mm.....10, 17, 48
68013019	HealDesign EV (M) Ø6.5 2.5mm.....10, 17, 48
68013020	HealDesign EV (M) Ø6.5 3.5mm.....10, 17, 48
68013021	HealDesign EV (M) Ø6.5 4.5mm.....10, 17, 48
68013022	HealDesign EV (M) Ø6.5 6.5mm.....10, 17, 48
68013023	HealDesign EV (L) Ø5.0 2.5mm.....12, 17, 50
68013024	HealDesign EV (L) Ø5.0 3.5mm.....12, 17, 50
68013025	HealDesign EV (L) Ø5.0 4.5mm.....12, 17, 50
68013026	HealDesign EV (L) Ø5.0 6.5mm.....12, 17, 50
68013027	HealDesign EV (L) Ø6.5 2.5mm.....12, 17, 50
68013028	HealDesign EV (L) Ø6.5 3.5mm.....12, 17, 50
68013029	HealDesign EV (L) Ø6.5 4.5mm.....12, 17, 50
68013030	HealDesign EV (L) Ø6.5 6.5mm.....12, 17, 50
68013031	HealDesign EV (L) Ø7.5 3.5mm.....12, 17, 50
68013032	HealDesign EV (L) Ø7.5 4.5mm.....12, 17, 50
68013033	HealDesign EV (XL) Ø6.5 2.5mm.....14, 17
68013034	HealDesign EV (XL) Ø6.5 3.5mm.....14, 17
68013035	HealDesign EV (XL) Ø6.5 4.5mm.....14, 17
68013036	HealDesign EV (XL) Ø6.5 6.5mm.....14, 17
68013037	HealDesign EV (XL) Ø7.5 3.5mm.....14, 17
68013038	HealDesign EV (XL) Ø7.5 4.5mm.....14, 17
68013039	HealDesign EV (S) Ø5.0 3.5mm Tri .....8, 16
68013040	HealDesign EV (M) Ø5.0 3.5mm Tri .....10, 17
68013041	HealDesign EV (M) Ø6.5 3.5mm Tri .....10, 17
68013042	HealDesign EV (L) Ø5.0 3.5mm Tri .....12, 17
68013043	HealDesign EV (L) Ø6.5 3.5mm Tri .....12, 17
68013044	Healing Abutment EV (XS) 2mm.....6, 18
68013045	Healing Abutment EV (XS) 3mm.....6, 18
68013046	Healing Abutment EV (XS) 4mm.....6, 18
68013047	Healing Abutment EV (XS) 6mm.....6, 18
68013048	Healing Abutment EV (S) 2mm.....8, 18

Order No.	page
68013049	Healing Abutment EV (S) 3mm.....8, 18
68013050	Healing Abutment EV (S) 4mm.....8, 18
68013051	Healing Abutment EV (S) 6mm.....8, 18
68013052	Healing Abutment EV (M) 2mm.....10, 18, 48
68013053	Healing Abutment EV (M) 3mm.....10, 18, 48
68013054	Healing Abutment EV (M) 4mm.....10, 18, 48
68013055	Healing Abutment EV (M) 6mm.....10, 18, 48
68013056	Healing Abutment EV (L) 2mm.....12, 18, 50
68013057	Healing Abutment EV (L) 3mm.....12, 18, 50
68013058	Healing Abutment EV (L) 4mm.....12, 18, 50
68013059	Healing Abutment EV (L) 6mm.....12, 18, 50
68013060	Healing Abutment EV (XL) 2mm.....14, 18
68013061	Healing Abutment EV (XL) 3mm.....14, 18
68013062	Healing Abutment EV (XL) 4mm.....14, 18
68013063	Healing Abutment EV (XL) 6mm.....14, 18
68013064	TempAbutment EV (XS).....19
68013066	TempAbutment EV (S).....19
68013070	TempAbutment EV (M).....19
68013072	TempAbutment EV (L).....19
68013074	TempAbutment EV (XL).....19
68014009	Implant Pick-Up EV Design (S) short.....9, 21
68014010	Implant Pick-Up EV Design (M) short.....11, 21
68014011	Implant Pick-Up EV Design (L) short.....13, 21
68014012	Implant Pick-Up EV Design (XL) short.....15, 21
68014013	Implant Pick-Up EV Design (XS) long .....7, 21
68014014	Implant Pick-Up EV Design (S) long .....9, 21
68014015	Implant Pick-Up EV Design (M) long .....11, 21
68014016	Implant Pick-Up EV Design (L) long .....13, 21
68014017	Implant Pick-Up EV Design (XL) long .....15, 21
68014018	Implant Transfer EV (S) short.....9, 22
68014019	Implant Transfer EV (M) short.....11, 22
68014020	Implant Transfer EV (L) short.....13, 22
68014021	Implant Transfer EV (XL) short.....15, 22
68014022	Implant Transfer EV (XS) long .....7, 22
68014023	Implant Transfer EV (S) long .....9, 22
68014024	Implant Transfer EV (M) long .....11, 22
68014025	Implant Transfer EV (L) long .....13, 22
68014026	Implant Transfer EV (XL) long .....15, 22
68014029	Lab Abutment Screw EV (XS) 4 pcs .....7, 24, 56
68014030	Lab Abutment Screw EV (S) 4 pcs .....9, 24, 56
68014031	Lab Abutment Screw EV (M) 4 pcs .....11, 24, 49, 56
68014032	Lab Abutment Screw EV (L) 4 pcs .....13, 24, 51, 56
68014033	Lab Abutment Screw EV (XL) 4 pcs .....15, 24, 56
68014034	Implant Analog EV (XS).....7, 24
68014035	Implant Analog EV (S) .....9, 24
68014036	Implant Analog EV (M) .....11, 24
68014037	Implant Analog EV (L) .....13, 24
68014038	Implant Analog EV (XL) .....15, 24
68015205	Hex Driver 24mm.....42
68015206	Hex Driver 35mm.....42
68015207	Hex Driver 20mm.....42
68015288	Prosthetic Tray.....45
68020018	Atlantis IO FLO-S A04K (XS).....23
68020019	Atlantis IO FLO-S A04L (S).....23
68020020	Atlantis IO FLO-S A04M (M) .....23, 55
68020021	Atlantis IO FLO-S A04N (L).....23, 55
68020022	Atlantis IO FLO-S A04O (XL) .....23
68020034	Atlantis IO FLO-S A04S, MultiBase Abutment EV .....23, 55



# Index

## Alphabetical order

Order No.		page
68012169	Abutment Screw EV (L) .....	20, 53
68012168	Abutment Screw EV (M) .....	20, 53
68012167	Abutment Screw EV (S) .....	20, 53
68012170	Abutment Screw EV (XL) .....	20, 53
68012166	Abutment Screw EV (XS) .....	20, 53
34593	Atlantis FLO P-01 (XS) .....	23
34594	Atlantis FLO P-02 (S) .....	23
34595	Atlantis FLO P-03 (M) .....	23
34596	Atlantis FLO P-04 (L) .....	23
34597	Atlantis FLO P-05 (XL) .....	23
34598	Atlantis FLO P-06 Profile 4.2 .....	55
34599	Atlantis FLO P-07 Profile 4.8 .....	55
34601	Atlantis FLO Screwdriver .....	45
35243	Atlantis IO FLO IO P-01 (XS) .....	23
35244	Atlantis IO FLO IO P-02 (S) .....	23
35245	Atlantis IO FLO IO P-03 (M) .....	23
35246	Atlantis IO FLO IO P-04 (L) .....	23
35247	Atlantis IO FLO IO P-05 (XL) .....	23
35248	Atlantis IO FLO IO P-06 Profile 4.2 .....	55
35249	Atlantis IO FLO IO P-07 Profile 4.8 .....	55
68020018	Atlantis IO FLO-S A04K (XS) .....	23
68020019	Atlantis IO FLO-S A04L (S) .....	23
68020020	Atlantis IO FLO-S A04M (M) .....	23, 55
68020021	Atlantis IO FLO-S A04N (L) .....	23, 55
68020022	Atlantis IO FLO-S A04O (XL) .....	23
68020034	Atlantis IO FLO-S A04S, MultiBase Abutment EV .....	23, 55
36030	Atlantis screwdriver-ASA 18mm .....	42
36031	Atlantis screwdriver-ASA 24mm .....	42
36032	Atlantis screwdriver-ASA 32mm .....	42
68012079	CastDesign EV (L) .....	13, 27
68012078	CastDesign EV (M) .....	11, 27
68012077	CastDesign EV (S) .....	9, 27
68012080	CastDesign EV (XL) .....	15, 27
26115	Conometric Abutment EV 3.6 0° Ø3.3 1mm NI .....	8, 39
26116	Conometric Abutment EV 3.6 0° Ø3.3 2mm NI .....	8, 39
26117	Conometric Abutment EV 3.6 0° Ø3.3 3mm NI .....	8, 39
26121	Conometric Abutment EV 3.6 0° Ø4.5 1mm .....	8, 39
26122	Conometric Abutment EV 3.6 0° Ø4.5 2mm .....	8, 39
26123	Conometric Abutment EV 3.6 0° Ø4.5 3mm .....	8, 39
26127	Conometric Abutment EV 3.6 15° Ø4.5 1mm .....	8, 39
26128	Conometric Abutment EV 3.6 15° Ø4.5 2mm .....	8, 39
26129	Conometric Abutment EV 3.6 15° Ø4.5 3mm .....	8, 39
26124	Conometric Abutment EV 4.2 0° Ø4.5 1mm .....	10, 39
26125	Conometric Abutment EV 4.2 0° Ø4.5 2mm .....	10, 39
26126	Conometric Abutment EV 4.2 0° Ø4.5 3mm .....	10, 39
26130	Conometric Abutment EV 4.2 15° Ø4.5 1mm .....	10, 39
26131	Conometric Abutment EV 4.2 15° Ø4.5 2mm .....	10, 39
26132	Conometric Abutment EV 4.2 15° Ø4.5 3mm .....	10, 39
31047210	Conometric Analog Ø3.3 .....	9, 11, 41
31072020	Conometric Analog Ø4.5 .....	9, 11, 41
31072910	Conometric Abutment Driver Ø3.3 20mm .....	43
31072909	Conometric Abutment Driver Ø3.3 25mm .....	43
31072301	Conometric Final Cap Ø3.3 .....	9, 11, 41
31072303	Conometric Final Cap Ø4.5 .....	9, 11, 41
31072911	Conometric Fixation Tool .....	44
31072908	Conometric Fixation Tool Tip Concave (5 pcs) .....	44
31072906	Conometric Fixation Tool Tip Convex (5 pcs) .....	44
31072907	Conometric Fixation Tool Tip U-shape (5 pcs) .....	44
31072101	Conometric Healing Cap Ø3.3/4.8 .....	9, 11, 40
31072102	Conometric Healing Cap Ø3.3/6.0 .....	9, 11, 40
31072103	Conometric Healing Cap Ø4.5/6.0 .....	9, 11, 40
31072001	Conometric Impression Cap Ø3.3/5.4 .....	9, 11, 40
31072002	Conometric Impression Cap Ø4.5/5.4 .....	9, 11, 40
31072121	Conometric Lab Cap Ø3.3/4.6 .....	9, 11, 41
31072123	Conometric Lab Cap Ø4.5/5.8 .....	9, 11, 41
31072112	Conometric Temporization Cap Ø3.3/4.6 .....	8, 10, 40
31072114	Conometric Temporization Cap Ø4.5/5.8 .....	8, 10, 40

Order No.		page
31033636	Conometric Temporization Cap Insertion Tool Ø3.3 .....	44
31033637	Conometric Temporization Cap Insertion Tool Ø4.5 .....	44
68010006	Cover Screw EV (L) .....	12, 16
68010005	Cover Screw EV (M) .....	10, 16
68010002	Cover Screw EV (S) .....	8, 16
68010007	Cover Screw EV (XL) .....	14, 16
68010001	Cover Screw EV (XS) .....	6, 16
25582	Cover Screw Profile 4.2 .....	48, 52
25583	Cover Screw Profile 4.8 .....	50, 52
68013015	HealDesign EV (M) Ø5.0 2.5mm .....	10, 17, 48
68013016	HealDesign EV (M) Ø5.0 3.5mm .....	10, 17, 48
68013040	HealDesign EV (M) Ø5.0 3.5mm Tri .....	10, 17
68013017	HealDesign EV (M) Ø5.0 4.5mm .....	10, 17, 48
68013018	HealDesign EV (M) Ø5.0 6.5mm .....	10, 17, 48
68013019	HealDesign EV (M) Ø6.5 2.5mm .....	10, 17, 48
68013020	HealDesign EV (M) Ø6.5 3.5mm .....	10, 17, 48
68013041	HealDesign EV (M) Ø6.5 3.5mm Tri .....	10, 17
68013021	HealDesign EV (M) Ø6.5 4.5mm .....	10, 17, 48
68013022	HealDesign EV (M) Ø6.5 6.5mm .....	10, 17, 48
68013023	HealDesign EV (L) Ø5.0 2.5mm .....	12, 17, 50
68013024	HealDesign EV (L) Ø5.0 3.5mm .....	12, 17, 50
68013042	HealDesign EV (L) Ø5.0 3.5mm Tri .....	12, 17
68013025	HealDesign EV (L) Ø5.0 4.5mm .....	12, 17, 50
68013026	HealDesign EV (L) Ø5.0 6.5mm .....	12, 17, 50
68013027	HealDesign EV (L) Ø6.5 2.5mm .....	12, 17, 50
68013028	HealDesign EV (L) Ø6.5 3.5mm .....	12, 17, 50
68013043	HealDesign EV (L) Ø6.5 3.5mm Tri .....	12, 17
68013029	HealDesign EV (L) Ø6.5 4.5mm .....	12, 17, 50
68013030	HealDesign EV (L) Ø6.5 6.5mm .....	12, 17, 50
68013031	HealDesign EV (L) Ø7.5 3.5mm .....	12, 17, 50
68013032	HealDesign EV (L) Ø7.5 4.5mm .....	12, 17, 50
68013005	HealDesign EV (S) Ø4.0 2.5mm .....	8, 16
68013006	HealDesign EV (S) Ø4.0 3.5mm .....	8, 16
68013007	HealDesign EV (S) Ø4.0 4.5mm .....	8, 16
68013008	HealDesign EV (S) Ø4.0 6.5mm .....	8, 16
68013009	HealDesign EV (S) Ø5.0 2.5mm .....	8, 16
68013010	HealDesign EV (S) Ø5.0 3.5mm .....	8, 16
68013039	HealDesign EV (S) Ø5.0 3.5mm Tri .....	8, 16
68013011	HealDesign EV (S) Ø5.0 4.5mm .....	8, 16
68013012	HealDesign EV (S) Ø5.0 6.5mm .....	8, 16
68013013	HealDesign EV (S) Ø6.0 3.5mm .....	8, 16
68013014	HealDesign EV (S) Ø6.0 4.5mm .....	8, 16
68013033	HealDesign EV (XL) Ø6.5 2.5mm .....	14, 17
68013034	HealDesign EV (XL) Ø6.5 3.5mm .....	14, 17
68013035	HealDesign EV (XL) Ø6.5 4.5mm .....	14, 17
68013036	HealDesign EV (XL) Ø6.5 6.5mm .....	14, 17
68013037	HealDesign EV (XL) Ø7.5 3.5mm .....	14, 17
68013038	HealDesign EV (XL) Ø7.5 4.5mm .....	14, 17
68013001	HealDesign EV (XS) Ø3.5 2.5mm .....	6, 16
68013002	HealDesign EV (XS) Ø3.5 3.5mm .....	6, 16
68013003	HealDesign EV (XS) Ø3.5 4.5mm .....	6, 16
68013004	HealDesign EV (XS) Ø3.5 6.5mm .....	6, 16
25585	HealDesign Profile EV 4.2 Ø5 4.5mm .....	48, 52
25584	HealDesign Profile EV 4.2 Ø5 5mm .....	48, 52
25587	HealDesign Profile EV 4.2 Ø5 4mm .....	48, 52
25586	HealDesign Profile EV 4.2 Ø6.5 4mm .....	48, 52
25588	HealDesign Profile EV 4.8 Ø5 4.5mm .....	50, 52
25591	HealDesign Profile EV 4.8 Ø5 4.5mm .....	50, 52
25590	HealDesign Profile EV 4.8 Ø6.5 4.5mm .....	50, 52
25589	HealDesign Profile EV 4.8 Ø6.5 5.5mm .....	50, 52
68013056	Healing Abutment EV (L) 2mm .....	12, 18, 50
68013057	Healing Abutment EV (L) 3mm .....	12, 18, 50
68013058	Healing Abutment EV (L) 4mm .....	12, 18, 50
68013059	Healing Abutment EV (L) 6mm .....	12, 18, 50
68013052	Healing Abutment EV (M) 2mm .....	10, 18, 48
68013053	Healing Abutment EV (M) 3mm .....	10, 18, 48
68013054	Healing Abutment EV (M) 4mm .....	10, 18, 48

Order No.	page
68013055	Healing Abutment EV (M) 6mm.....10, 18, 48
68013048	Healing Abutment EV (S) 2mm.....8, 18
68013049	Healing Abutment EV (S) 3mm.....8, 18
68013050	Healing Abutment EV (S) 4mm.....8, 18
68013051	Healing Abutment EV (S) 6mm.....8, 18
68013060	Healing Abutment EV (XL) 2mm.....14, 18
68013061	Healing Abutment EV (XL) 3mm.....14, 18
68013062	Healing Abutment EV (XL) 4mm.....14, 18
68013063	Healing Abutment EV (XL) 6mm.....14, 18
68013044	Healing Abutment EV (XS) 2mm.....6, 18
68013045	Healing Abutment EV (XS) 3mm.....6, 18
68013046	Healing Abutment EV (XS) 4mm.....6, 18
68013047	Healing Abutment EV (XS) 6mm.....6, 18
68015207	Hex Driver 20mm.....42
25771	Hex Driver 20mm manual.....42
68015205	Hex Driver 24mm.....42
25772	Hex Driver 31mm manual.....42
68015206	Hex Driver 35mm.....42
68014037	Implant Analog EV (L).....13, 24
68014036	Implant Analog EV (M).....11, 24
68014035	Implant Analog EV (S).....9, 24
68014038	Implant Analog EV (XL).....15, 24
68014034	Implant Analog EV (XS).....7, 24
26262	Implant Pick-Up Design Profile EV 4.2.....49, 54
26263	Implant Pick-Up Design Profile EV 4.8.....51, 54
68014016	Implant Pick-Up EV Design (L) long.....21
68014011	Implant Pick-Up EV Design (L) short.....21
68014015	Implant Pick-Up EV Design (M) long.....21
68014010	Implant Pick-Up EV Design (M) short.....21
68014014	Implant Pick-Up EV Design (S) long.....9, 21
68014009	Implant Pick-Up EV Design (S) short.....9, 21
68014017	Implant Pick-Up EV Design (XL) long.....21
68014012	Implant Pick-Up EV Design (XL) short.....21
68014013	Implant Pick-Up EV Design (XS) long.....21
26258	Implant Pick-Up Profile EV 4.2 short.....49, 54
26259	Implant Pick-Up Profile EV 4.8 short.....51, 54
25610	Implant Replica Profile EV 4.2.....49, 54
25611	Implant Replica Profile EV 4.8.....51, 54
68014025	Implant Transfer EV (L) long.....13, 22
68014020	Implant Transfer EV (L) short.....13, 22
68014024	Implant Transfer EV (M) long.....11, 22
68014019	Implant Transfer EV (M) short.....11, 22
68014023	Implant Transfer EV (S) long.....9, 22
68014018	Implant Transfer EV (S) short.....9, 22
68014026	Implant Transfer EV (XL) long.....15, 22
68014021	Implant Transfer EV (XL) short.....15, 22
68014022	Implant Transfer EV (XS) long.....7, 22
25607	Implant Transfer Profile EV 4.2 long.....49, 54
25606	Implant Transfer Profile EV 4.2 short.....49, 54
25609	Implant Transfer Profile EV 4.8 long.....51, 54
25608	Implant Transfer Profile EV 4.8 short.....51, 54
68014032	Lab Abutment Screw EV (L) 4 pcs.....13, 24, 51, 56
68014031	Lab Abutment Screw EV (M) 4 pcs.....11, 24, 49, 56
68014030	Lab Abutment Screw EV (S) 4 pcs.....9, 24, 56
68014033	Lab Abutment Screw EV (XL) 4 pcs.....15, 24, 56
68014029	Lab Abutment Screw EV (XS) 4 pcs.....7, 24, 56
68012443	LOCATOR R-Tx® Abutment Analog Ø4 4 pcs .....8, 10, 12, 35, 48, 50
68012426	LOCATOR R-Tx® Abutment EV (L) 1mm.....12, 35, 50
68012427	LOCATOR R-Tx® Abutment EV (L) 2mm.....12, 35, 50
68012428	LOCATOR R-Tx® Abutment EV (L) 3mm.....12, 35, 50
68012429	LOCATOR R-Tx® Abutment EV (L) 4mm.....12, 35, 50
68012430	LOCATOR R-Tx® Abutment EV (L) 5mm.....12, 35, 50
68012431	LOCATOR R-Tx® Abutment EV (L) 6mm.....12, 35, 50
68012420	LOCATOR R-Tx® Abutment EV (M) 1mm.....10, 35, 48
68012421	LOCATOR R-Tx® Abutment EV (M) 2mm.....10, 35, 48
68012422	LOCATOR R-Tx® Abutment EV (M) 3mm.....10, 35, 48

Order No.	page
68012423	LOCATOR R-Tx® Abutment EV (M) 4mm.....10, 35, 48
68012424	LOCATOR R-Tx® Abutment EV (M) 5mm.....10, 35, 48
68012425	LOCATOR R-Tx® Abutment EV (M) 6mm.....10, 35, 48
68012414	LOCATOR R-Tx® Abutment EV (S) 1mm.....8, 35
68012415	LOCATOR R-Tx® Abutment EV (S) 2mm.....8, 35
68012416	LOCATOR R-Tx® Abutment EV (S) 3mm.....8, 35
68012417	LOCATOR R-Tx® Abutment EV (S) 4mm.....8, 35
68012418	LOCATOR R-Tx® Abutment EV (S) 5mm.....8, 35
68012419	LOCATOR R-Tx® Abutment EV (S) 6mm.....8, 35
68012441	LOCATOR R-Tx® Block-Out Spacer 20 pcs... 9, 11, 13, 37, 49, 51
68012442	LOCATOR R-Tx® Denture Attachment Processing Assembly 4 pcs..... 9, 11, 13, 36, 49, 51
68012435	LOCATOR R-Tx® High Retention Insert Clear 4 pcs ..... 9, 11, 13, 36, 49, 51
68012438	LOCATOR R-Tx® High Retention Limited Range Insert Gold 4 pcs..... 9, 11, 13, 36, 49, 51
68012444	LOCATOR R-Tx® Impression Coping 4 pcs... 8, 10, 12, 38, 48, 50
68012446	LOCATOR R-Tx® Retention Insert Tool .....38
68012433	LOCATOR R-Tx® Low Retention Insert Blue 4 pcs ..... 9, 11, 13, 36, 49, 51
68012436	LOCATOR R-Tx® Low Retention Limited Range Insert Aqua 4 pcs..... 9, 11, 13, 36, 49, 51
68012434	LOCATOR R-Tx® Medium Retention Insert Pink 4 pcs ..... 9, 11, 13, 36, 49, 51
68012437	LOCATOR R-Tx® Medium Retention Limited Range Insert Magenta 4 pcs..... 9, 11, 13, 36, 49, 51
68012439	LOCATOR R-Tx® Mixed Retention Limited Range Processing Pack 2 pcs..... 9, 11, 13, 36, 49, 51
68012440	LOCATOR R-Tx® Processing Insert 4 pcs..... 9, 11, 13, 37, 49, 51
68012445	LOCATOR R-Tx® Processing Spacer 4 pcs... 9, 11, 13, 37, 49, 51
68012432	LOCATOR R-Tx® Zero Retention Insert Grey 4 pcs ..... 9, 11, 13, 36, 49, 51
68012214	MultiBase Abutment EV (L) 1.5mm 17° .....12, 31
68012218	MultiBase Abutment EV (L) 1.5mm 17° NI .....12, 31, 50
68012221	MultiBase Abutment EV (L) 1.5mm 30° .....12, 31
68012223	MultiBase Abutment EV (L) 1.5mm 30° NI .....12, 31, 50
68012210	MultiBase Abutment EV (L) 1.5mm NI .....12, 31, 50
68012215	MultiBase Abutment EV (L) 2.5mm 17° .....12, 31
68012219	MultiBase Abutment EV (L) 2.5mm 17° NI .....12, 31, 50
68012222	MultiBase Abutment EV (L) 2.5mm 30° .....12, 31
68012224	MultiBase Abutment EV (L) 2.5mm 30° NI .....12, 31, 50
68012211	MultiBase Abutment EV (L) 2.5mm NI .....12, 31, 50
68012216	MultiBase Abutment EV (L) 3.5mm 17° .....12, 31
68012220	MultiBase Abutment EV (L) 3.5mm 17° NI .....12, 31, 50
68012212	MultiBase Abutment EV (L) 3.5mm NI .....12, 31, 50
68012217	MultiBase Abutment EV (L) 4.5mm 17° .....12, 31
68012352	MultiBase Abutment EV (L) 4.5mm 17° NI .....12, 31, 50
68012213	MultiBase Abutment EV (L) 4.5mm NI .....12, 31, 50
68012198	MultiBase Abutment EV (M) 1.5mm 17° .....10, 30
68012202	MultiBase Abutment EV (M) 1.5mm 17° NI .....10, 30, 48
68012206	MultiBase Abutment EV (M) 1.5mm 30° .....10, 30
68012208	MultiBase Abutment EV (M) 1.5mm 30° NI .....10, 30, 48
68012194	MultiBase Abutment EV (M) 1.5mm NI .....10, 30, 48
68012199	MultiBase Abutment EV (M) 2.5mm 17° .....10, 30
68012203	MultiBase Abutment EV (M) 2.5mm 17° NI .....10, 30, 48
68012207	MultiBase Abutment EV (M) 2.5mm 30° .....10, 30
68012209	MultiBase Abutment EV (M) 2.5mm 30° NI .....10, 30, 48
68012195	MultiBase Abutment EV (M) 2.5mm NI .....10, 30, 48
68012200	MultiBase Abutment EV (M) 3.5mm 17° .....10, 30
68012204	MultiBase Abutment EV (M) 3.5mm 17° NI .....10, 30, 48
68012196	MultiBase Abutment EV (M) 3.5mm NI .....10, 30, 48
68012201	MultiBase Abutment EV (M) 4.5mm 17° .....10, 30
68012205	MultiBase Abutment EV (M) 4.5mm 17° NI .....10, 30, 48
68012197	MultiBase Abutment EV (M) 4.5mm NI .....10, 30, 48
68012178	MultiBase Abutment EV (S) 1.5mm 17° .....8, 29
68012182	MultiBase Abutment EV (S) 1.5mm 17° NI .....8, 29
68012186	MultiBase Abutment EV (S) 1.5mm 30° .....8, 29



Order No.	page	Order No.	page		
68012190	MultiBase Abutment EV (S) 1.5mm 30° NI.....	8, 29	68012052	TiDesign EV (L) Ø7.0 1.5mm.....	12, 26
68012174	MultiBase Abutment EV (S) 1.5mm NI.....	8, 29	68012061	TiDesign EV (L) Ø7.0 1.5mm Tri.....	12, 26
68012179	MultiBase Abutment EV (S) 2.5mm 17°.....	8, 29	68012053	TiDesign EV (L) Ø7.0 2.5mm.....	12, 26
68012183	MultiBase Abutment EV (S) 2.5mm 17° NI.....	8, 29	68012054	TiDesign EV (L) Ø7.0 3.5mm Tri.....	12, 26
68012187	MultiBase Abutment EV (S) 2.5mm 30°.....	8, 29	68012055	TiDesign EV (L) Ø7.0 4.5mm.....	12, 26
68012191	MultiBase Abutment EV (S) 2.5mm 30° NI.....	8, 29	68012042	TiDesign EV (M) Ø5.5 1.5mm.....	10, 26
68012175	MultiBase Abutment EV (S) 2.5mm NI.....	8, 29	68012046	TiDesign EV (M) Ø5.5 1.5mm 15°.....	10, 26
68012180	MultiBase Abutment EV (S) 3.5mm 17°.....	8, 29	68012050	TiDesign EV (M) Ø5.5 1.5mm Tri.....	10, 26
68012184	MultiBase Abutment EV (S) 3.5mm 17° NI.....	8, 29	68012043	TiDesign EV (M) Ø5.5 2.5mm.....	10, 26
68012176	MultiBase Abutment EV (S) 3.5mm NI.....	8, 29	68012047	TiDesign EV (M) Ø5.5 2.5mm 15°.....	10, 26
68012181	MultiBase Abutment EV (S) 4.5mm 17°.....	8, 29	68012044	TiDesign EV (M) Ø5.5 3.5mm.....	10, 26
68012185	MultiBase Abutment EV (S) 4.5mm 17° NI.....	8, 29	68012048	TiDesign EV (M) Ø5.5 3.5mm 15°.....	10, 26
68012177	MultiBase Abutment EV (S) 4.5mm NI.....	8, 29	68012045	TiDesign EV (M) Ø5.5 4.5mm.....	10, 26
68012225	MultiBase Abutment EV (XL) 1.5mm NI.....	14, 31	68012049	TiDesign EV (M) Ø5.5 4.5mm 15°.....	10, 26
68012226	MultiBase Abutment EV (XL) 2.5mm NI.....	14, 31	68012051	TiDesign EV (M) Ø7.0 1.5mm Tri.....	10, 26
68012227	MultiBase Abutment EV (XL) 3.5mm NI.....	14, 31	68012009	TiDesign EV (S) Ø4.5 1.5mm.....	8, 25
68012228	MultiBase Abutment EV (XL) 4.5mm NI.....	14, 31	68012017	TiDesign EV (S) Ø4.5 1.5mm 15°.....	8, 25
68012171	MultiBase Abutment EV (XS) 1.5mm NI.....	6, 29	68012025	TiDesign EV (S) Ø5.5 1.5mm Tri.....	8, 25
68012172	MultiBase Abutment EV (XS) 2.5mm NI.....	6, 29	68012010	TiDesign EV (S) Ø4.5 2.5mm.....	8, 25
68012173	MultiBase Abutment EV (XS) 3.5mm NI.....	6, 29	68012018	TiDesign EV (S) Ø4.5 2.5mm 15°.....	8, 25
68012229	MultiBase Abutment Head with holder.....	32	68012011	TiDesign EV (S) Ø4.5 3.5mm.....	8, 25
68012238	MultiBase Analog.....	6, 8, 10, 12, 14, 34, 48, 50	68012019	TiDesign EV (S) Ø4.5 3.5mm 15°.....	8, 25
68012233	MultiBase Bridge Screw.....	6, 8, 10, 12, 14, 34, 48, 50	68012012	TiDesign EV (S) Ø4.5 4.5mm.....	8, 25
68012240	MultiBase Burnout Cylinder.....	6, 8, 10, 12, 14, 33, 48, 50	68012020	TiDesign EV (S) Ø4.5 4.5mm 15°.....	8, 25
68012244	MultiBase Driver.....	42	68012062	TiDesign EV (XL) Ø7.0 1.5mm.....	14, 27
68012230	MultiBase Heal Cap Ø5.4 4mm.....	6, 8, 10, 12, 14, 32, 48, 50	68012064	TiDesign EV (XL) Ø7.0 1.5mm 15°.....	14, 27
68012234	MultiBase Lab Abutment Pin 14mm.....	6, 8, 10, 12, 14, 34, 48, 50	68012063	TiDesign EV (XL) Ø7.0 2.5mm.....	14, 27
68012235	MultiBase Lab Abutment Pin 18mm.....	6, 8, 10, 12, 14, 34, 48, 50	68012065	TiDesign EV (XL) Ø7.0 2.5mm 15°.....	14, 27
68012236	MultiBase Lab Abutment Pin 22mm.....	6, 8, 10, 12, 14, 34, 48, 50	68012001	TiDesign EV (XS) Ø4.0 1.5mm.....	6, 25
68012237	MultiBase Lab Bridge Screw 4 pcs.....	6, 8, 10, 12, 14, 34, 48, 50	68012005	TiDesign EV (XS) Ø4.0 1.5mm 15°.....	6, 25
68012232	MultiBase Pick-Up.....	6, 8, 10, 12, 14, 32, 48, 50	68012002	TiDesign EV (XS) Ø4.0 2.5mm.....	6, 26
68012243	MultiBase Semi-Burnout Cylinder.....	6, 8, 10, 12, 14, 33, 48, 50	68012006	TiDesign EV (XS) Ø4.0 2.5mm 15°.....	6, 25
68012239	MultiBase Temporary Cylinder.....	6, 8, 10, 12, 14, 33, 48, 50	68012003	TiDesign EV (XS) Ø4.0 3.5mm.....	6, 25
68012231	MultiBase Transfer.....	6, 8, 10, 12, 14, 32, 48, 50	68012007	TiDesign EV (XS) Ø4.0 3.5mm 15°.....	6, 25
68015288	Prosthetic Tray.....	45	68012004	TiDesign EV (XS) Ø4.0 4.5mm.....	6, 25
68012241	Protection sleeve.....	33	68012008	TiDesign EV (XS) Ø4.0 4.5mm 15°.....	6, 26
68013072	TempAbutment EV (L).....	19	25595	TiDesign Profile EV 4.2 Ø5.5 15° 2mm.....	48, 56
68013070	TempAbutment EV (M).....	19	25592	TiDesign Profile EV 4.2 Ø5.5 2mm.....	48, 56
68013066	TempAbutment EV (S).....	19	25594	TiDesign Profile EV 4.2 Ø5.5 3mm.....	48, 56
68013074	TempAbutment EV (XL).....	19	25593	TiDesign Profile EV 4.2 Ø7.0 2mm.....	48, 56
68013064	TempAbutment EV (XS).....	19	25599	TiDesign Profile EV 4.8 Ø5.5 15° 2mm.....	50, 56
68010014	TempBase Cap (L).....	12, 20	25596	TiDesign Profile EV 4.8 Ø5.5 2mm.....	50, 56
68010015	TempBase Cap (XL).....	14, 20	25597	TiDesign Profile EV 4.8 Ø7.0 2mm.....	50, 56
68010013	TempBase Cap (XS) (S) (M).....	6, 8, 10, 20	25598	TiDesign Profile EV 4.8 Ø7.0.5 3mm.....	50, 56
26256	Temp Abutment Profile EV 4.2 Ø4.5.....	48, 53	68012090	TitaniumBase EV (L) 1mm.....	13, 28
26257	Temp Abutment Profile EV 4.8 Ø5.0.....	50, 53	68012091	TitaniumBase EV (L) 2mm.....	13, 28
25503	TempDesign EV 3.0 Ø6 5mm.....	19	68012088	TitaniumBase EV (M) 1mm.....	11, 28
25504	TempDesign EV 3.6 Ø7 5mm.....	19	68012089	TitaniumBase EV (M) 2mm.....	11, 28
25505	TempDesign EV 4.2 Ø9 5mm.....	19	68012083	TitaniumBase EV (S) 1mm.....	9, 28
25506	TempDesign EV 4.8 Ø10 5mm.....	19	68012084	TitaniumBase EV (S) 2mm.....	9, 28
25507	TempDesign EV 5.4 Ø10 5mm.....	19	68012092	TitaniumBase EV (XL) 1mm.....	15, 28
25556	TempDesign Profile EV 4.2 Ø7.....	48, 53	68012093	TitaniumBase EV (XL) 2mm.....	15, 28
25557	TempDesign Profile EV 4.8 Ø8.....	50, 53	68012081	TitaniumBase EV (XS) 1mm.....	7, 28
68012056	TiDesign EV (L) Ø5.5 1.5mm 15°.....	12, 26	68012082	TitaniumBase EV (XS) 2mm.....	7, 28
68012060	TiDesign EV (L) Ø5.5 1.5mm Tri.....	12, 26	25774	Torque Wrench EV.....	43
68012057	TiDesign EV (L) Ø5.5 2.5mm 15°.....	12, 26	25776	Torque Wrench EV Restorative Driver Handle.....	43
68012058	TiDesign EV (L) Ø5.5 3.5mm 15°.....	12, 26	25777	Torque Wrench EV Restorative Driver Handle Low.....	43
68012059	TiDesign EV (L) Ø5.5 4.5mm 15°.....	12, 26	25775	Torque Wrench EV Surgical Driver Handle.....	43





---

THE DENTAL  
SOLUTIONS  
COMPANY™

