

DS Implants™

DS PrimeTaper™  
Surgical manual





This manual is designed for use by clinicians who have undergone at least basic prosthetic and in-clinic implant training. Staying current on the latest trends and treatment techniques in implant dentistry through continued education is the responsibility of the clinician.

All products may not be regulatory cleared/released/licensed in all markets. Please contact the local Dentsply Sirona sales office for current product assortment and availability.

To improve readability for our customers, Dentsply Sirona does not use ® or ™ in body copy. However, Dentsply Sirona does not waive any right to the trademark and nothing herein shall be interpreted to the contrary.

Product illustrations are not to scale.

# CONTENTS

<b>1. Introduction to DS PrimeTaper</b> .....	4	<b>7. Guided Surgery</b> .....	22
Implant design.....	4	Computer-guided 3D planning and implant installation.....	22
Color coding.....	5	<b>8. Guided Surgery Instruments</b> .....	23
Implant-abutment connection.....	5	Mucosal punch.....	23
Restorative solutions.....	5	Drills.....	23
<b>2. Treatment planning</b> .....	6	Implant driver.....	24
Conventional treatment planning.....	6	Stabilization abutment.....	24
Computer-guided treatment planning.....	6	Guide fixation.....	24
Clinical application.....	7	Surgical tray guided surgery.....	25
<b>3. Instruments</b> .....	8	<b>9. Implant SAFE Guide</b> .....	26
Drills.....	8	Types of support.....	26
Implant drivers.....	10	Tooth-supported procedure.....	27
Torque wrench.....	11	Bone-supported procedure.....	27
Hex drivers.....	11	Mucosa-supported procedure.....	28
Surgical tray.....	12	<b>10. Implant site preparation - Guided Surgery</b> .....	29
<b>4. Implant site preparation</b> .....	14	<b>11. Implant installation - Guided Surgery</b> .....	32
Drilling protocol.....	14		
Implant site preparation procedure.....	16		
<b>5. Implant packaging</b> .....	18		
<b>6. Implant installation</b> .....	19		
One-stage surgical protocol.....	20		
Two-stage surgical protocol.....	21		
Torque guide.....	21		



# 1. Introduction to DS PrimeTaper

## Implant design

The DS PrimeTaper implant is designed with a progressive taper and thread, together with the clinically proven OsseoSpeed surface and MicroThread from the Astra Tech Implant System.



MicroThread

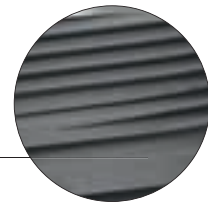

OsseoSpeed surface

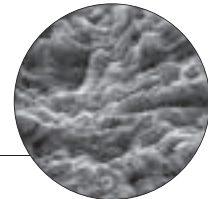





Progressive taper and thread design



## Color coding

The DS PrimeTaper Implant line is available in different diameters and lengths. The color coding makes it easy to identify the correct connection and to select the right prosthetic components.

Implant Ø mm	3.0	3.6	4.2	4.8	5.4
Connections					
Lengths mm	-	-	6.5	6.5	6.5
	8	8	8	8	8
	9	9	9	9	9
	11	11	11	11	11
	13	13	13	13	13
	15	15	15	15	15
	-	17	17	17	-

## Implant-abutment connection

The implants have a unique interface providing three different options for abutment placement/indexing.

- One-position-only**

Atlantis patient-specific abutments will seat in one position only.



- Six positions**

Indexed abutments will seat in six available positions. Including pre-surgically manufactured Atlantis abutments.



- Non-indexed**

Non-indexed abutments will be seated in any rotational position.



## Restorative solutions

The implants portfolio offers prefabricated and patient-specific abutments. Restorations include prosthetic options on implant and abutment levels, with various types of fixation possibilities e.g. screw-, cement-, friction- and attachment-retained restorations.

## 2. Treatment planning

Pre-operative planning should be based on the expected restorative treatment outcome. Therefore treatment planning should include all stages of the procedure, from healing time and components to temporary and final restorations.

The treatment planning is based on a comprehensive consultation with the patient to determine exactly what the patient wants and expects from the treatment, but also to discover any possible contraindications and to explain the treatment in detail to the patient.

It is followed by a complete general and specific medical history and intraoral examination with analysis of the initial anatomical situation.

The following points must be considered:

- Medical and dental history
- General diagnoses – exclusion of contraindications
- Specialist consultation for risk factors
- Detailed intraoral examination including general radiographic examination

After examination and evaluation of the diagnostic documentation, the treatment plan should be prepared.

Even though the final treatment approach may be determined at the time of surgery, consider the following based on the quality of supporting bone and expected initial stability of the implant(s):

- One- or two-stage surgical procedure
- Immediate or early loading protocol
- Expected healing time before loading

When determining time to loading of implants for each individual case, the following should be carefully examined and assessed:

- Bone quality and quantity
- Primary stability
- Design of restoration
- Loading conditions

Before treatment begins, the patient should be informed about the results of the pre-operative examination and given a clear explanation of what the planned treatment entails, including the expected outcome, maintenance requirements and risks involved.

Accurate planning of every implant procedure is essential for the long-term success of the treatment. The planning process defines all actions and lists alternatives that can meet the patient's expectations of the function and esthetics of the implant-prosthetic rehabilitation.

---

### Conventional treatment planning

A diagnostic wax-up with the missing teeth replaced provides important information in the planning phase.

Based on analysis and evaluation of the occlusal table, force distribution and preferred sites for the implants, an optimal plan can be achieved.

The diagnostic wax-up and radiographs make it possible to plan implant position, angulation and size in order to support the planned prosthetic construction in an optimal way.

A surgical guide can be manufactured and used during surgery to aid the implant installation.

### Computer-guided treatment planning

Digital treatment planning based on three-dimensional imaging procedures enables the therapy to be planned with accuracy and makes the implant installation procedure predictable and precise.

Guided Surgery from DS Implants offers a complete solution for digital treatment planning with Simplant software and guided implant installation with the Simplant SAFE Guide.



## Clinical application

The implants are used for both one- and two-stage surgical procedures in the following situations and with the following clinical protocols:

- Replacing missing teeth in single or multiple unit applications in the mandible or maxilla.
- Immediate placement in extraction sites and in situations with a partially or completely healed alveolar ridge.
- Especially indicated for use in soft bone applications where implants with other implant surface treatments may be less effective.
- Immediate and early loading for all indications, except in single tooth situations on implant shorter than 8mm or in soft bone (type IV) where implant stability may be difficult to obtain and immediate loading may not be appropriate.
- The intended use for PrimeTaper EV implant Ø3.0 is limited to replacement of maxillary lateral incisors and mandibular incisors.

Based on mechanical strength considerations it is recommended to always place the widest implant possible for the edentulous space. This is particularly important in the posterior regions of the jaws where loading forces are high and considerable bending moments could be generated.

In all cases it is important to consider loading conditions when determining the number and spacing of implants.

# 3. Instruments

## Drills

The implant site is prepared in accordance with the drilling protocol to ensure simple and safe implant placement in all bone qualities.

### Guide Drill

- Used to mark a starting point



### Precision Drill

- Used to mark a starting point

The Precision Drill is an extremely sharp drill and should be handled with caution to avoid injury.



### PrimeTaper Drills

- For implant site preparation up to the planned implant diameter
- Depth marked
- Multiple use with option for single use
- Marked with the respective diameters and numbers (1-7)
- Available in two lengths:

Drill short 6.5-13mm  
 Drill long 6.5-17mm

Ø mm	1.9	2.35	2.95	3.55	4.15	4.75	5.35
Drill number	1	2	3	4	5	6	7



The effective drilling depth is maximum 1mm more than the implant length, indicated by the depth marking.



### PrimeTaper Taps

- For very dense bone preparation
- Depth marked 6.5mm
- Multiple use with option for single use



Ø mm	3.0	3.6	4.2	4.8	5.4

### Intermediate drills

- Intermediate drills for fine-tuning the diameter of the osteotomy
- Depth marked
- Multiple use with option for single use
- Marked with the respective diameters
- Available in two lengths

Ø mm	2.65	3.25	3.85	4.45	5.05
Drill number	②½	③½	④½	⑤½	⑥½

All drills except the Precision Drill can be used for maximum ten cases. They should be carefully cleaned and sterilized after each surgery and replaced as soon as a decrease in cutting efficiency is observed.

### PrimeTaper Direction indicator

- Used after drill ① and drill ③
- Used for visualizing the position and direction of the prepared osteotomy and for measuring the space between osteotomies.

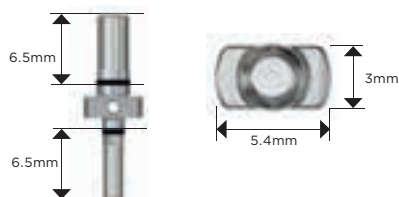

### Implant Depth Gauge

- Used for measuring the depth of the implant site
- Markings correspond to the implant lengths
- The other end of the gauge can be used as a measuring probe.



### Instrument Extender

- Used for extending the length of a drill or implant driver
- Ensure sufficient irrigation when using the extender













## Implant drivers

The implant drivers can be used with a contra angle or with a surgical driver handle and a torque wrench.

### Implant Driver EV

- For implant installation
- Color-coded and depth marked
- Available in short and long

Ø mm	3.0	3.6	4.2	4.8	5.4
Color coding					
					

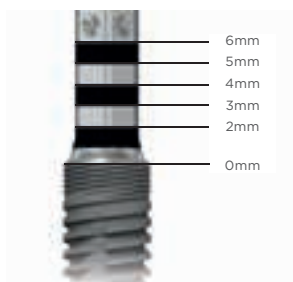

6mm  
5mm  
4mm  
3mm  
2mm  
0mm

The reference point ("0") of the depth markings is the intended bone level, i.e., the lowest point of the bone level.

To facilitate optimal placement of pre-designed abutments, align one of the dots buccally.

Carefully clean and sterilize the driver after each surgery and replace it as soon as any decrease in functionality is observed. The Implant Driver EV can be used for approximately 100 implant installations.



## Torque wrench

### Torque Wrench EV

- For implant installation and adjustment of the implant position
- Used together with the surgical driver handle



### Torque Wrench EV Surgical Driver Handle

- Used together with the torque wrench



## Hex drivers

- Used for tightening screws, surgical and restorative components

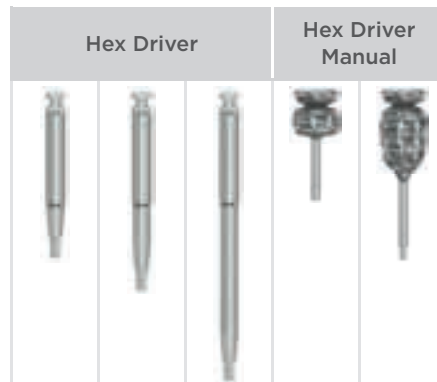



## Surgical tray

All instruments for surgical use are stored in the PrimeTaper Surgical Tray, which is designed to make all instruments easily accessible, easy to clean and sterilize. The instruments are arranged in order of usage. For preparation with guided surgery a separate surgical tray is available.

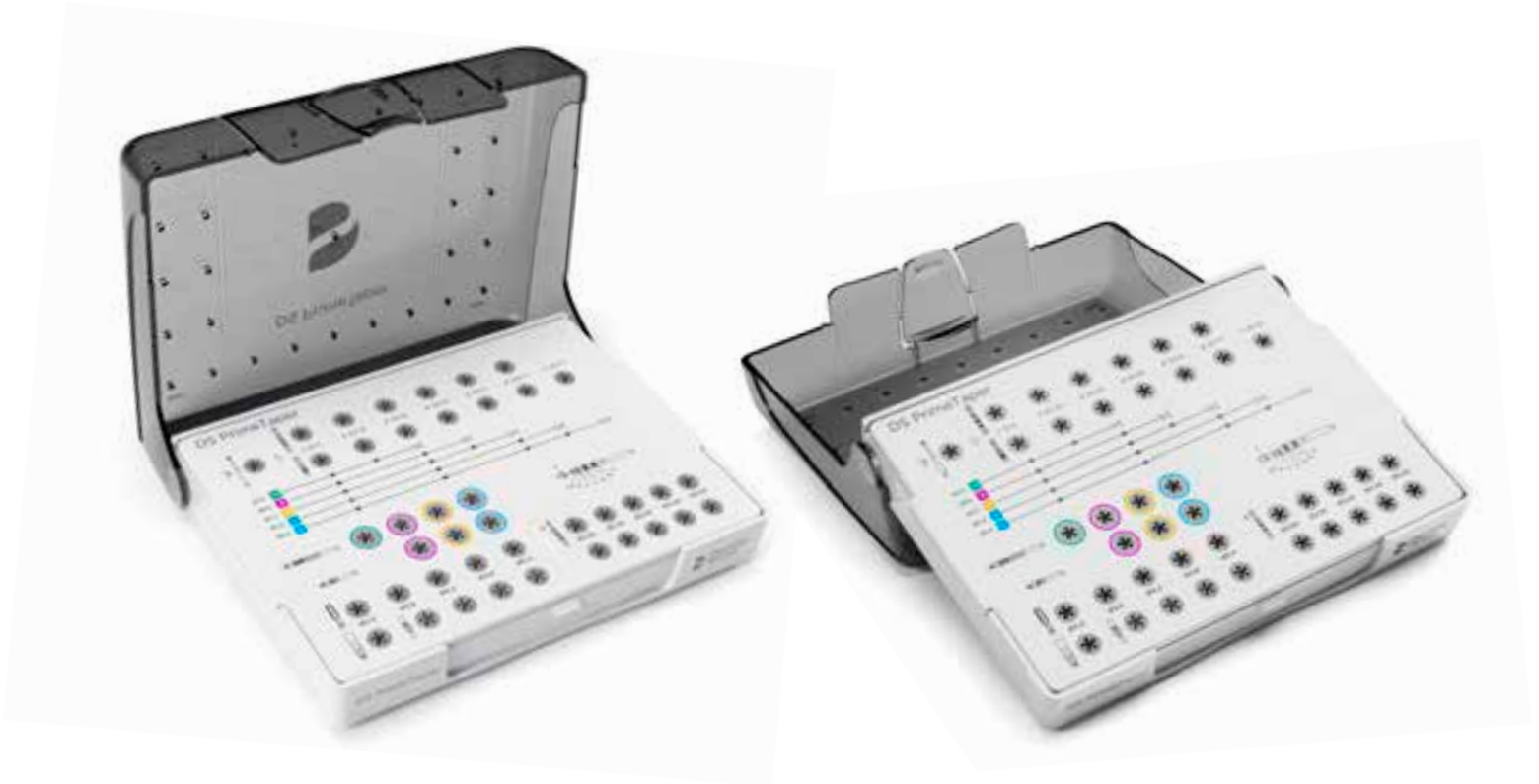

QR code for additional information about the surgical tray.



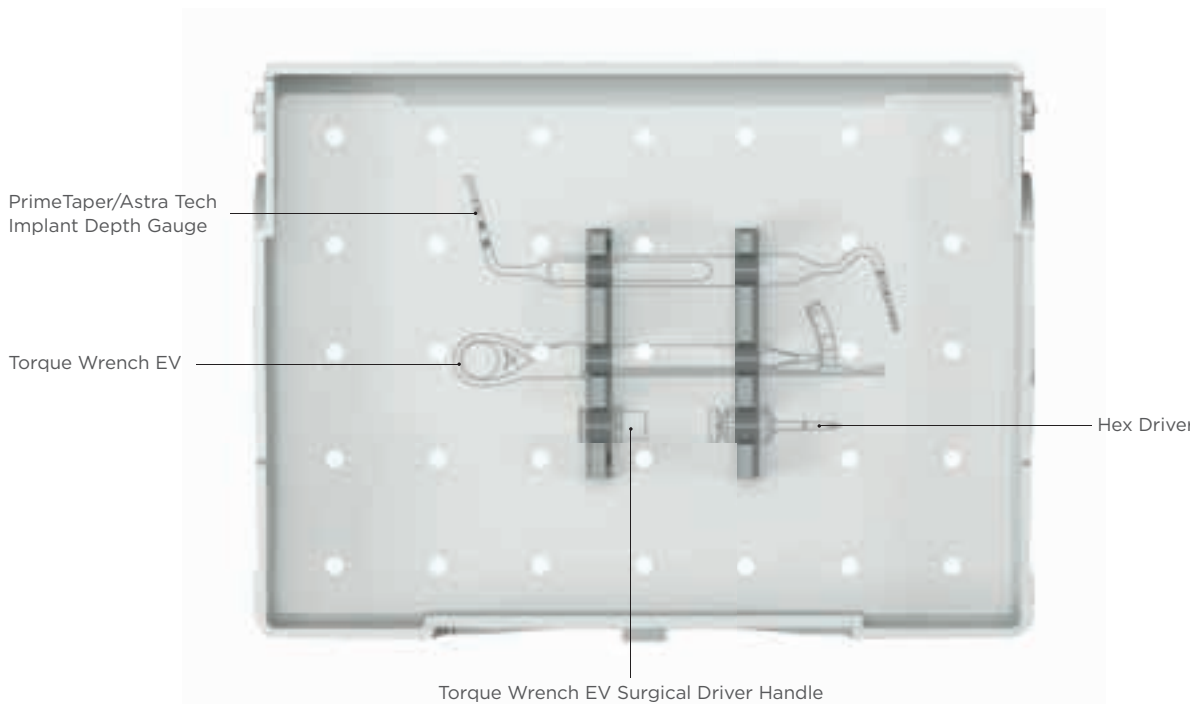
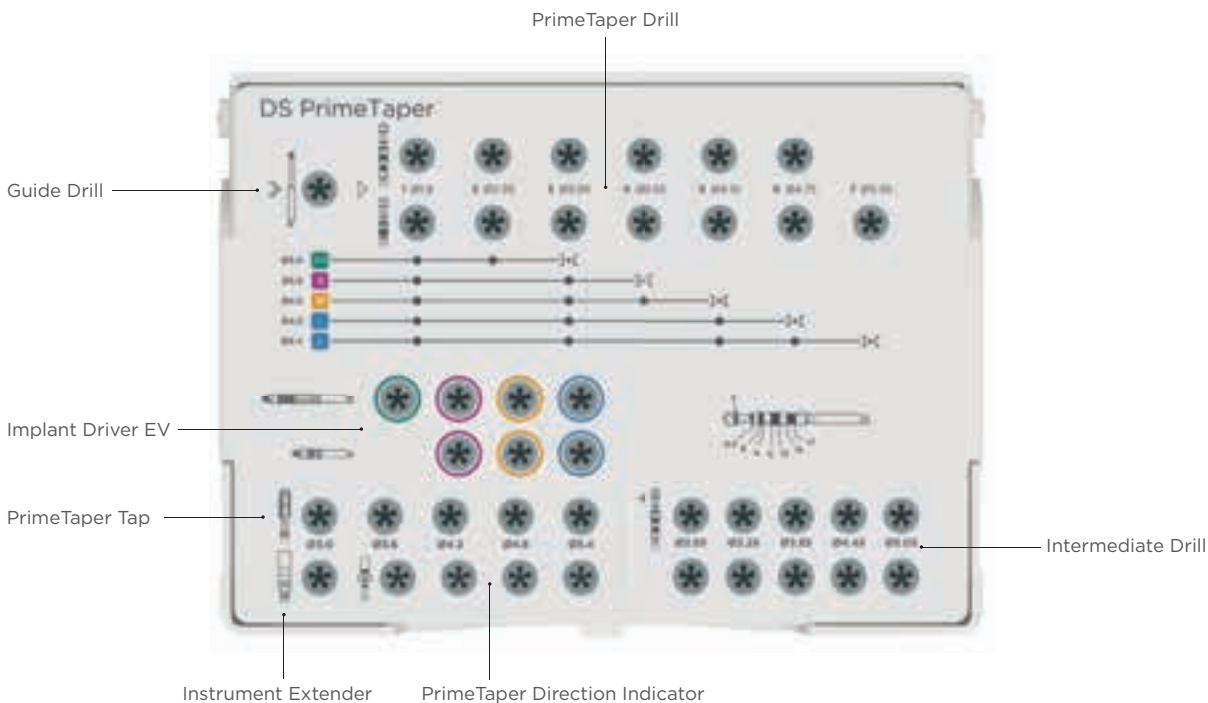

**Cleaning and sterilization instructions**

Products within DS Implants are designed to be cleaned and sterilized before clinical use with the exception of sterile packed products. The cleaning and sterilization instructions have been developed and validated by Dentsply Sirona in accordance with the applicable standards. For further information and step-by-step procedures, refer to the Cleaning and sterilization instruction manual. For products with other legal manufacturer, see respective product's IFU.

## 4. Implant site preparation

It is important to obtain knowledge about the bone quality available at the implant site, as it may vary in the maxilla and the mandible. During the planning phase it is also crucial to check that the horizontal and vertical bone volume is sufficient for placement of an implant.

According to Misch<sup>1</sup>, Lekholm and Zarb<sup>2</sup>, bone of various qualities can be classified into four classes D I - D IV.

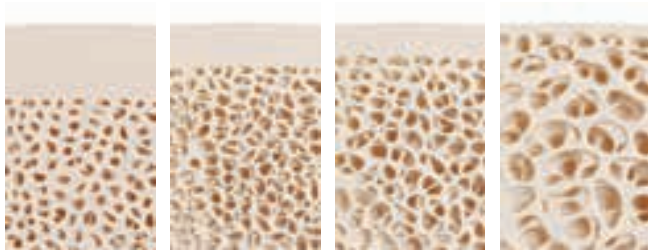

Bone class	Bone class	Bone class	Bone class
D I	D II	D III	D IV
Dense cortical bone, almost no spongy bone.	Dense cortical bone, large-grain spongy bone.	Thin cortical bone, fine-meshed spongy bone.	No cortical bone, fine spongy bone.

### Drilling protocol

Recommended drilling protocol for soft, medium and dense bone qualities

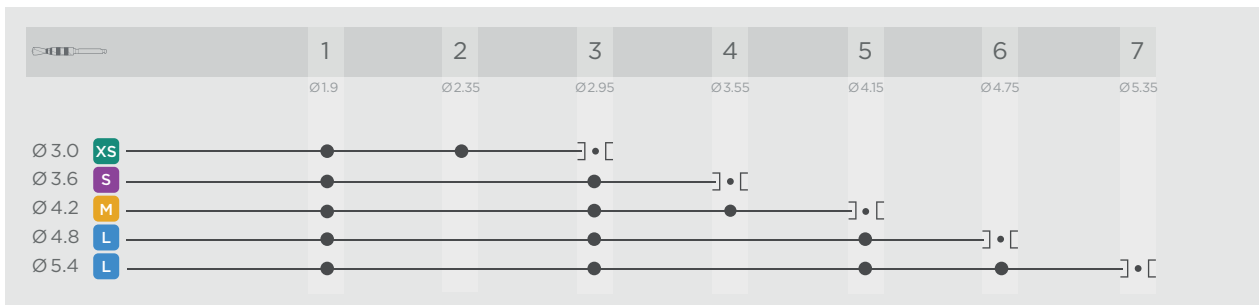

- Figures refer to drill numbers 1-7
- [ refers to cortical preparation only (mandatory)
- Adapt the cortical preparation to the individual thickness of the cortex
- Drilling to the 2mm marking, using the drill for cortical preparation "• [", will ensure sufficient space for the MicroThread portion of the implant

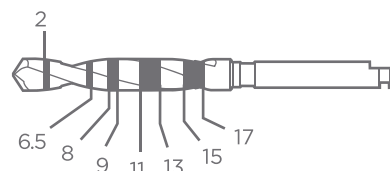

#### References:

- Misch CE: Density of bone: Effect on treatment plans, surgical approach, healing, and progressive bone loading. *Int J Oral Implantol* 1990;6(2):23-31.
- Lekholm U, Zarb GA: Patient selection and preparation. In: Branemark PI, Zarb GA, Albrektsson T (eds): *Tissue-integrated prostheses. Osseointegration in clinical dentistry*. Quintessence, Chicago 1985:199-209.

### Drilling protocol for very soft bone

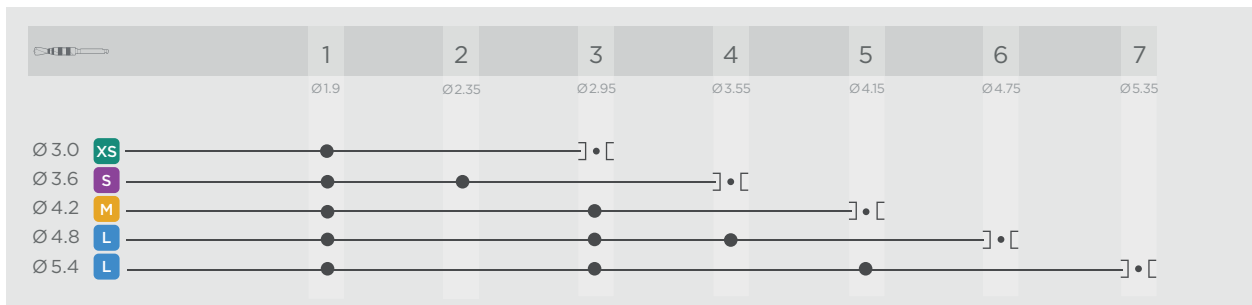

- May be applicable in extraction sockets

### Drilling protocol for very dense bone

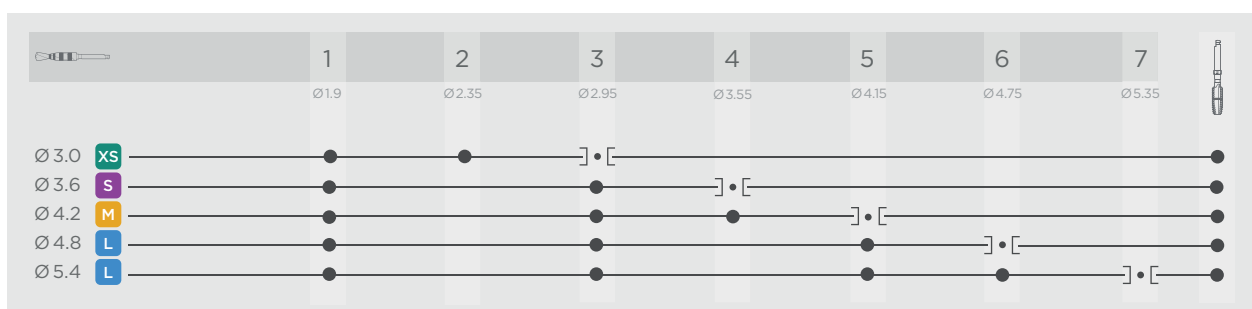

- PrimeTaper Tap is available, used after cortical preparation ] [

### Osteotomy fine-tuning

Five additional intermediate drills, 2 ½ - 6 ½, are available for fine-tuning the diameter of the osteotomy.

This is useful if you desire a slight widening of the osteotomy or a slight under-preparation, compared to the recommended protocol.

Finalize the osteotomy with cortical preparation ] [.

## Implant site preparation procedure

The following images show the implant site preparation for PrimeTaper EV Ø4.2 x 11mm, using the recommended protocol.



### Incision

- Make an incision.
- Mobilize and fold back the mucoperiosteal flap.



### Marking

- Mark the cortical bone with the Guide Drill or the Precision Drill, to give the next drill a secure starting point.

The Precision Drill is an extremely sharp drill and should be handled with caution to avoid injury.



### Blister

- Open the package and place the blister onto a sterile area.
- Secure the drill by squeezing the blister.

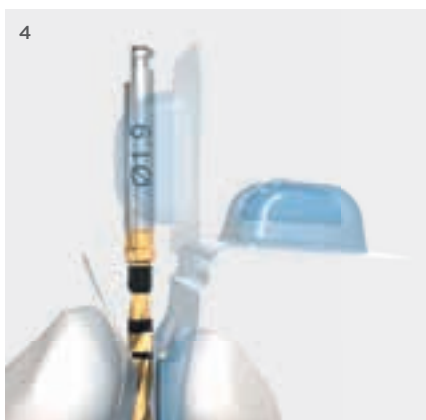

### Blister

- Expose the drill shaft by bending back the top of the blister.

Cutting instruments should generally be replaced after ten cycles of use. Blunt or damaged instruments must be replaced immediately. Gentle, thorough disinfection and cleaning, will ensure an optimal operation of the drills.



### Pick-up

- Engage the drill with the contra angle.



### Drill 1 Ø1.9

- Drill in the planned direction to the appropriate depth.
- The drilling will provide valuable information about the cortical and spongy bone.
- Insert the smaller end of the PrimeTaper Direction Indicator into the site to visualize/verify the direction.

Maximum drilling speed is 1500 rpm, with profuse irrigation.



## Implant site preparation procedure

**PrimeTaper Drill 3 Ø2.95**

- Drill in the planned direction to the appropriate depth.
- Insert the larger end of the direction indicator into the site to visualize/verify the direction.

**PrimeTaper Drill 4 Ø3.55**

- Drill in the planned direction to the appropriate depth.
- Check the osteotomy depth by using the Implant Depth Gauge.

**Measuring the osteotomy**

- After drilling, carefully measure the depth of the implant site by using the depth gauge.
- Use the same clinical reference point for the depth as for the planned implant position.

The depth should allow the implant to be level with or slightly submerged in relation to adjacent marginal bone.

**Cortical preparation of the bone - PrimeTaper Drill 5 Ø4.15****1mm thick cortex**

- Cortical preparation is marked with this symbol ] [ in the drilling protocol.
- Drill through the entire thickness of the cortical bone, in this case 1mm.

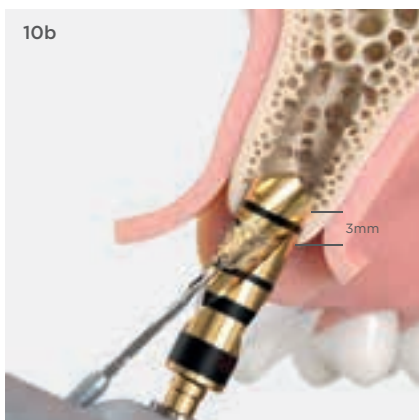
**3mm thick cortex**

- Drill through the entire thickness of the cortical bone, in this case 3mm.

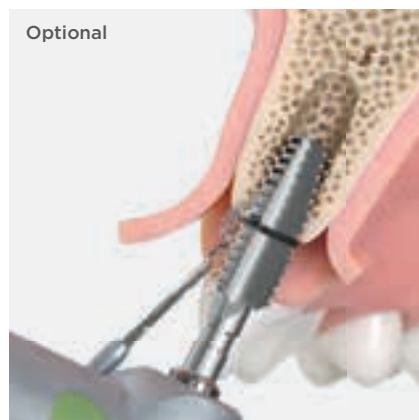
**Optional tapping in very dense bone**

- Prepare the site with the PrimeTaper Tap Ø4.2 at maximum 25 rpm through the cortical bone. The depth marking indicates 6.5mm.
- Turn the tap counter-clockwise to remove it from the osteotomy.

Drilling to the 2mm marking, using the drill for cortical preparation " ] [ ", will ensure sufficient space for the MicroThread portion of the implant.

## 5. Implant packaging

PrimeTaper EV implants are supplied in a blister container with an outer box.



### Outer box package

- Implant diameter, specific color coding according to EV connection and implant length information on side labels.
- QR codes accessible on two sides.
- Stackable, all important product information remains visible.
- Instructions For Use (IFU) available electronically (eIFU): [ifu.dentsplysirona.com](http://ifu.dentsplysirona.com)



### Blister

- Inner sterile package
- Contains implant container
- Peel-off label with batch code supporting a convenient documentation of the treatment.

## 6. Implant installation



### Implant container

- Open the blister package.
- Pour the sterile inner container onto a sterile area.
- Remove the cap from the container, using a twisting motion to expose the top of the implant.

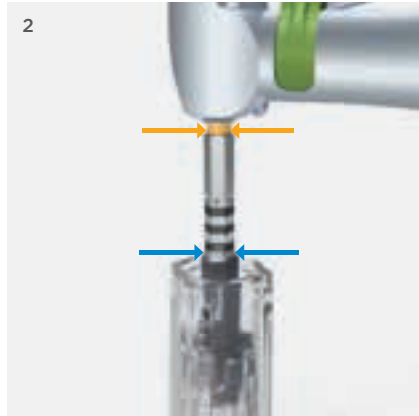

### Machine Implant pick-up

- Attach the appropriate Implant Driver EV to the contra angle, see yellow arrows.
- Carefully rotate the driver in the implant to align the indexing tabs.
- Make sure that the implant driver is fully seated into the implant, see blue arrows.

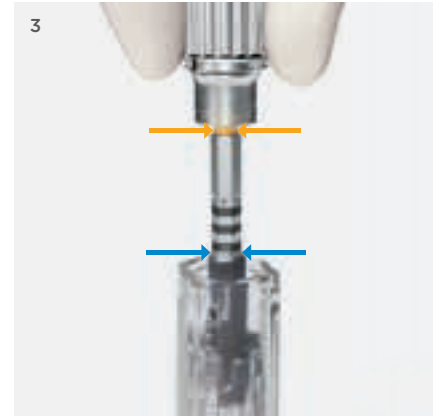

### Manual implant pick-up

- Attach the appropriate Implant Driver EV to the Surgical Driver Handle to pick up the implant.
- The driver is correctly seated when the color-coded marking is in contact with the handle, see yellow arrows.
- Carefully rotate the driver in the implant to align the indexing tabs.
- Make sure that the implant driver is fully seated into the implant, see blue arrows.



### Machine implant placement

- Install the implant with the contra angle at low speed (25 rpm) under profuse irrigation.
- Allow the implant to work its way into the osteotomy. Avoid applying unnecessary pressure. Do not exceed 45 Ncm when installing the implant. If not completely seated before reaching 45 Ncm, reverse/remove the implant and widen the osteotomy appropriately.



### Manual implant placement

- Install the implant with the implant driver and the surgical driver handle.



### Final positioning

- Attach the implant driver and the surgical driver handle into the torque wrench until there is an audible click.
- Position the implant at the marginal bone level or slightly below.
- Position one of the dots on the implant driver buccally to facilitate optimal placement of the pre-designed abutments.
- Release the implant driver by lifting it gently from the implant.

It is recommend to have a titanium forceps available in case the implant driver does not provide sufficient carrying function during the removal procedure.

## One-stage surgical protocol

If a one-stage procedure with transgingival healing is planned without preparation of an implant-supported temporary restoration, the implants can be covered with healing abutments. This is an option where an existing denture can be used as a temporary restoration. Healing abutments are also used for soft tissue sculpturing during the healing phase.



Round shapes are indicated for all positions in the mouth.



Triangular shapes for anterior implant sites to mimic the incisors and canines. The Triangular HealDesign EV is a two-piece abutment.

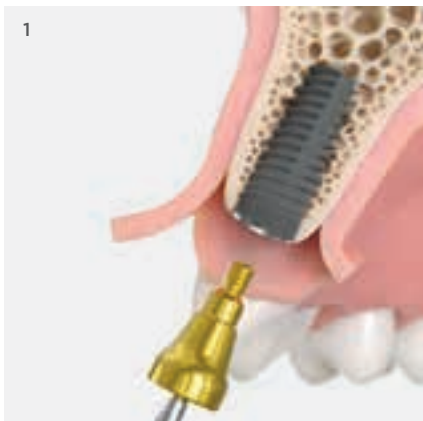

### Placing the healing abutment

- Place the HealDesign EV using the Hex Driver.
- Manually secure the healing abutment using light finger force (5-10 Ncm).



### Suturing

- Adapt and suture the soft tissue.

An existing temporary denture, such as a clasp denture or a bridge fixed to neighboring teeth, must be modified before delivery to ensure that there will be no pressure on the healing abutment.



## Two-stage surgical protocol

If a two-stage procedure is planned, the implant is sealed with a cover screw during the healing phase to prevent the entry of saliva and bacteria.



### Placement of the cover screw

- Insert the Cover Screw EV using the Hex Driver.
- Tighten with light finger force (5-10 Ncm).



### Suturing

- Replace and fix the tissue flaps with sutures.



### Exposure

- After the healing phase expose the implant for fabrication of the prosthetic restoration.
- Depending on the planned procedure, place a healing abutment or a temporary restoration.

## Torque guide

### Recommended installation and tightening torque

Type of product installation		Torque - Ncm
<ul style="list-style-type: none"> <li>■ Implant placement</li> </ul>		Maximum 45 Ncm
<ul style="list-style-type: none"> <li>■ Cover screws</li> <li>■ Healing components</li> </ul>		5 - 10 Ncm Manual/ light finger force

# 7. Guided Surgery

## Computer-guided 3D planning and implant installation

The implant installation procedure is planned in 3D with the Simplant software. It provides a complete image of the patient's anatomy for selection and placement of implants and abutments.

With the Simplant SAFE Guide (manufactured by Dentsply Sirona or 3D printed in the clinic using the Simplant Guide File) as well as with the CEREC Guide 3 (chairside manufacturing) you can work with fully guided procedure. This means that all surgical steps from soft-tissue punch to implant installation can be performed with the guide in place.

### Surgical simplicity

Using a Simplant Guide with DS PrimeTaper makes the procedure precise and safe.

- The "Sleeve-on-Drill" system simplifies handling and replaces the drill key which saves you an assisting hand.
- The guided surgery instrumentation is based on either absolute drill stops or depth markings.
- The optional lateral access of the Simplant SAFE Guide facilitates the handling even for cases with limited inter-occlusal space.
- When aligning the markings on the implant driver with the patient-specific marking on the Simplant Guide, it ensures that the implant is rotated as planned in the software.

### Color coding

The DS PrimeTaper implant line is available in different diameters and lengths. The color coding makes it easy to identify the correct connection and to select the right prosthetic components.

### DS PrimeTaper implants for use with Guided Surgery:

Implant Ø mm	3.6	4.2	4.8
Connections	<b>S</b>	<b>M</b>	<b>L</b>
Lengths mm	-	6.5	6.5
	8	8	8
	9	9	9
	11	11	11
	13	13	13
	15	15	15



## 8. Guided Surgery instruments

Specific instruments are available for guided surgery with PrimeTaper EV. They can only be used together with the Siplant SAFE Guide and CEREC Guide 3.

- All cutting instruments and drill sleeves are delivered sterile
- All instruments are multiple use, except punch and drill sleeve
- All drills are intended for use maximum 10 times or less if blunt
- Some products are also used for Astra Tech Implant EV. When references are made to 6mm depths or lengths, that corresponds to PrimeTaper Guided Surgery 6.5mm

### Mucosal punch

#### Punch EV-GS

Used to make a circular incision of the implant diameter in the mucosa up to the coronal bone level where the implant shoulder is to be positioned.

- Marking corresponds to the implant lengths
- Marked with diameter and for single use

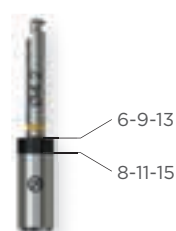

### Drills

#### Initial Drill EV-GS

Used to remove mucosa and to create a centering indentation in the bone for the following drills GS.

- Marking corresponds to the implant lengths
- Marked with diameter

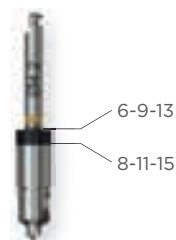

#### Sleeve-on-Drill system

Drills with a drill sleeve that can be attached to the instrument.

- When using the guide, a simple and precise guiding of the drill is guaranteed.
- The drill stop system ensures exact depth control.

#### PrimeTaper Drill GS

Used to prepare the implant site successively to the planned implant length and diameter. Used also for the cortical preparation with a drill sleeve attached. The 6.5-8mm lengths of Drill GS 4, 5 and 6 have appropriate depth markings from 1 to 4mm. The cortical drilling depth must be visually controlled not using the depth stop.

- Guided with the Sleeve-on-Drill system
- Marked with the respective diameter number (1-6), length.

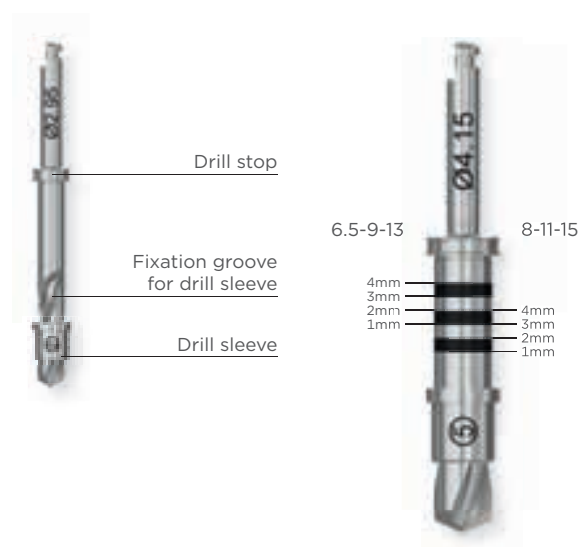

### PrimeTaper Drill GS (intermediate)

For fine-tuning the diameter of the osteotomy.

- Guided with the Sleeve-on-Drill system
- Marked with the respective diameter number (2½-5½) and length.

### PrimeTaper Tap GS

Used to tap a thread in very dense bone.

- Marked with diameter
- Markings correspond to preferred tapping depths for implant lengths 6.5-9-13mm and 8-11-15mm respectively

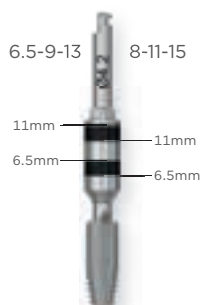

### PrimeTaper Drill Sleeve

For safe guidance of the drills in the surgical guide.

- Marked with the respective diameter and number
- Marked with ND (Narrow Diameter) when used with drills for implant Ø3.6mm and Ø4.2mm or WD (Wide Diameter) for implant Ø4.8mm



The drill sleeves are for single use only and must be removed from the drill immediately after use.

## Implant driver

### Implant Driver GS

Used to install the implant in the prepared implant site.

- It has 6 indexing tabs fitting the implant in any of the 6 internal positions
- 6 notches along the axis correspond to the 6 internal flat surfaces of the implant
- Two groves on the shaft indicate the corresponding installation depths 6.5-9-13mm and 8-11-15mm
- Color coded

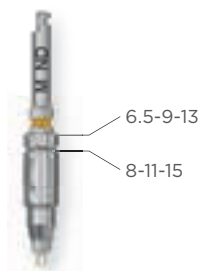

## Stabilization abutment

### EV-Stabilization Abutment

Used to prevent movement of the surgical guide during preparation of the implant site.

- Marked with diameter and implant length 6-9-13mm or 8-11-15mm
- Color coded



## Guide fixation

### Drill for Guide Fixation Screw

Used to prepare the bone for the fixation screw.



### Guide Fixation Screw

For precise implant placement by connecting mucosa-supported guides with the bone through the Guide Fixation Screw.





## Surgical tray guided surgery

All instruments for surgical use are stored in the PrimeTaper Surgical Tray GS, which is designed to make all instruments easily accessible, easy to clean and sterilize. The instruments are arranged in order of usage.

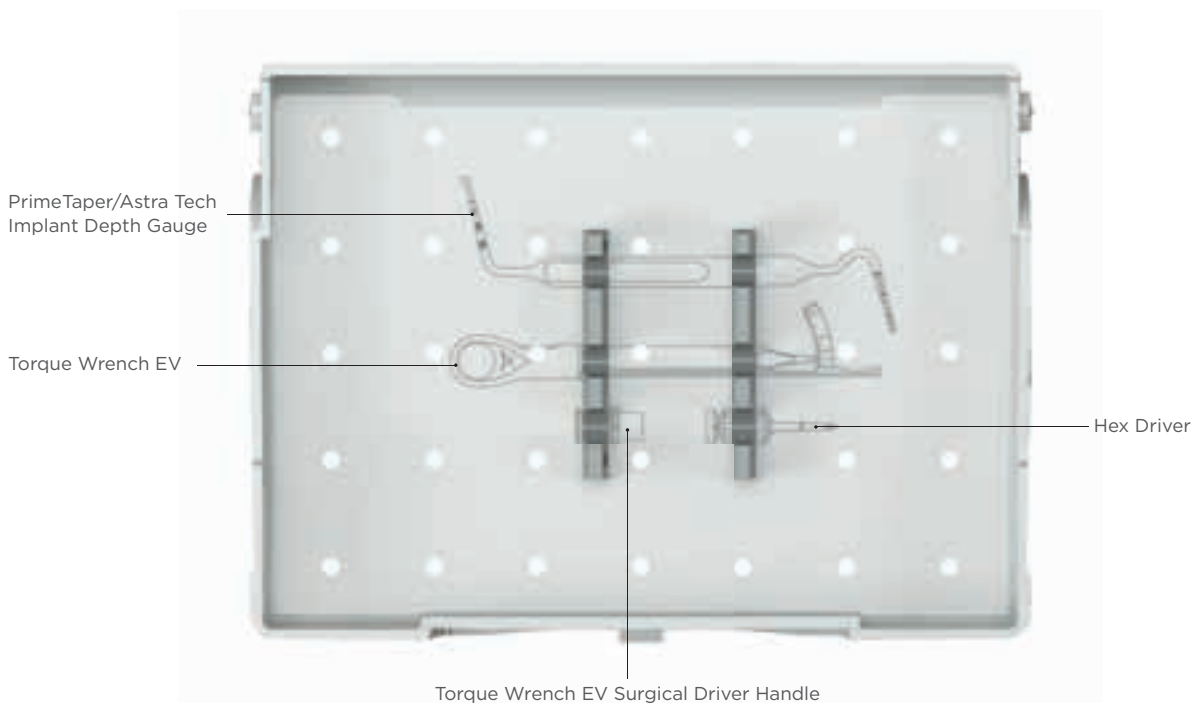
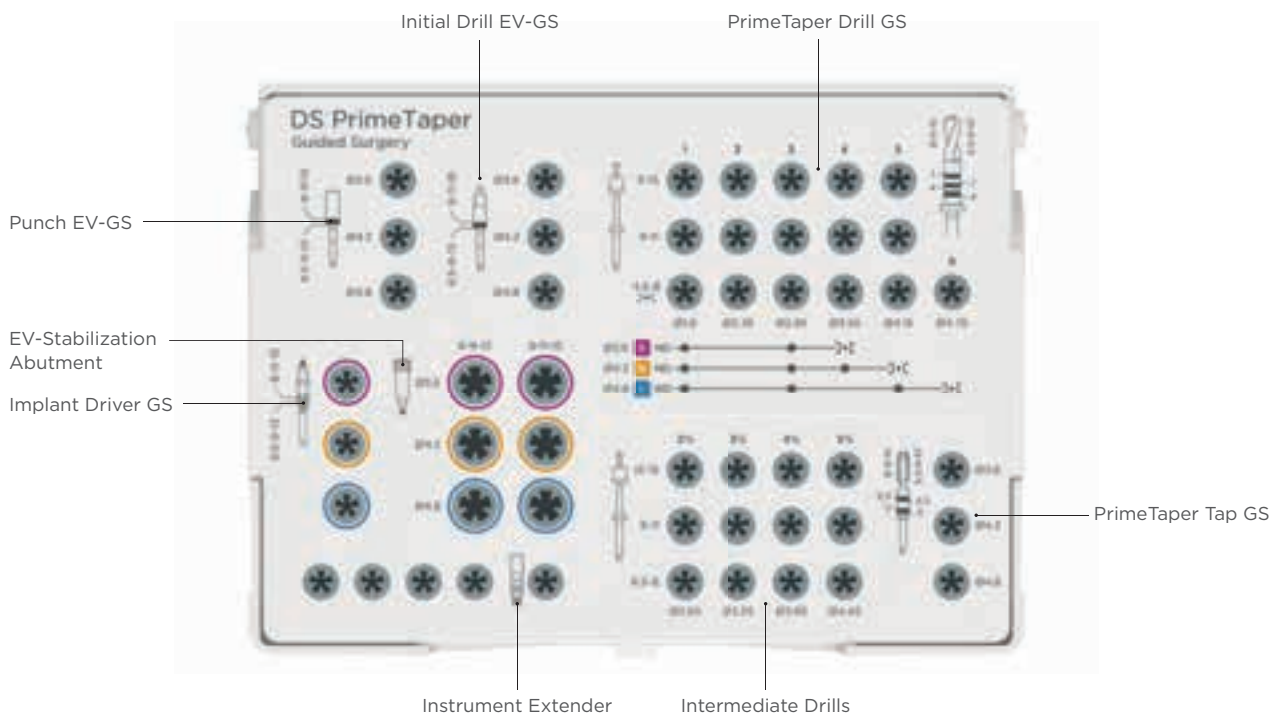

## 9. Simplant SAFE Guide

A custom-made Simplant SAFE Guide is fabricated from the patient's digital planning data using additive manufacturing with medical grade resin (stereolithography technique). This guarantees the exact and precise transfer of the planning into the patient's mouth.

### Types of support

#### Tooth-supported Simplant Guide

- For single tooth and partially edentulous cases when minimally invasive surgery is preferred
- Centrally printed by Dentsply Sirona in medical grade resin or delivered as Simplant Guide File with Simplant Guide Sleeves for local manufacturing
- A dentition scan (intra oral or lab scan) is required and a desired tooth setup and/or antagonist scan is recommended to provide the prosthetic information

#### Mucosa-supported Simplant Guide

- For fully edentulous cases when minimally invasive surgery is preferred
- Centrally printed by Dentsply Sirona in medical grade resin or delivered as Simplant Guide File with Simplant Guide Sleeves for local manufacturing
- (CB) CT Scan prosthesis required

#### Bone-supported Simplant Guide

- For larger partially or fully edentulous cases
- Positioned on the jawbone after raising a mucoperiosteal flap
- Centrally printed by Dentsply Sirona in medical grade resin
- To provide the prosthetic information, a (CB) CT Scan prosthesis is recommended

#### Dynamic guide sleeve position

The positions of the guide sleeves in the surgical guide are adjusted to the planned implant length. One drill length can accommodate different osteotomy depths. The guide sleeve position will be added by the planning software according to the planned implant length. Manual adjustments are not possible.

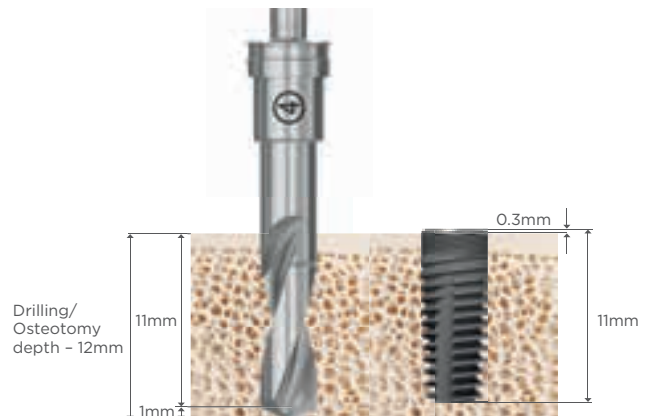
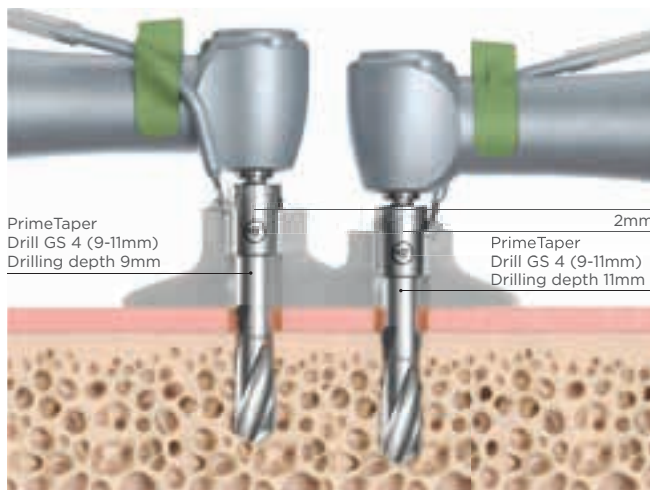

Consider during planning in the software that the osteotomy can reach up to 1.3mm deeper than the recommended placement of the implant. For the 6.5 mm long implant the Drilling/Osteotomy depth is 7 mm.

## Tooth-supported procedure

A tooth-supported surgical guide can be used either with a flapless technique or by raising a flap.



When placing multiple implants in a situation with a low number of remaining teeth or unfavorable structure of existing teeth, tooth-supported guides must also be stabilized with stabilization abutments. In such cases at least the first two implants must be prepared, inserted and provided with a stabilization abutment before drilling is carried out at other sites.

### Tooth-supported Simplant SAFE Guide

- Check the coverage of the guide base and correct it if necessary.
- Depending on the design of the guide, the criteria for bone- or mucosa-supported guides apply to the edentulous regions.
- Place the guide into the patient's mouth and check for a precise and stable fit.
- When there are few remaining teeth or instability of the guide, it is fixed according to the procedure for bone- or mucosa-supported surgical guides.

## Bone-supported procedure

A bone-supported surgical guide is used for edentulous and partially edentulous patients with more than three missing teeth.



### Bone-supported Simplant SAFE Guide

- Check the fit and the extension of the guide base.
- To guarantee a definite and stable fit, the base should only be as large as necessary.
- Place the guide into the patient's mouth and check for a precise and stable fit.
- Make sure the guide maintains its position in the jaw.
- If necessary use guide fixation screws to fix the guide into the jaw.

Excessive force on the surgical guide, e.g. excessive tightening of the fixation screws (osteosynthesis screws), tilting of instruments and excessive pressure should be avoided particularly at the fixing points. This may cause breakage of the guide making them unusable. Only use fixation screws where the guide design includes guide sleeves for fixation.

## Mucosa-supported procedure

Mucosa-supported surgical guides guarantee a minimally invasive procedure and are generally utilized for edentulous patients.

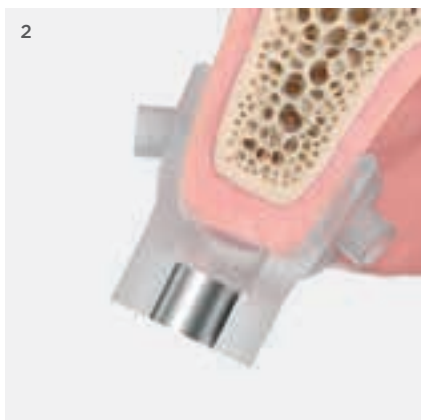
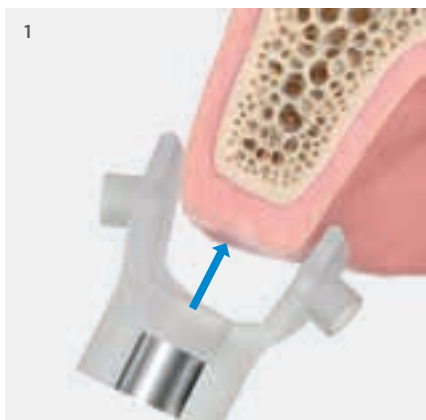

### Mucosa-supported Simplant SAFE Guide

- Check the fitting of the guide on the master cast. This must be large enough to guarantee a stable fit.
- Place the guide in the patient's mouth and check for a precise and stable fit.
- A bite index made from plastic or registration silicone, fabricated beforehand in the articulator, guarantees that the surgical guide records the same position as the scanning template.
- Fix the surgical guide vestibularly in the designated positions.
- Carefully close the patient's mouth and allow biting into the index.
- If required, use fixation screws palatally or lingually.

When placing multiple implants, mucosa-supported guides must be stabilized with stabilization abutments. At least the first two implants must be prepared, inserted and provided with a stabilization abutment before drilling is carried out at other sites. Hence, the surgical guide cannot be displaced or distorted between the further drilling processes.

## 10. Implant site preparation – Guided Surgery

In the following, the implant site for PrimeTaper EV Ø4.2 x 11mm is prepared for guided surgery by using the same steps as for conventional preparation. The transgingival procedure with a guide is described.



### Mucosal punching

- The mucosal punch is only required for flapless surgery.
- Insert the Punch EV-GS 4.2 into the guide. Start rotating and cut through the tissue until it lightly comes in contact with the bone.
- The correct position has been reached when depth marking of 8-11-15mm is flush with the top margin of the SAFE Guide.
- The maximum speed for the punch is 800 rpm.



### Initial drilling

- Use the Initial Drill EV-GS 4.2 to remove and to prepare the starting point for the first full-length drill.
- The correct position has been reached when the depth marking of 8-11-15 is flush with the top margin of the SAFE Guide.



### 1-Drill EV-GS

- Use the 1-Drill EV-GS of the planned implant length.
- Lock the drill sleeve in the first groove above the drill tip.
- Lower the drill sleeve into the guide sleeve of the surgical guide to the stop. Do not activate the rotation until this point.
- Drill without excessive pressure until reaching the depth stop (no intermittent drilling).
- The still forward rotating drill is withdrawn until reaching the locking position for the drill sleeve. The drill sleeve shall remain in the guide during this procedure.
- Stop rotating and carefully remove the drill with the attached drill sleeve out of the surgical guide.

Drilling, except for the Punch, should be performed at a maximum speed of 1500 rpm with profuse irrigation. Use the hole below the guide sleeve in the Simplant SAFE Guide for adequate cooling.



### Expansion drilling Drill 3 and 4

- After the pilot drilling, the implant site is successively prepared to the planned implant diameter and length using PrimeTaper Drills 3 and 4 GS.

Cutting instruments should be replaced after 10 uses or if they are damaged or blunt. Punches and drill sleeves are single use and must be replaced after surgery.

### Drilling protocol

Recommended drilling protocol for soft, medium and dense bone qualities (for more bone qualities, see page 15).

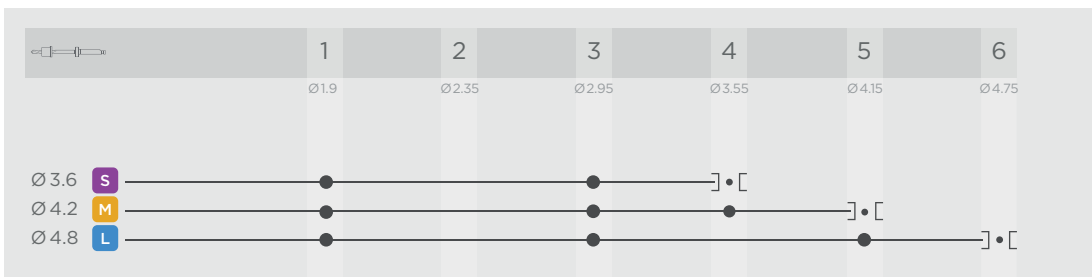

- Figures refer to drill numbers 1-6
- ] [ refers to cortical preparation only (mandatory)
- Adapt the cortical preparation to the individual thickness of the cortex
- The cortical preparation has to be performed with the PrimeTaper Drill GS for implant lengths 6.5-8mm. The depths of the preparation is indicated by the depth markings.
- Drilling to the 2mm marking, using the drill for cortical preparation " ] [ ", will ensure sufficient space for the MicroThread portion of the implant

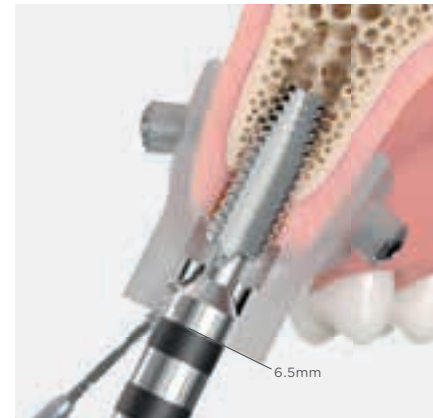

### Cortical preparation of the bone

#### 1mm thick cortex

- Cortical preparation is marked with this symbol ] [ in the drilling protocol.
- Use the 6.5-8mm length Drill GS 5
- Drill through the entire thickness of the cortical bone, in this case 1mm
- The 6.5-8mm drill have markings for 1-4mm depths depending on cortical thickness
- Drilling to 2mm marking will ensure sufficient space for the MicroThread portion of the implant

#### 3mm thick cortex

- Drill through the entire thickness of the cortical bone, in this case 3mm.

### Optional tapping in very dense bone

- Use the Tap GS after crestal preparation
- The maximum rotary speed is 25 rpm.
- Tap until reaching preferred depth
- The markings start with 6.5mm tapping depth measured when the marking is flush with the guide.
- Remove the tap from the osteotomy in a counterclockwise direction.

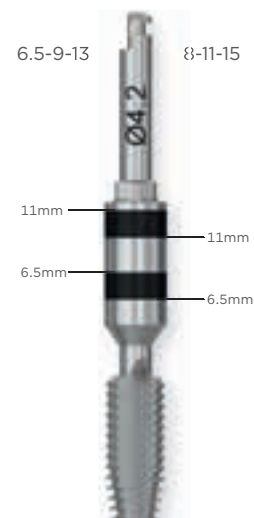
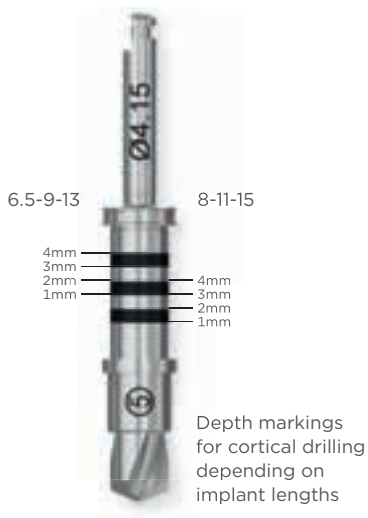

Since the tap does not have a depth stop, the visual control of the maximum preparation depth must be observed. If the tap is screwed in too deeply, there is a risk of damaging anatomical structures and nerves.

## 11. Implant installation – Guided Surgery

The following images show the placement of PrimeTaper EV Ø4.2 x 11mm.



### Implant installation

- Use the PrimeTaper Driver EV GS (M) to place the implant at 25 rpm and maximum 45 Ncm.
- The grooves indicate the implant installation depth.
- The correct groove in this case 8-11-15mm has to be flush with the surgical guide.

### Implant installation to final position

- Align one of the six notches of the implant driver with the index marking in the surgical guide. The marking is placed buccally as default.
- If the implant rotation has been individualized in the software, align with that moved marking in the guide
- The alignment between driver and guide ensures optimal placement of pre-surgically planned and produced Atlantis abutments. It also means that the implant rotation can be planned e.g. according to indexed angled stock abutments

### Securing the surgical guide with Stabilization Abutments

- This procedure is primarily intended for mucosa-supported surgical guides.
- Prior to inserting further implants, the stabilization abutment is inserted and secures the guide to prevent it from moving and rotating between preparations of multiple implant sites.
- At least the first two implants must be prepared, placed and provided with a stabilization abutment in succession before further implants are placed.

For correct placement of the PrimeTaper EV implant, only use the specific Implant Driver EV GS with Order No. 68017001, 68017002, 68017003.









## Notes

---

---

---

---

---

---

---

---

---

---

---

---

---

---

---

---

---

---

---

---

---

---

---

---

---

---

---

---

---

---



---

THE DENTAL  
SOLUTIONS  
COMPANY™

